

# Rhino<sup>®</sup>ceros

modeling tools for designers

Training Manual

Level 1

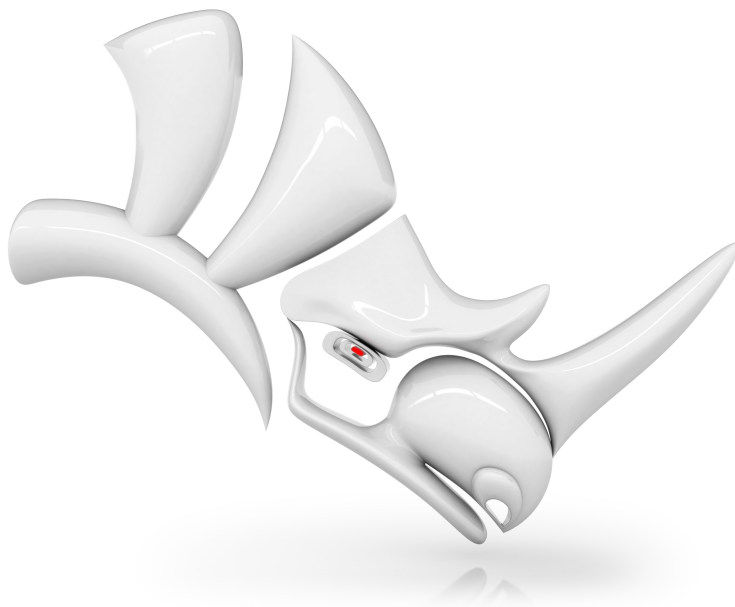

**Revised: 3/2/2023**

© Robert McNeel & Associates 2020

All Rights Reserved.

Printed in USA

Permission to make digital or hard copies of part or all of this work for personal or classroom use is granted without fee provided that copies are not made or distributed for profit or commercial advantage. To copy otherwise, to republish, to post on servers, or to redistribute to lists requires prior specific permission. Request permission to republish from: Publications, Robert McNeel & Associates, 3670 Woodland Park Avenue North, Seattle, WA 98103; FAX (206) 545-7321; e-mail [permissions@mcneel.com](mailto:permissions@mcneel.com).

**Content Credit:**

Mary Ann Fugier [mary@mcneel.com](mailto:mary@mcneel.com), Robert McNeel & Associates

Pascal Golay [pascal@mcneel.com](mailto:pascal@mcneel.com), Robert McNeel & Associates

Jerry Hambly [jerry@mcneel.com](mailto:jerry@mcneel.com), Robert McNeel & Associates

Vanessa Steeg [vanessa@mcneel.com](mailto:vanessa@mcneel.com), Robert McNeel & Associates

Corrections or additions: please email Mary Ann Fugier [mary@mcneel.com](mailto:mary@mcneel.com).

**Proofing Credit:**

Bob Koll, [bobkoll@mcneel.com](mailto:bobkoll@mcneel.com), Robert McNeel & Associates

Lambertus Oosterveen [l.oosterveen@home.nl](mailto:l.oosterveen@home.nl)

Vanessa Steeg [vanessa@mcneel.com](mailto:vanessa@mcneel.com), Robert McNeel & Associates

Cécile Lamborot [cecile.lamborot@mcneel.com](mailto:cecile.lamborot@mcneel.com), McNeel Europe, Translator

**Additional Credit:**

Phil Cook, Simply Rhino Limited, UK, [www.simplyrhino.co.uk](http://www.simplyrhino.co.uk) for the exercises on SmartTrack and Constraints.

Bob Koll, [bobkoll@mcneel.com](mailto:bobkoll@mcneel.com), Robert McNeel & Associates, for Gumball Puzzle and CPlane Exercises.

Doaa Alsharif, [doaa@mcneel.com](mailto:doaa@mcneel.com), Robert McNeel & Associates, for Chair Designs and Duck Cafe Renderings.

Giuseppi Massoni, [giuseppi@mcneel.com](mailto:giuseppi@mcneel.com), Robert McNeel & Associates, for Grasshopper exercise concept.

Julie Ann Pedalino, [Pedalino Bicycles](#) for the bicycle image used in the Grasshopper exercise.

Steven Jarvis, Professor of Sculpture, School of Fine Arts, [Savannah College of Art and Design®](#) for the link to the bicycle video in the Grasshopper exercise.



# Table of Contents

Table of Contents .....	iii
<b>Chapter 1 - Introduction</b> .....	<b>1</b>
Software .....	1
Target audience: .....	1
Duration: .....	1
Objectives .....	2
<b>Chapter 2 - Getting the Models</b> .....	<b>1</b>
Option 1: Download files separately .....	1
Option 2: Download all files at once .....	1
<b>Chapter 3 - What is Rhino?</b> .....	<b>3</b>
Object types .....	3
<b>Chapter 4 - The Rhino Interface</b> .....	<b>7</b>
Exercise 4-1 The Rhino Interface .....	7
The Rhino window .....	7
Window title .....	7
Menu .....	7
Command window .....	8
Command prompt .....	8
Toolbar group .....	9
Toolbar (Sidebar) .....	9
Viewports .....	10
Viewport title and menu .....	11
Viewport tabs .....	11
Osnap control .....	11
Status Bar .....	11
Panels .....	12
Help and Help panel .....	12
Command-line history .....	14
Mouse actions .....	14
Exercise 4-2 Getting started .....	15
Navigating the model .....	18
Move objects .....	20
Copy objects .....	21
Change the view of your model .....	28
Pan and zoom .....	28
Reset the view .....	29
Display options .....	30
Exercise 4-3 Practice with Display Options .....	30
Start drawing .....	32
Exercise 4-4 Draw lines .....	32
On your own .....	37
Save your work .....	38
<b>Chapter 5 - Modeling helpers</b> .....	<b>39</b>
Modeling aids now .....	39
Modeling aids later .....	39
Exercise 5-1 Modeling aids in use .....	40
Summary of Function Keys .....	41
Exercise 5-2 Practice using selection options .....	43

Object visibility and locking .....	47
Layers .....	48
Exercise 5-3 Working with layers .....	48
Exercise 5-4 Practice with Layers .....	51
<b>Chapter 6 - Precision modeling .....</b>	<b>53</b>
Coordinate entry .....	53
Exercise 6-1 Set up a model .....	53
Distance and angle constraint entry .....	56
Exercise 6-2 The Arrow .....	57
Exercise 6-3 The V-block .....	61
Object Snaps .....	63
Exercise 6-4 Use osnaps .....	63
Analysis commands .....	66
Exercise 6-5 Analyze the model .....	66
Additional modeling aids .....	69
Exercise 6-6 Use SmartTrack .....	69
Introduction to construction planes .....	74
Exercise 6-7 Using construction planes .....	77
Exercise 6-8 The Chair .....	80
Draw circles with precision .....	90
Exercise 6-9 Practice with Circles .....	91
Exercise 6-10 Use circle commands with object snaps .....	95
Exercise 6-11 Drawing Arcs: CSA, SED, SER .....	97
Exercise 6-12 The Mechanical Arm .....	100
Modeling Skills to Consider .....	101
Ellipses and polygons .....	102
Exercise 6-13 The Toy Table .....	102
Free-form curves .....	108
Exercise 6-14 Practice drawing curves .....	108
Helix and Spiral .....	110
Exercise 6-15 Helix and spiral curves .....	110
Draw free-form curves .....	113
Exercise 6-16 The Toy Screwdriver .....	113
<b>Chapter 7 - Editing geometry .....</b>	<b>119</b>
Fillet .....	119
Exercise 7-1 Filleting curves .....	119
Curve blends .....	124
Loft .....	126
Exercise 7-2 Lofting curves .....	127
Chamfer .....	129
Exercise 7-3 Chamfer lines .....	129
Exercise 7-4 Practice with Fillet and Chamfer .....	131
Transform Commands: Move .....	132
Exercise 7-5 Transform Commands .....	132
Copy .....	134
Undo and Redo .....	134
Rotate .....	134
Group .....	135
Mirror .....	136
Join .....	136

Scale .....	137
More on gumball .....	139
Exercise 7-6 Gumball menu .....	139
Exercise 7-7 The 3D Puzzle .....	141
Trim .....	147
Exercise 7-8 Trim curves .....	147
Split .....	148
Extend .....	150
Exercise 7-9 Extend curves .....	150
Offset .....	154
Exercise 7-10 Offset curves .....	154
Array .....	160
Exercise 7-11 Array .....	160
Exercise 7-12 Practice - The Gasket .....	163
Exercise 7-13 Practice - The Cam .....	164
Exercise 7-14 Practice - The Link .....	165
<b>Chapter 8 - Point editing .....</b>	<b>167</b>
About control points, edit points, and knots .....	167
Control point editing .....	167
Exercise 8-1 Edit control points .....	167
Nudge Controls .....	171
Exercise 8-2 Change the nudge settings .....	171
Exercise 8-3 Practice with curves and control point editing .....	174
<b>Chapter 9 - Creating Deformable Shapes .....</b>	<b>179</b>
Exercise 9-1 The Rubber Duck .....	179
<b>Chapter 10 - Modeling with solids .....</b>	<b>197</b>
Exercise 10-1 Model a bar with text .....	197
<b>Chapter 11 - Creating surfaces .....</b>	<b>207</b>
Simple Planar Surfaces .....	207
Exercise 11-1 Closed polysurface box .....	207
Surfaces from Extruded curves .....	210
Exercise 11-2 - Retro handset .....	210
Lofted surfaces .....	219
Exercise 11-3 Loft surfaces— The Canoe .....	219
Revolved surfaces .....	229
Exercise 11-4 Revolve -The Vase .....	230
Rail Revolve .....	232
Exercise 11-5 Rail Revolve—Heart and Star .....	232
One-rail sweeps .....	233
Exercise 11-6 One-rail sweeps .....	234
Two-rail sweeps .....	237
Exercise 11-7 Two-rail sweeps—Rear-view mirror .....	237
Network Surface .....	240
Exercise 11-8 Curve Network - The Side Panel .....	240
Exercise 11-9 The Table .....	241
Modeling techniques—Toy hammer .....	244
Exercise 11-10 The Hammer .....	244
Precision modeling .....	255
Exercise 11-11 — The Squeeze bottle .....	255

<b>Chapter 12 - Annotating your model</b> .....	<b>271</b>
Dimensions .....	271
Dimension types .....	271
Annotating the model .....	271
Exercise 12-1 Dimension the part .....	272
Making a 2-D drawing from a 3-D model .....	277
Exercise 12-2 Practice making a 2-D drawing .....	277
<b>Chapter 13 - Importing and exporting</b> .....	<b>281</b>
Importing other file formats into Rhino .....	281
Exporting Rhino File Information .....	281
Exercise 13-1 Export a model to a mesh format .....	281
<b>Chapter 14 - Rendering</b> .....	<b>283</b>
Materials and other features .....	283
Exercise 14-1 Practice rendering the toy screw driver .....	283
Add textures .....	292
Use the ground plane .....	299
Setting the Rendering Resolution .....	301
Rendering Metals .....	302
Raytraced Mode .....	303
Rendering with Sun .....	304
Exercise 14-2 Rendering the Gazebo .....	304
<b>Chapter 15 - Printing and Layouts</b> .....	<b>311</b>
Printing .....	311
Exercise 15-1 Printing the model .....	311
Exercise 15-2 Layouts .....	311
Scaling and locking details on a layout .....	317
Exercise 15-3 Layout the Frigate .....	317
<b>Chapter 16 - Intro to Grasshopper</b> .....	<b>323</b>
The Grasshopper UI .....	323
Exercise 16-1 The Bike Wheel .....	327
<b>Chapter 17 - Transforming solids</b> .....	<b>337</b>
Flow along surface .....	337
Exercise 17-1 Flow solid text .....	337
Exercise 17-2 Flow logo to penguin .....	340
Flow .....	343
Exercise 17-3 Making a Ring with Flow .....	343

# Chapter 1 - Introduction

---

This course guide was compiled to accompany the Rhinoceros Level 1 instructor-lead training session.

Level 1 training shows you how to produce 3-D models using NURBS geometry and arrange models for export, annotation and plotting.

In class, you will receive information at an accelerated pace. For best results, practice at a Rhino workstation between class sessions, and consult the online Help resources for additional information.

## Software

The training guide was designed for use with **Rhinoceros 6** or later.

The training files have been updated to open with **Rhinoceros 6** or later.

### Using with Rhino for Mac

The training guide was written with **Rhino for Windows**, and therefore there will be slight differences if you use **Rhino for Mac**.

The main differences are:

- Any instructions in the training guide that include the **Control** key, can be replace with the **Command** key to work on **Rhino for Mac**.
- **System Options** command on Windows is found on the Mac under the **Rhino** menu and **Settings** or **Preferences** depending on Mac OS.
- **Document Options** on Windows is found on the Mac under the **File** menu and it is called **Settings**.
- When a command is active, the command window opens and overlays the left sidebar.

Commands names, menu locations and general Rhino modeling techniques apply equally whether Rhino is running on a Windows or a Mac operating systems.

## Target audience:

The training guide presents topics, commands, and procedures that are important for every Rhino user.

The training guide will offer exercises and examples with common objects that allow the concepts to be thoroughly covered for all students, regardless of field or industry.

## Duration:

- The training guide consists of more than 24 hrs of training.
- The training can be presented in three full-day, six half-day sessions or adapted for a custom schedule.
- Instructor should prepare by choosing which exercises are to be presented during class and which exercise work will be assigned as homework.
- High schools or secondary schools may present the materials over a full semester. For a curriculum guide and other ideas on teaching Rhino, go to [Rhino in Education](#) web site for support.

## Objectives

In Level 1, you learn how to:

- Use the features of the Rhino user interface
- Customize your modeling environment
- Create basic graphic objects—lines, circles, arcs, curves, solids, and surfaces
- Model with precision using coordinate input, object snaps, and SmartTrack™ tools
- Modify curves and surfaces with edit commands and gumball
- Use control point editing to modify curves and surfaces
- Analyze your model
- Display any portion of the model
- Export and import models to and from various file formats
- Render the model using Rhino Render
- Dimension and annotate model with text and hatch
- Use layouts to arrange views of model on paper for printing

### Schedule A: Three classroom days

Day 1	Topic
8:00 am – 10:00 am	Introduction, Rhino interface
10:00 am – 12:00 pm	Rhino interface, panning, and zooming
12:00 pm – 1:00 pm	Lunch
1:00 pm – 3:00 pm	Creating geometry
3 :00 pm – 5:00 pm	Creating geometry
Day 2	Topic
8:00 am – 10:00 am	Editing
10:00 am – 12:00 pm	Editing
12:00 pm – 1:00 pm	Lunch
1:00 pm – 3:00 pm	Editing
3:00 pm – 5:00 pm	Control point editing, modeling with solids
Day 3	Topic
8:00 am – 10:00 am	Surfacing
10:00 am – 12:00 pm	Surfacing
12:00 pm – 1:00 pm	Lunch
1:00 pm – 3:00 pm	Modeling practice
3:00 pm – 5:00 pm	Import / export, rendering, dimensioning, printing, customization

**Schedule B: Six half days (on-line training)**

<b>Session 1</b>	<b>Topic</b>
9:00 am – 10:45 am	Introduction, Rhino interface
10:45 am – 11:00 am	Break
11:00 am – 12:45 pm	Rhino interface, panning & zooming
<b>Session 2</b>	<b>Topic</b>
9:00 am – 10:45 am	Creating geometry
10:45 am – 11:00 am	Break
11:00 am – 12:45 pm	Creating geometry
<b>Session 3</b>	<b>Topic</b>
9:00 am – 10:45 am	Editing
10:45 am – 11:00 am	Break
11:00 am – 12:45 pm	Editing
<b>Session 4</b>	<b>Topic</b>
9:00 am – 10:45 am	Editing
10:45 am – 11:00 am	Break
11:00 am – 12:45 pm	Control point editing, modeling with solids
<b>Session 5</b>	<b>Topic</b>
9:00 am – 10:45 am	Surfacing
10:45 am – 11:00 am	Break
11:00 am – 12:45 pm	Surfacing
<b>Session 6</b>	<b>Topic</b>
9:00 am – 10:45 am	Modeling practice
10:45 am – 11:00 am	Break
11:00 am – 12:45 pm	Import / export, rendering, dimensioning, printing, customization





# Chapter 2 - Getting the Models

---

To access the models that this training guide uses, there are two primary options.

The first option, Rhino will download each file when you select it from the Tutorials panel.

The second option, you may download all the files as a compressed zip and unzip them into a folder.

**Note:** You will need basic file management skills to use Rhino effectively on your computer. If you are not familiar with creating folders, copying, renaming or deleting files, stop now and find training to establish these skills.

## Option 1: Download files separately

If you are new to file management on Windows, this is the better option. If you prefer to avoid all the individual file downloads, then continue with *Option 2: Download all files at once*.

1. Create a folder on your **Desktop** or in your **My Documents** folder, or another location in which you have full rights.
2. Name the folder **Level 1 Training** or other name that you will remember.
3. Open the **Rhino** application.
4. From the **Help** menu, click **Learn Rhino**, and click **Tutorials and Samples**.

The **Tutorials** panel will appear.

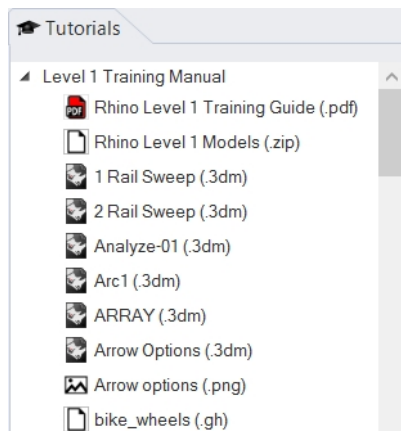

5. Navigate to the **Level 1 Training Manual** folder, scroll to the model **What\_is\_Rhino.3dm**.
6. Double-click to load the contents of the file in the Rhino application.  
This will load the contents of the file into a new Rhino model.
7. At the end of each exercise, save the file to the folder you created in the previous steps..
8. Repeat these steps at the beginning of each exercise that directs you to open an existing file.
9. For exercises that require image files, download the required files and save them into the same folder that you have saved your 3dm model file in step 7. You will need to repeat this for each image file.  
For example, **Render.3dm** will require a file **Wood .jpg** to also be downloaded to complete the exercise. Both are on the **Tutorials** panel under **Level 1 Training**. Keep it simple and save it to the same folder as the model, however, it can go anywhere that you have rights to save.

## Option 2: Download all files at once

You will download a set of existing models and files that are used in this training guide.

Unzip the files in a Training folder. When you are asked to open a file, navigate to that folder.

1. Create a folder on your **Desktop** or in your **My Documents** folder, or another location in which you have full rights.
2. Name the folder **Level 1 Training Manual** or other name that you prefer.
3. Open the **Rhino** application.

4. From the **Help** menu, click **Learn Rhino**, and click **Tutorials and Samples**.  
The **Tutorials** panel will appear.

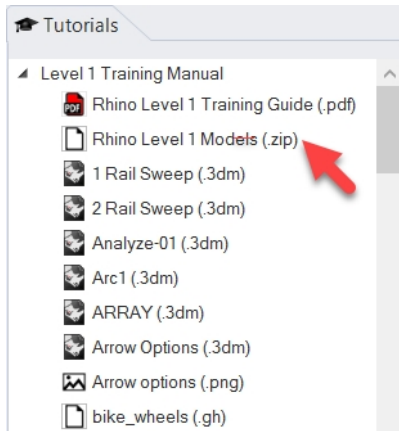

5. Navigate to the **Level 1 Training** folder.
6. Double-click the **Rhino Level 1 Models (.zip)** to download it.
7. **Unzip** the downloaded file into the folder that you created in the previous steps.
8. In the Rhino application, on the **File** menu, click **Open**.
9. In the **Open** dialog box, navigate to the **Level 1 Training** folder and **Open** the model **What\_is\_Rhino (.3dm)**  
This model contains all of the objects that we will be introducing you to in this section: surfaces, polysurfaces, solids, free form curves, circles, arcs, meshes, lights, dimensions and more.

# Chapter 3 - What is Rhino?

Rhinoceros is 3-D modeling software is primarily a surface-modeling tool, but has many related features. Many Rhino designers use only a small portion of what Rhino has to offer, while others need and use a lot more and even use plug-ins to extend the functionality; it depends on what the individual user is trying to accomplish with the application. Even very experienced users will find new and useful tools they were previously unaware of. This introduction provides a broad overview of various elements that you will encounter while using Rhino to get your work done.

## Object types

What does *surface modeler* mean?

Rhino has tools to create and edit various types of objects, of which surfaces are one. A surface in Rhino refers to an infinitely thin, infinitely flexible, mathematically-defined digital membrane. This is different from a solid modeler that deals with solid objects or a mesh modeler that deals with polygon meshes.

### Surfaces

*Surfaces* are represented on screen by either some outline curves plus some interior curves, called *isocurves*, or by a shaded picture that makes a surface appear to have some substance and to show light and shading. How surfaces are painted on the screen depends on the display mode in the viewport and does not affect the surface in any way.

The important thing to remember about surfaces is that they are defined with great precision at every point by complex math formulas; they are not approximations.

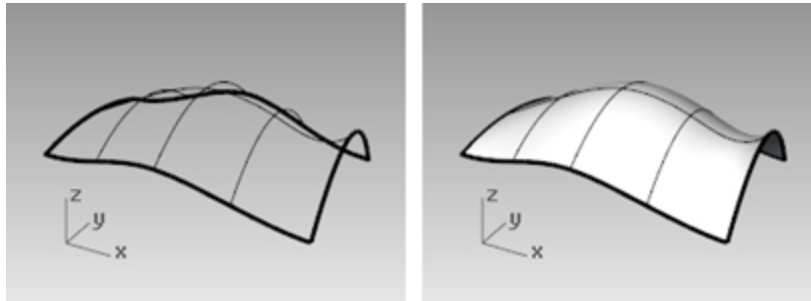

A surface, shown in wireframe (left) and shaded (right) views.

### Polysurfaces

Rhino also has objects that consist of two or more surfaces joined together. This is possible when the edge of one surface is located very close to the edge of another surface. We call these joined surfaces *polysurfaces*. Some restrictions apply to editing polysurfaces, so Rhino makes it easy to extract the individual surfaces from polysurfaces and join them back together.

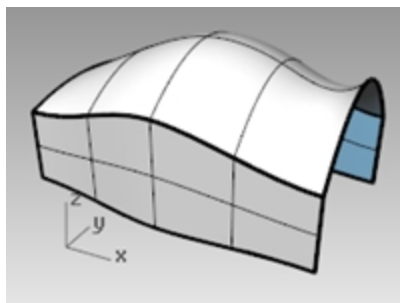

A polysurface in shaded view.

## Solids

If you need your objects to have volume, there are two ways to accomplish this. A single surface can close around itself to enclose a volume. Spheres and ellipsoids are examples of this type of surface.

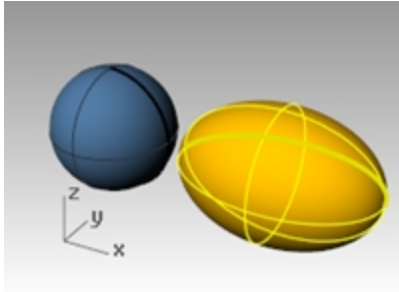

*Single-surface closed solid objects.*

Single surfaces joined to enclose a space also form a solid. A box is an example of this type of object. We call these objects *solid*, but it is important to remember that there is nothing inside them. They are volumes in space enclosed by the infinitely thin surfaces. If you remove one side of a box, and look inside you will see the backs of the surfaces.

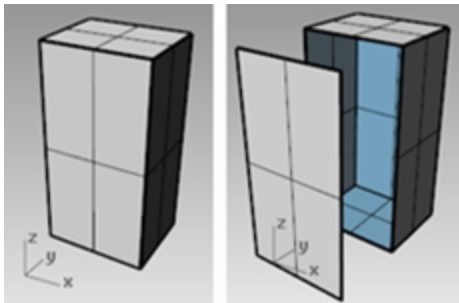

*Closed (solid) and open polysurface.*

## Lightweight extrusion objects

Another object type that is related to a polysurface and a solid is the lightweight extrusion object. Lightweight extrusion objects are defined by a profile curve and a direction and distance. Extrusion objects use less memory, mesh faster, and save a smaller file size than polysurfaces.

Commands like **Box**, **Cylinder**, **Pipe**, and **ExtrudeCrv** create lightweight extrusion objects by default.

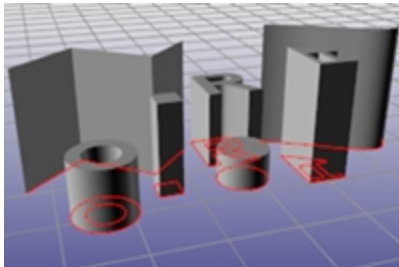

*Lightweight extrusion objects.*

## Curves

In Rhino terminology, the word *curve* includes lines, polylines (a series of straight-line segments joined end to end), arcs, ellipses, circles, or free-form curves that are generally smooth. *Polycurves* are made up of two or more curves joined end to end.

Curves are used as input for creating and editing surfaces. For example, you can trim an object with a curve, but they may be useful in themselves as well, as in making a 2-D drawing of a 3-D model or as construction geometry. You can derive and extract curves from surfaces. For example, all surfaces have edges, and it is possible to extract an edge curve. You can also extract surface isocurves.

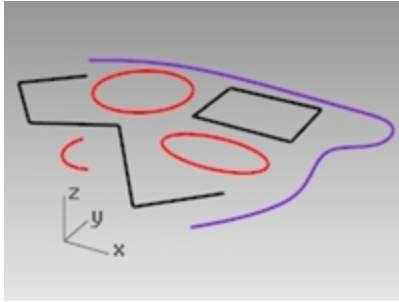

*Curves.*

## Polygon meshes

*Polygon meshes* are sometimes used to depict the same type of objects as surfaces but there are important differences. Polygon meshes consist of a number of vertex points in space connected by straight lines. These straight lines form polygons, which are closed loops of three or four sides.

One important thing to know about polygon meshes is that the 3-D data only exists for these vertex points; the space between these points is not considered. Dense meshes are more accurate than very loose ones, but not as accurate as surfaces.

Meshes have their place in 3-D NURBS modeling. For example, if you look at a surface in a shaded viewport, what you see is actually a polygon mesh derived from the surface for the purposes of making an image on screen. You can export mesh data for rapid-prototyped parts.

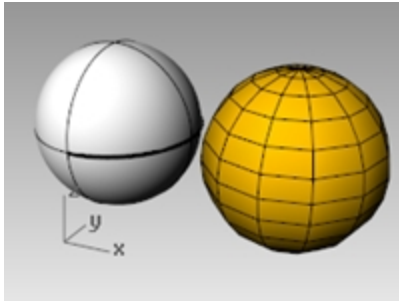

*A sphere surface and mesh sphere object.*

## Other Objects

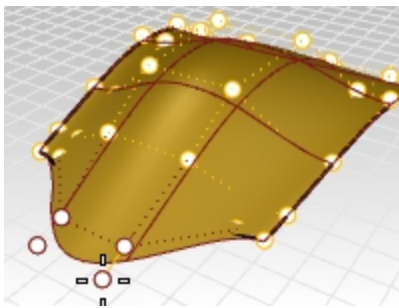

*Control points* are objects that can be manipulated in order to edit the shape of the parent object- they look like point objects but are not the same thing. Control points can be turned on and off for eligible objects.

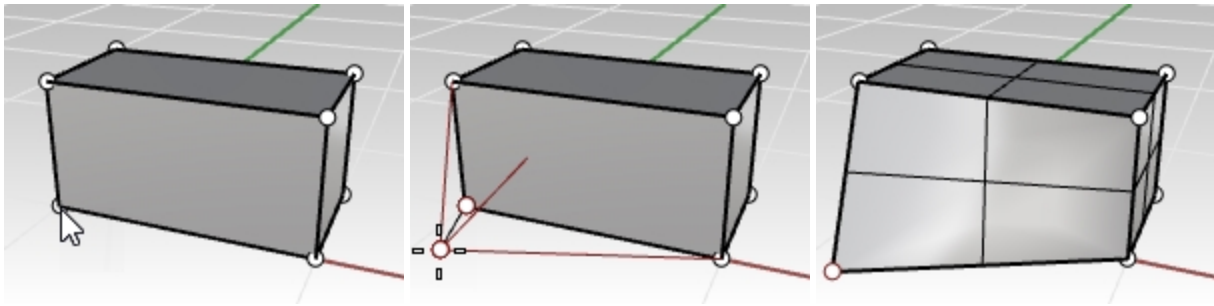

While *polysurfaces* do not have control points, they can be manipulated with Solid Points.

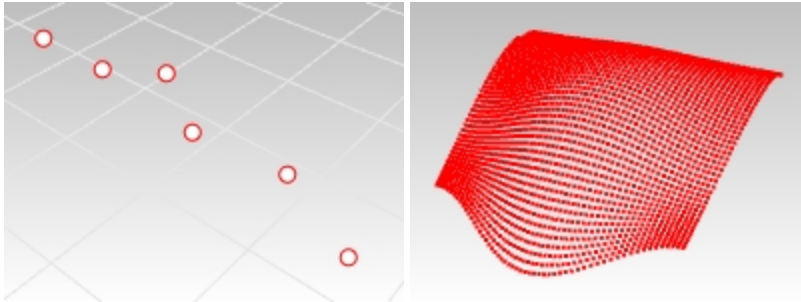

*Point object* marks a 3-D location in space. *Point clouds* are collections of point objects.

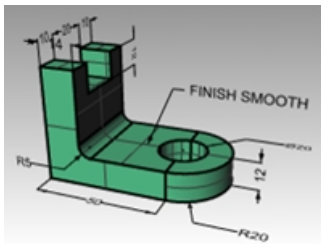

*Annotation objects* such as text and dimensions.

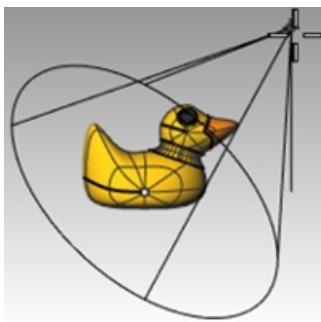

*Lights* which are used to help create renderings of the objects in the file.  
*Plug-ins*, or add-on programs, can also add their own object types to Rhino.

# Chapter 4 - The Rhino Interface

Before learning individual tools, we will get acquainted with the Rhino interface. The following exercises examine the interface elements used in Rhino: the Rhino window, viewports, menus, toolbars, panels and dialog boxes.

There are many ways to access the commands in Rhino—the keyboard, menus, and toolbars. We will focus on the menus in this class.

## Exercise 4-1 The Rhino Interface

- ▶ On the Windows desktop, double-click the Rhino icon.

### The Rhino window

Rhino divides its screen into areas that supply information or prompt you for input.

The image below illustrates some of the major features of the Rhino window.

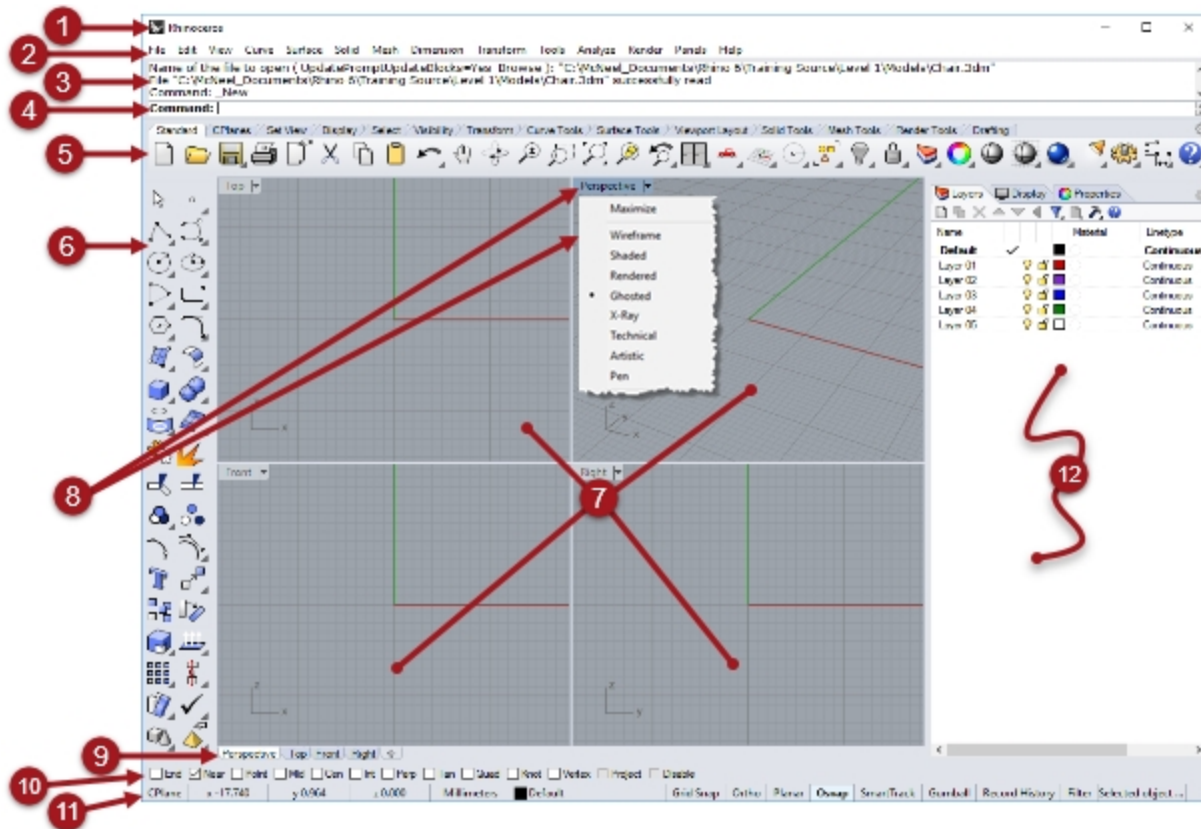

#### 1 Window title

Displays the current model's file name and file size.

#### 2 Menu

Groups Rhino commands by function.

### 3 Command window

Displays the previous commands. Text from this area can be copied and pasted into the command-line prompt, macro editor, button command, or any application that accepts text. You can dock the command window at the top or the bottom of the screen or it can float anywhere.

The **Command window** shows two lines by default. To open a separate window that displays the command history, press **F2**. You can select and copy text in the **Command History** window to the Clipboard.

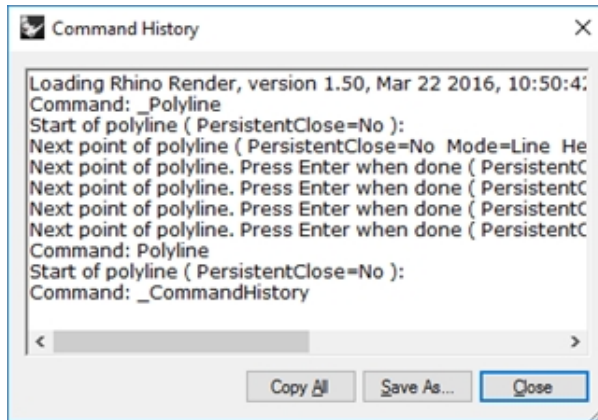

### 4 Command prompt

Use the command-line to type commands, click command options, type coordinates, type distances, angles, or radii, type shortcuts, and view command prompts.

To enter information typed at the command-line, press **Enter**, **Spacebar**, or right-mouse click over a viewport.

#### Autocomplete command name

Type the first letter of a command name to activate the autocomplete command list. As you type letters in the command-line, the command name that includes those letters will autocomplete and display in a drop down menu. Press **Enter** to activate the command once the full command name appears or left-click on the command in the list to start it.

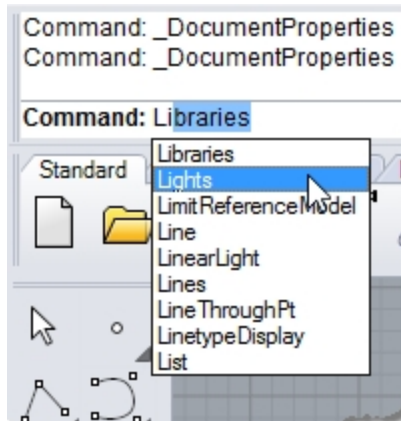

#### Command options

Command options change how a command acts. For example, when you draw a circle, the circle is normally drawn on the active construction plane. The **Circle** command has several options including **Vertical** and **AroundCurve**.

To use a command option, click the option name, or type the underlined letter of the option or the whole option name.

#### Choose a command option

1. Type **Circle**  
As soon as you have typed enough letters to uniquely identify the command, the **Circle** command automatically completes at the prompt.
2. Press the **Enter** key or click the command name in the list.



- The options for the **Circle** command appear:  
**Center of circle:** Deformable, Vertical, 2Point, 3Point, Tangent, AroundCurve, FitPoints
- To draw a circle vertical to the active construction plane, use the **Vertical** option.  
Click **Vertical**, or type **V**.

## Repeat the last command

Many tasks in Rhino are repetitive. You might want to move or copy several objects, for example. Methods for repeating commands are provided.

### To repeat the last command

- Press the **Enter** key when no command is active.
- In addition to pressing the **Enter** key on your keyboard, you can press the Space bar or click the right mouse button in a viewport.  
These all perform the same function.

### Note:

- Some commands, such as **Undo** and **Delete** do not repeat. Instead, the command prior to these commands is repeated. This prevents you from accidentally undoing too many commands or deleting objects accidentally.
- You can define the list of commands that do not repeat.
- For example, you may want to repeat the command that you were using before undoing a mistake with the **Undo** command. For this reason, **Undo** can be added to the list of commands that never repeats.
- Commands that you do not want to repeat are added to the text box under **Never repeat these commands** in **Options** on the **General** page.

### Use recent commands

- Right-click  the command-line to view recently used commands.

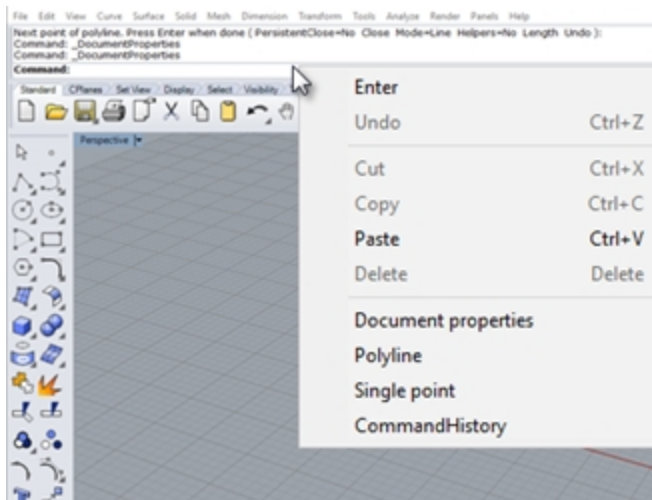

- To repeat the command, select it from the pop-up menu.  
The number of commands listed is set in Rhino Options. The default limit is twenty commands. When you use your twenty-first command the first one drops off the list.

## Cancel a command

To cancel a command, press **Esc** or enter a new command from a button or a menu.

## 5 Toolbar group

A collection of tabbed toolbars.

## 6 Toolbar (Sidebar)

Contain graphical icons for initiating commands.

Rhino toolbars contain buttons that provide shortcuts to commands. You can float a toolbar anywhere on the screen, or dock it at the edge of the graphics area.

Rhino starts up with the **Standard** toolbar group docked above the graphics area and the **Main** toolbar as the sidebar on the left.

## Tooltips

Tooltips tell what each button does. Move your pointer over a button without clicking it. A small tag with the name of the command appears. In Rhino, many buttons can execute two commands. The tooltips indicate which buttons have dual functions.

For example:

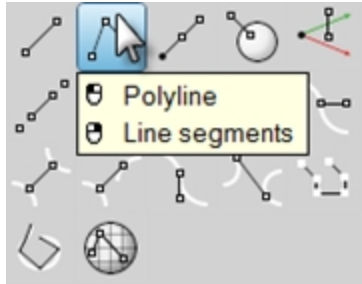

**To access the command on the top line**

- ▶ Click the icon with the left mouse **button**.



**To access the command on the bottom line**

- ▶ Click the toolbar button with the right mouse **button**.

## Cascading toolbars

A button on a toolbar may include other command buttons in a cascading toolbar. Usually the cascading toolbar contains variations on the base command.

Buttons with cascading toolbars are marked with a triangle in the lower right corner. To open the cascading toolbar, hover over the triangle and click. The tooltip [  Cascade "xxx" ] appears.

For example, the **Lines** toolbar is linked to the **Main** sidebar. After the cascading toolbar is open, you can click any of the buttons on the toolbar to start a command.

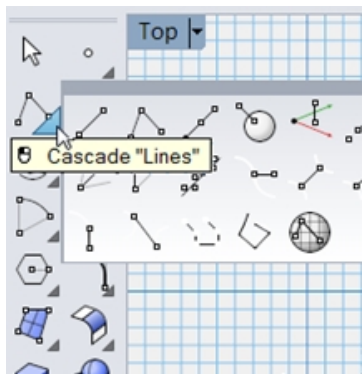

## 7 Viewports

The Rhino graphics area includes the viewports. You can customize number and position of the viewports.



Displays the Rhino working environment including object display, viewport title, background, construction plane grid, world axis icon.

Viewports are windows in the graphics area that show you views of your model. To move and re-size viewports, drag the viewport title or borders. From the viewport title menu, you can create new viewports, rename viewports, and use predefined viewport configurations.

## 8 Viewport title and menu

The viewport title appears in the upper left corner of each viewport.

The viewport title offers a shortcut for viewport actions:

-  Click the title to make the viewport current.
-  Double-click the title to maximize the viewport or to return it to its previous size.
-  Right-click the menu to display the viewport title menu.

You can also click the down arrow on the viewport title to display the menu.

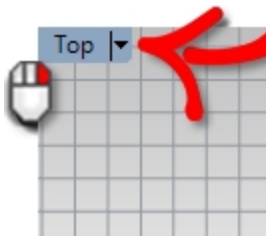

## 9 Viewport tabs

You can also display the viewport titles in tabs. The highlighted tab designates the active viewport. Tabs make it easy to switch between viewports when using maximized or floating viewports.

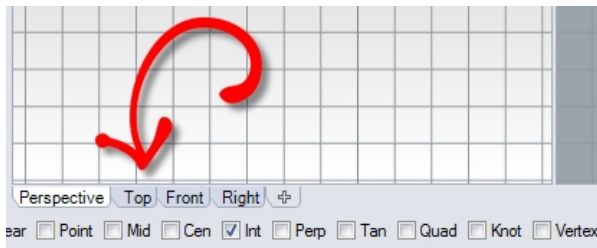

*The tabs are located below the graphics area.*

## 10 Osnap control

Contains persistent object snap toggles.

## 11 Status Bar

Displays the current coordinate system, the current location and delta of the cursor, and the Status Bar panes.

The Status Bar is located at the bottom of the Rhino window.

*Tip:* If the Status Bar is not visible, press **Alt** key. The **Alt** key toggles the visibility of the status bar.

CPlane	x	y	z	Inches	<input checked="" type="checkbox"/> Layer	Grid Snap	Ortho	Planar	Osnap	SmartTrack	Gumball	Record History	Filter	Info
--------	---	---	---	--------	---	-----------	-------	--------	-------	------------	---------	----------------	--------	------

### Status Bar options

- CPlane/World** The construction plane/world coordinates toggle.
- x** The mouse cursor x location.
- y** The mouse cursor y location.
- z** The mouse cursor z location.
- Units/Delta** The current units setting.  
During drawing commands, displays the distance from last picked point to the current location.

<b>Layer</b>	If objects are selected, the <b>Layer</b> pane displays the layer of the selected objects. If no objects are selected, the <b>Layer</b> pane displays the current layer. Click the <b>Layer</b> pane to access quick controls for setting the selected objects' layer or to change layer visibility and status.
<b>Grid Snap</b>	Click the <b>GridSnap</b> pane to toggle Grid Snap.
<b>Ortho</b>	Click the <b>Ortho</b> pane to toggle <b>Ortho</b> mode.
<b>Planar</b>	Click the <b>Planar</b> pane to toggle <b>Planar</b> mode.
<b>Osnap</b>	The <b>Osnap</b> control lets you select which object snaps are currently in effect. Click the <b>Osnap</b> pane to toggle the display of the Osnap control.
<b>SmartTrack</b>	Click the <b>SmartTrack</b> pane to toggle <b>SmartTrack</b> mode.
<b>Gumball</b>	Click the <b>Gumball</b> pane to toggle auto <b>Gumball</b> mode.
<b>Record History</b>	Click the <b>Record History</b> pane to toggle history recording on/off state.
<b>Filter</b>	Click the <b>Filter</b> pane to open the Selection Filter control.
<b>Info</b>	Click the <b>Info</b> pane to display information about the current Rhino session. The <b>Info</b> pane cycles through the list of specified categories.

## 12 Panels

Many Rhino controls are contained in tabbed panels. The panels are docked to the right side of the Rhino screen by default. However, they can be dragged and floated anywhere.

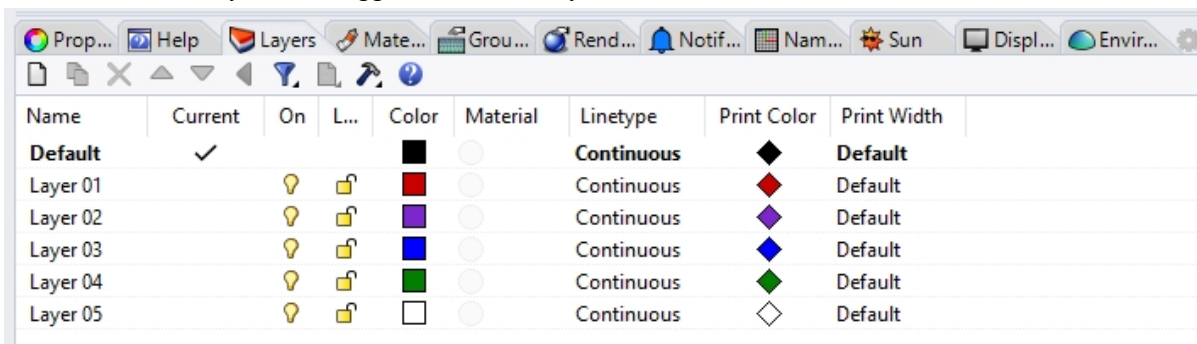

### Open panels

- ▶ On the **Panels** menu, click the name of the panel you want to open.
- Or
- Right-click  a panel tab.

Panels that you will work with in Level 1 training are:

- Display
- Layers
- Help
- Named CPlanes
- Notes
- Properties
- Web browser

**Note:** Positioning the mouse over the tabs allows the mouse wheel to scroll through the tabs.

## Help and Help panel

Press **F1** at any time to access Rhino Help. In addition to finding information about each command, Rhino help has conceptual information as well as many examples and graphics to help you complete your model. When you are confused or unsure about what to do, the first place you should look is the help file. You can also access help for a specific command by starting the command and press **F1**.

In addition, the **CommandHelp** command displays the help topics in the **Help** panel and displays help for the current command.

Most of the commands include short video clips that show how the command and the options work.

If **Auto-Update** is checked, the help for the current command displays. If **Auto-Update** is unchecked, you can type the name of the command that you want displayed and press **Enter** to display the information.

The **Help** panel gives location of command on the Menus and Toolbars. For example, you can type a command, and the **Help** panel will detail where the commands are found.

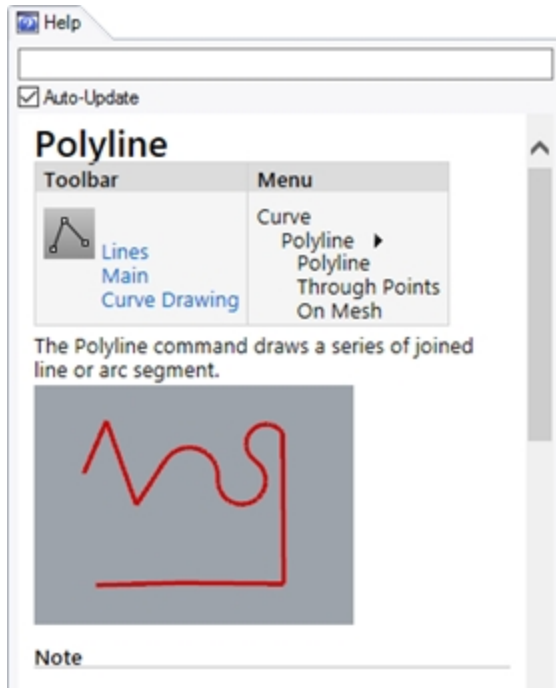

Help panel.

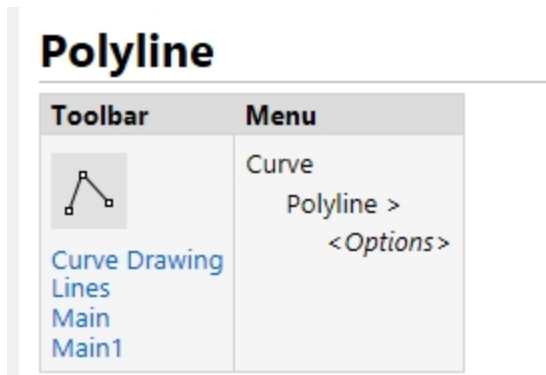

Command Finder

**Note:**

In this training guide, the commands are located for you primarily in the menu.

As you gain experience and prefer to use the toolbars, the **Help** panel will locate the commands for you.

## Command-line history

The **Command History** window lists the last 500 command lines from the current Rhino session.

Press **F2** to view the command history.

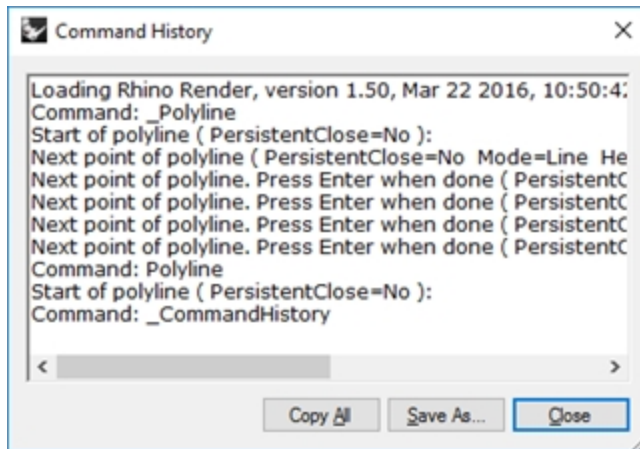

## Mouse actions







### Pick

In a Rhino viewport, the left mouse button  selects objects and picks locations.

In this training guide, *Pick* and *click* are used interchangeably in this guide to communicate a left mouse button pick.

### Three button mouse

The right mouse button  has several functions including panning and zooming, popping up a context-sensitive menu, and acting the same as pressing the **Enter** key.

- Use the left mouse button  to select objects in the model, commands or options on the menus, and buttons in the toolbars.
- Use the right mouse button  to:
  - Complete a command
  - To move between stages of commands
  - To repeat the previous command.
  - To initiate commands from some toolbar buttons.
- Drag with the right mouse button  to pan a parallel view.
- Drag with the right mouse button , hold down **Shift** key to pan a perspective viewport.
- Drag with the right mouse button  to rotate a perspective viewport.
- Use the mouse wheel to zoom and change the magnification of the view
- With a the track pad or 2-button mouse, hold down the **Ctrl** key and drag with the right mouse button  to zoom a viewport.

You must press and hold the right mouse button  down to activate this feature.

**Note:** If you have selected your primary mouse button to be the right mouse button in your operating system's mouse configuration, then use the right as a the Pick.

## Exercise 4-2 Getting started

1. On the **File** menu, click **Open**.
2. In the **Open** dialog box, navigate to the **Level 1** folder and **Open** the model **Start.3dm**.  
This model contains five objects: a cube, a cone, a cylinder, a sphere, and a rectangular plane.  
It opens in a three viewport configuration: it opens in two parallel viewports and one perspective viewport.
3. On the **View** menu, click **Viewport Layout**, and then click **4 Viewports**.  
The result is three parallel viewports and one perspective viewport.  
**Note:** To return to the three viewports, on the **View** menu, click **Viewport Layout**, and then click **3 Viewports**.
4. On the **Status Bar**, click **Grid Snap** to turn on the Grid Snap.  
Grid Snap may already be on in your system. Be careful that you do not turn it off instead of on. If Grid Snap is on, it will be bold and black on the Status Bar. If it is off, the word it will be gray.

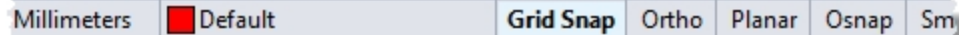

**Note:** This is an important step. Grid Snap only lets your cursor move in certain intervals. In this model, the setting for Grid Snap is one-half of a grid line. Grid Snap helps you line up your objects as if you were building with LEGO® blocks.

### Activate a viewport

1. Click in the **Perspective** viewport to make it active.  
The viewport title highlights when it is active. The active viewport is the viewport where all your commands and actions take place.
2. Click the arrow icon on the **Perspective** viewport title or right-mouse click the viewport title to display the viewport menu, and then click **Shaded**.  
The objects appear shaded. A shaded viewport lets you preview the shapes. The viewport will remain shaded until you change it back to a wireframe view.  
You can change any viewport to the **Shaded** display mode.

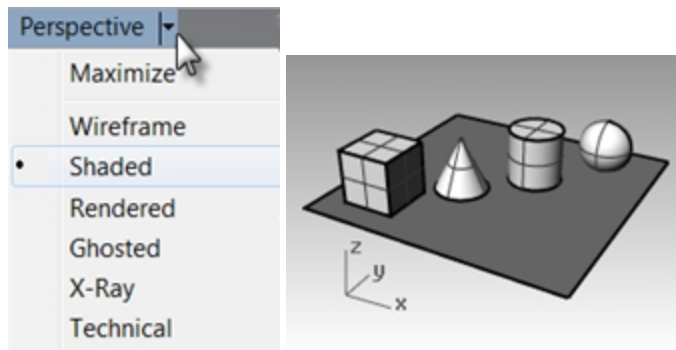

## Render the viewport

1. On the **Render** menu, click **Render**.  
Rendering the model opens a separate render window.

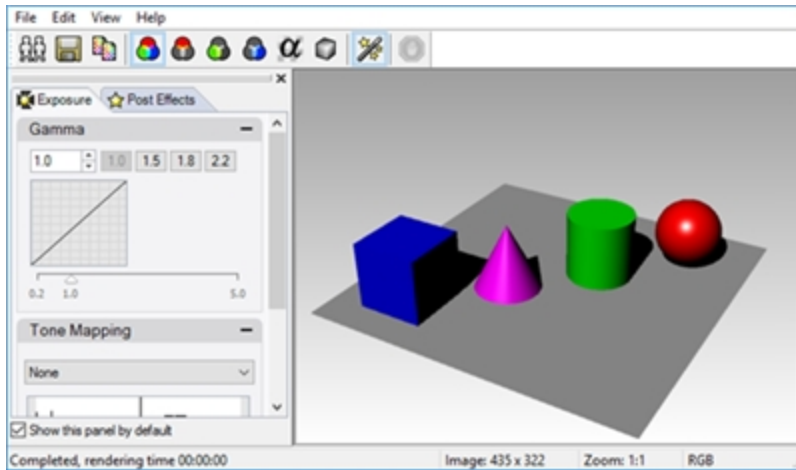

The model displays in render colors previously assigned to the objects. You can also set lights and a background color. You will learn about doing this later.

You cannot manipulate the view in the render display window but you can save image to a file.

2. Close the render window.

## Tumble the viewport

1. In the **Perspective** viewport, click and drag with your right mouse button held down to rotate the view.  
The plane helps you stay oriented.

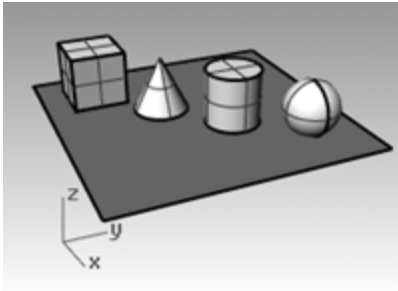

2. On the **Perspective** viewport title menu, click **X-Ray**.

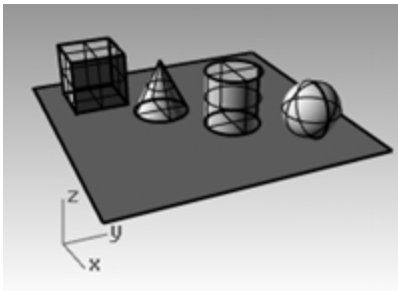



- On the **Perspective** viewport title menu, click **Ghosted**.

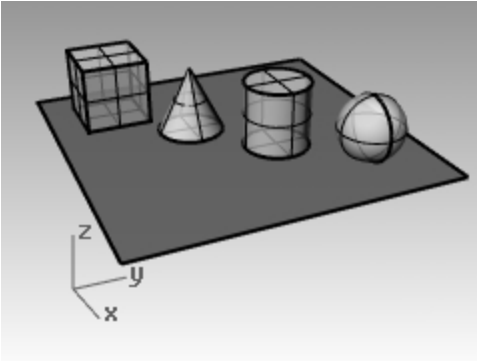

- On the **Perspective** viewport title menu, click **Rendered**.

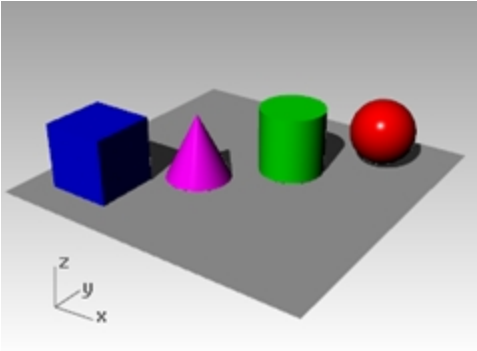

- On the **Perspective** viewport title menu, try **Technical**, **Artistic**, and **Pen** display modes.
- To rotate your view, drag from the bottom of the view toward the top.  
You are now under the objects looking up.

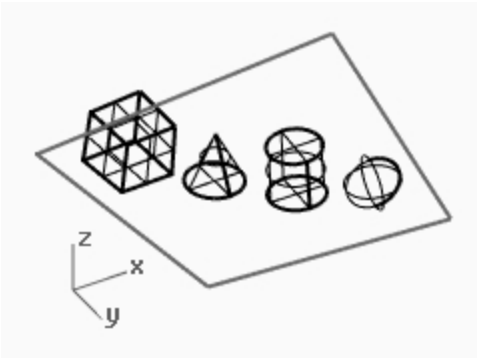

The plane obscures the objects. In the **Shaded** display mode, the plane helps you see when your viewpoint is below the objects.

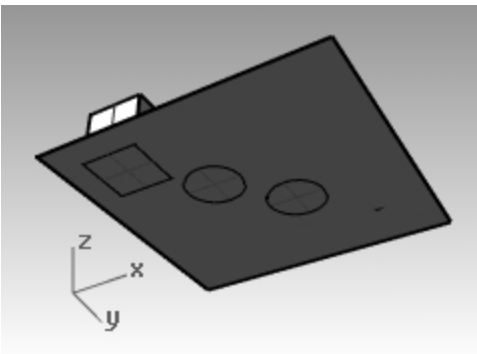

The **Technical** display mode displays lines as though the drawing were a 2-D, flat drawing on paper.

This mode uses real-time silhouettes and intersections, creases, borders, blended shaded and rendered display. Objects behind other objects appear occluded.

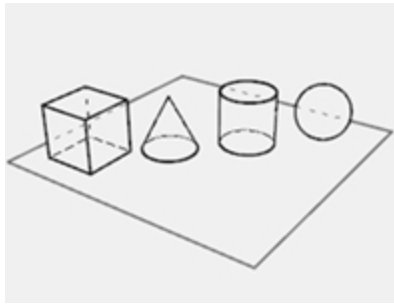

The **Artistic** display mode is similar to **Technical** mode. **Artistic** mode displays lines as though the drawing were a 2-D, flat, pencil drawing on textured paper.

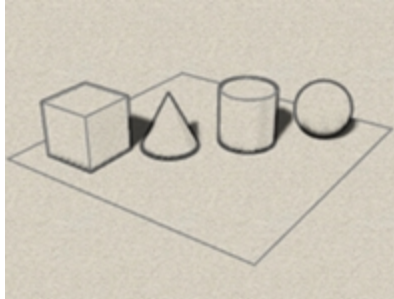

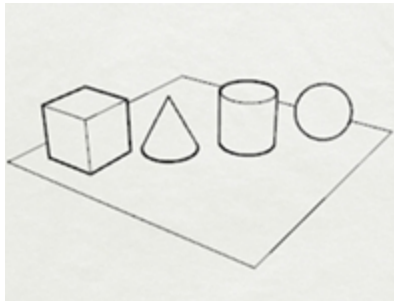

**Pen** display mode is similar to **Technical** mode. **Pen** mode displays lines as though the drawing were a 2-D, flat, pen drawing on paper.



7. Change to **Wireframe** mode.

## Navigating the model

You have used the right mouse button  to rotate in the **Perspective** viewport. You can hold **Shift** and drag with the right mouse button  to pan. Dragging the right mouse button  to move around does not interrupt any commands in progress.

### Pan in a viewport

1. In the **Perspective** viewport, hold the **Shift** and drag with the right mouse button to pan the view.
2. **Pan** the view in the parallel viewports by dragging with the right mouse button. The **Top**, **Front**, and **Right** viewports use a parallel projection. In the parallel viewports, it is not necessary to press the **Shift** key.
3. **Pan** the viewport using the **Shift** key and the right mouse button.

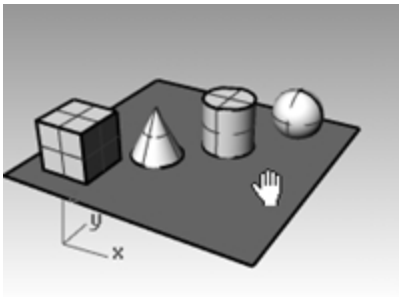

4. **Pan** the viewport in a parallel view with the right mouse button.



### Zoom in and out

Sometimes you want to get closer to your objects or move back so you can see more. This is zooming. As with many things in Rhino, there are several ways to do this. The easiest way is to roll the mouse wheel to zoom in and out. If you do not have a wheel mouse, hold down the **Ctrl** key and drag up and down in a viewport with the right mouse button.

#### Zoom in and out

1. In the **Perspective** viewport, roll the wheel on your mouse forward to zoom in, roll it backward to zoom out. The camera zooms at cursor position.
2. In the **Perspective** viewport, hold the **Ctrl** key, click, hold the right mouse button, and drag the mouse up and down.
3. Drag up to zoom in.
4. Drag down to zoom out.
5. Zoom the viewport using the **Ctrl** key and the right mouse button.

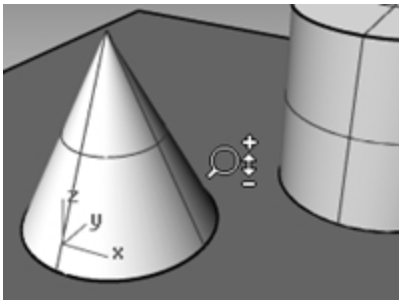

### Zoom extents

The **Zoom** command, **Extents** option displays a viewport so the objects fill up the viewport as much as possible. You can use this command to make everything visible.

#### Zoom extents in a viewport

- ▶ On the **View** menu, click **Zoom**, and then click **Zoom Extents**.  
If you get lost, it is often handy to zoom extents in all your viewports at once, so there is a command to do just that.

#### Zoom extents in all viewports

- ▶ On the **View** menu, click **Zoom**, and then click **Zoom Extents All**.

## Move objects

Dragging follows the construction plane of the current viewport.

### Move objects

1. If **Gumball** is on bold in the **Status Bar**, gumball is on.
2. Click to turn gumball off.
3. Click the cone and drag it.
4. Drag the objects around. You can drag in any viewport.

In this model, the Grid Snap setting is one-half of a grid line. Using this snap, you should be able to line objects up with each other.

The selected cone changes to the selection color.

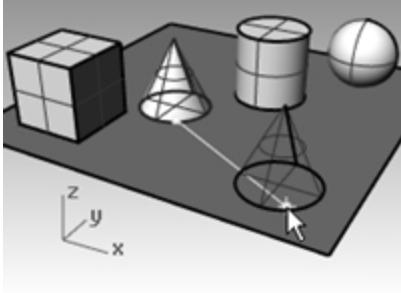

5. Drag the cone in the **Perspective** viewport until it lines up with the cylinder. It will be inside the cylinder.

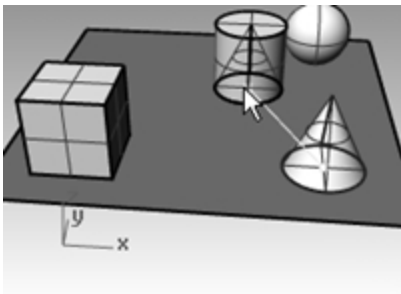

The cone moves on the base represented by the grid. This base is a construction plane. Each viewport has its own construction plane. When you start Rhino, the **Perspective** viewport has the same construction plane as the Top viewport. You will learn more about using construction planes later.

6. From **Edit** menu, click **Undo**.
7. Drag the cone in the **Perspective** viewport until it lines up with the cylinder. Next tap the **Alt** key. You will see a plus + on the screen. Pick a location and the cone is copied to base surface.

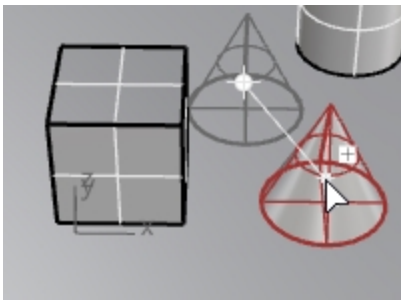

8. From **Edit** menu, click **Undo**.

- In the **Front** viewport, drag a cone to the top of the cylinder.  
Watch what happens in the **Perspective** viewport.  
Watch the other viewports to place your objects.

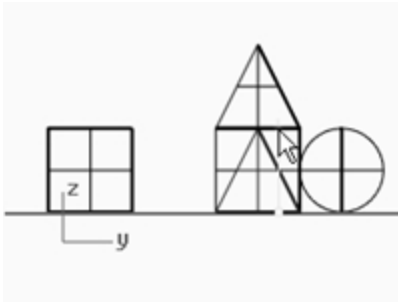

- Click in the **Perspective** viewport.
- Change the viewport to a **Rendered** display.

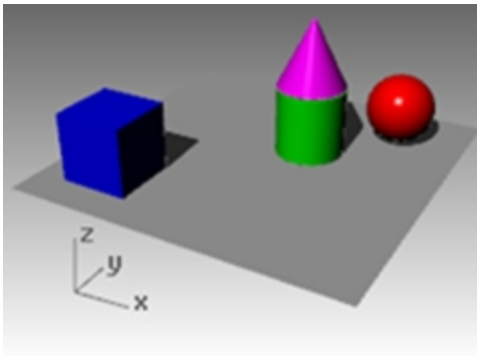

## Copy objects

To create more objects, copy the shapes.

### Open the model

- On the **File** menu, click **Open**.
- Do not save** the changes.
- In the **Open** dialog box, select **Start.3dm**.

### Copy objects

- Click the box to select it.
- On the **Transform** menu, click **Copy**.
- Click somewhere in the **Top** viewport.

It usually helps to click a spot that relates to the object like the middle or near a corner.

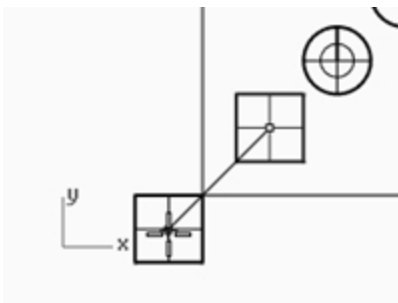

- Click where you want the first copy.  
Zoom in closer if you like.

5. Click other places to make more copies of the box.
6. When you have enough copies, press **Enter**.

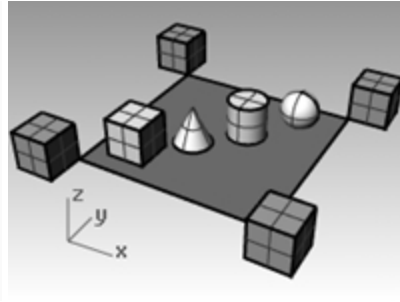
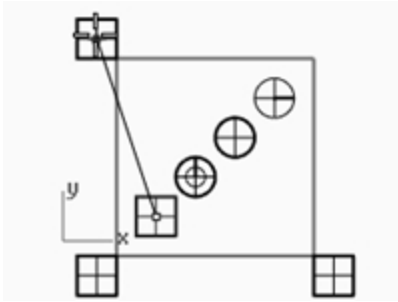

## Editing with gumball

Gumball displays a widget on a selected object, which is used to facilitate the direct editing. The gumball provides move, scale, and rotate transformations around the gumball origin.

- ▶ Click the **Gumball** pane on the Status Bar.

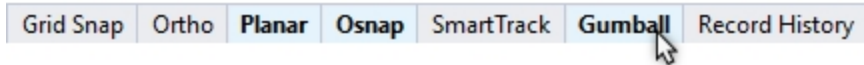

### Gumball actions

- Drag gumball arrows to Move the object.
- Drag scale handles (*squares*) to Scale the object in one direction.
- Drag arcs to rotate the object.
- Tap the **Alt** key after starting to drag to toggle copy mode.
- Click a control handle to enter a numeric value.
- Hold the **Shift** key during Scale to force 3-D scale.

### Gumball Controls

- ① Axis plane indicator
- ② Free move origin
- ③ Menu location

#### Move arrows

- ④ Move X
- ⑤ Move Y
- ⑥ Move Z

#### Rotation arcs

- ⑦ Rotate X
- ⑧ Rotate Y
- ⑨ Rotate Z

#### Scale handles

- ⑩ Scale X
- ⑪ Scale Y
- ⑫ Scale Z
- ⑬ Extrude Z

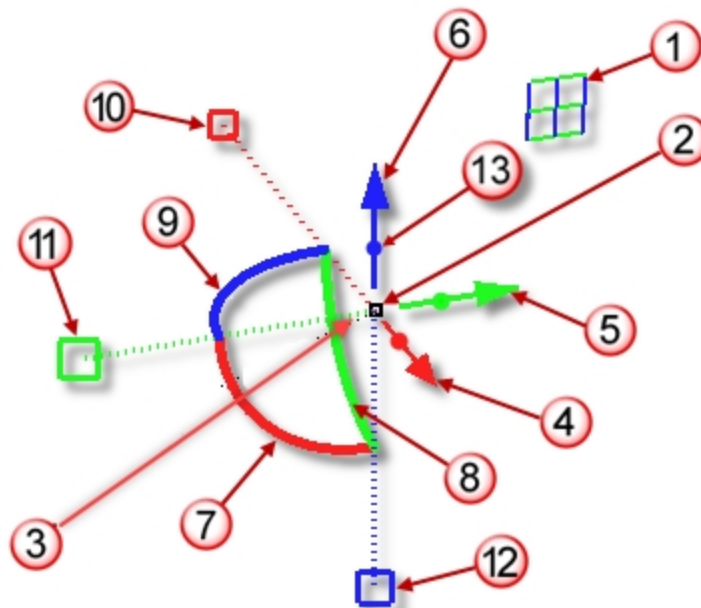

## Move geometry with the gumball

1. In the **Top** viewport, select the cone.
2. Drag the **red arrow** to move the object in the positive x or negative x-direction.

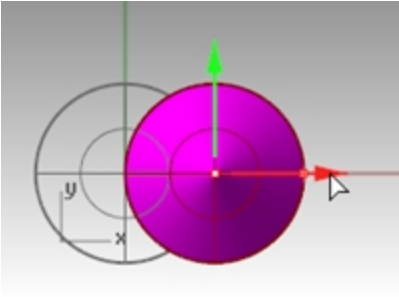

3. Drag the **green arrow** to move the object in the positive y or negative y-direction.

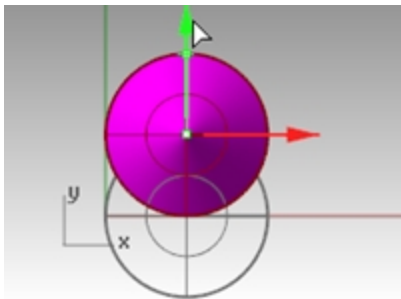

4. In the **Front** viewport, select the cone.
5. Drag the **blue arrow** to move the object in the positive z or negative z-direction.

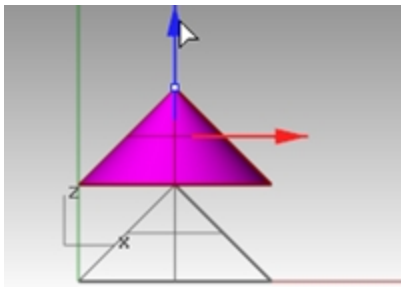

6. **Undo** enough times to get back to the original model.
7. In the **Top** viewport, select the cone.
8. Click **x Move Arrow** (red) to enter numeric value of **1**.

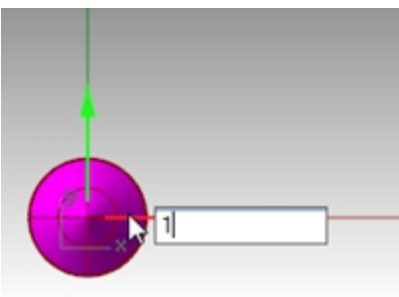



The cone moves a distance of 1 units to the right.

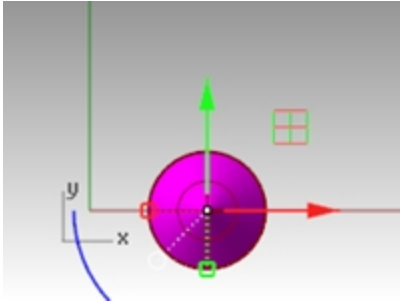

9. Repeat for **y Move Arrow** and **z Move Arrow**.

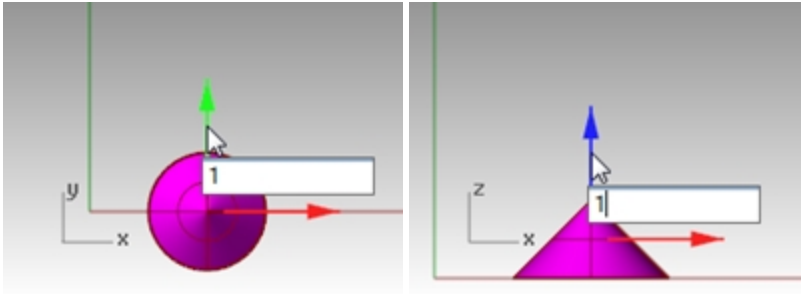

### Copy objects with gumball

In this exercise you will drag objects with the gumball and tap the **Alt** key after starting to drag to toggle copy mode.

1. In the **Top** viewport, select the cone.
2. Drag the **red arrow** to move the object in the positive x or negative x direction.

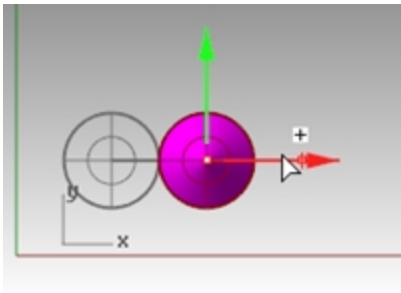

3. While still dragging, tap the **Alt** key.  
A plus + appears to the right of the red arrow.  
When you release the mouse button, a copy of the object is created.

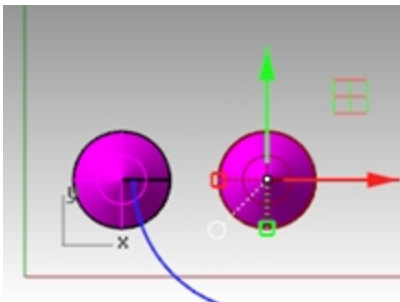

4. In the **Top** viewport, select the two cones.

5. Drag the **green arrow** to move the objects in the positive y direction.

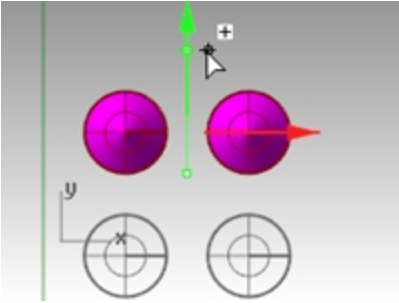

6. While still dragging, tap the **Alt** key.  
A plus appear to the right of the green arrow.  
When you release the mouse button, a copy of the object is created.
7. **Undo** enough times to get back to the original model.

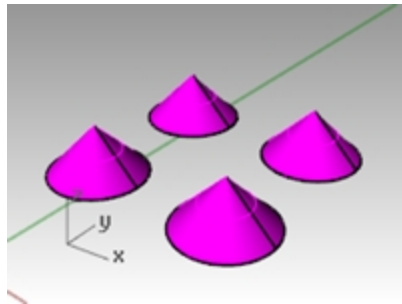

### Rotate objects with gumball

Drag arcs to rotate the object.

1. In the **Top** viewport, select the cone.
2. Click and drag along blue arc to rotate cone.

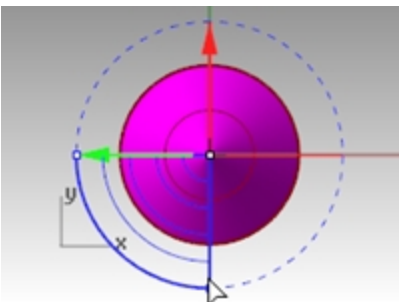

3. In the **Right** viewport, click and drag along green arc to rotate cone.
4. **Undo** enough times to get back to the original model.

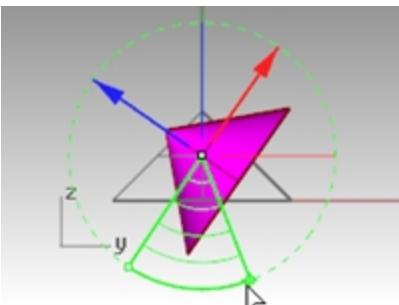

### Scaling with Gumball

- ▶ Drag scale handles (*squares*) to Scale the object in one direction.
- ▶ Click a scale control handles (*squares*) to enter numeric value.
- ▶ Hold the **Shift** key during Scale to force 3-D scale.

## Scale objects with gumball

1. In the **Front** viewport, select the cone.
2. Drag the **red scale handle** (*square*) to scale the object.  
Release the mouse button to complete the scale.

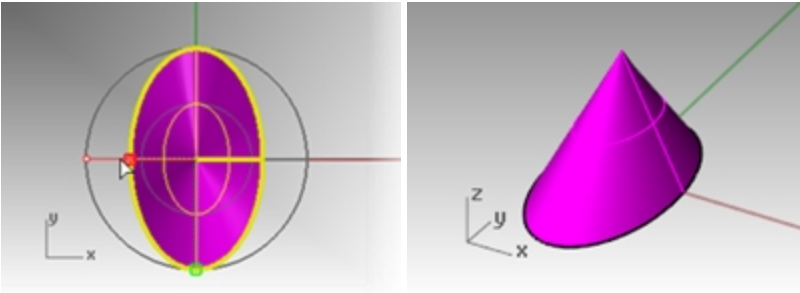

3. In the **Front** viewport, select the cone.
4. Drag the **blue scale handle** (*square*) down to scale the object larger in height.  
Release the mouse button to complete the scale.

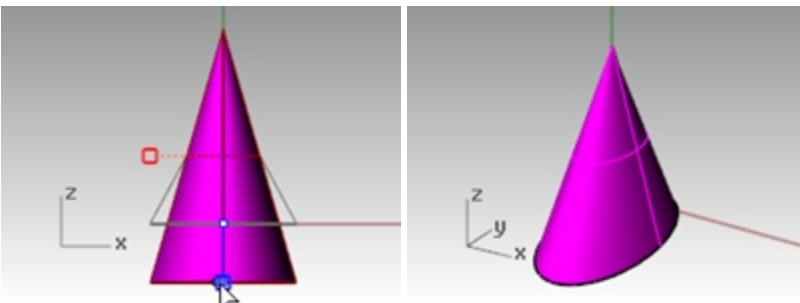

5. Try clicking a **scale control handle** (*square*) and enter numeric value or scale factor like **.75**.

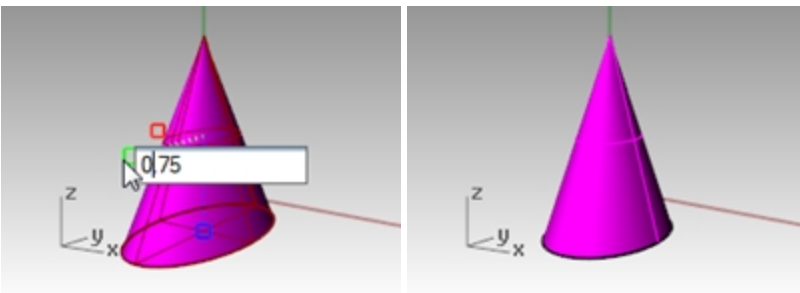

6. In the **Front** viewport, select the cone.
7. While holding down the **Shift** key, drag the red scale handle (*square*) to scale the object uniformly in the x, y, and z direction. Let go to complete the scale.

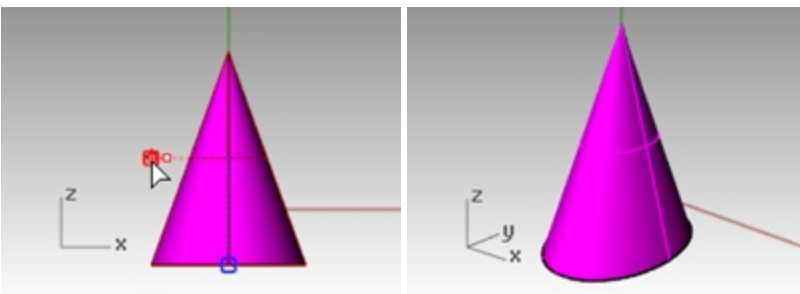

8. **Undo** enough times to get back to the original model.

## Try on your own

- ▶ Make copies of more objects and move them around. See if you can build something.



## Change the view of your model

When you add detail to your models, you will need to see different parts of your model with different magnifications. You can use the view commands, the mouse, and the keyboard to change the view in a viewport.

Each view corresponds to the view through a camera lens. The invisible target of the camera is located in the middle of the viewport.

### Viewports

With Rhino, you can open an unlimited number of viewports. Each viewport has its own projection, view, construction plane, and grid. If a command is active, a viewport becomes active when you move the mouse over it. If a command is not active, you must click in the viewport to activate it.

Most viewport controls can be accessed through the viewport pop-up menu.

To open the pop-up menu, right-click  the viewport title.

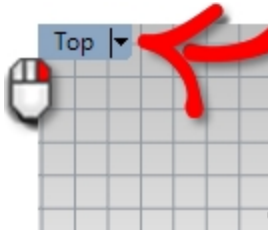

Or click the small triangle on the viewport title.





### Parallel vs. perspective projection

Unlike other modelers, Rhino lets you work in both parallel and perspective views.

#### Toggle between parallel and perspective views

1. Right-click  on the viewport title, and on the menu, click **Viewport Properties**.
2. In the **Viewport Properties** dialog box, for **Projection** click **Parallel** or **Perspective**, and then click .

## Pan and zoom

The simplest way to change the view is to hold down the  key and drag the mouse with right mouse button  held down. This pans the view. To zoom in and out, hold down the  key and drag up and down or use the mouse wheel.

You can also use the keyboard to navigate:

Key	Perspective Projection		Parallel Projection
	Action	Action + 	Action
Left arrow	Rotate left	Pan left	Pan left
Right arrow	Rotate right	Pan right	Pan right
Up arrow	Rotate up	Pan up	Pan up
Down arrow	Rotate down	Pan down	Pan down

Key	Perspective Projection		Parallel Projection
	Action	Action + <b>Ctrl</b>	Action
Page Up	Zoom in		Zoom in
Page Down	Zoom out		Zoom out
Home	Undo view change		Undo view change
End	Redo view change		Redo view change

You can change your view in the middle of a command to see precisely where you want to select an object or select a point.

There are additional zoom controls that will be discussed in other exercises.

## Reset the view

If you get lost, four view techniques can help you get back to a starting place.

### Undo and redo view changes

- ▶ Click in a viewport, press your **Home** or **End** key on your keyboard to undo and redo view changes.

### Set the view looking straight down on the construction plane

- ▶ On the **View** menu, click **Set View**, and then click **Plan**.

### Bring all your objects into view

- ▶ On the **View** menu, click **Zoom**, and then click **Zoom Extents**.

### Bring all your objects into view in all viewports

- ▶ On the **View** menu, click **Zoom**, and then click **Zoom Extents All**.

## Display options

### Exercise 4-3 Practice with Display Options

You will use the camera model to practice changing views. You will create views from six directions and an oblique perspective view.

1. **Open** the model **Camera.3dm**.

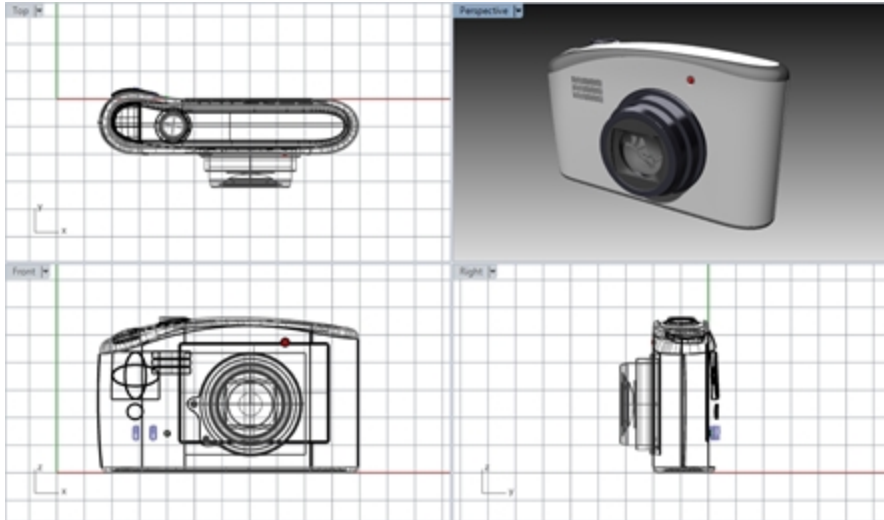

2. Click in the **Top** viewport to make it active.
3. On the **View** menu, click **Viewport Layout**, and then click **Split Horizontal**.
4. Make the **Front** viewport active.
5. On the **View** menu, click **Viewport Layout**, and then click **Split Vertical**.
6. Repeat this step for the **Right** viewport.
7. Right-click  the **Top** viewport title, click **Set View**, and then click **Bottom**.  
Three viewports are split down the middle either horizontally or vertically.

#### Change the shape of viewports

1. Move your cursor to the edge of a viewport until you see the resizing cursor, hold the left mouse button down, and drag the bar.
2. Move your cursor to the corner of a viewport until you see the resizing cursor, hold the left mouse, and drag the intersection in any direction. If several viewports touch at that corner, all re-size.

#### Synchronize the viewports

1. On the **View** menu, click **Zoom**, and then click **Zoom Extents**.
2. On the **Front** viewport title, click **Set Camera**, and then click **Synchronize Views**.  
All the parallel views are sized to the same scale as the active viewport and aligned with each other.
3. Change the viewport displays to one of the shaded viewport settings.

- On the **Front** viewport title on the left viewport, click **Set View**, then click **Left**.
- On the **Right** viewport title on the right viewport, click **Set View**, then click **Back**.

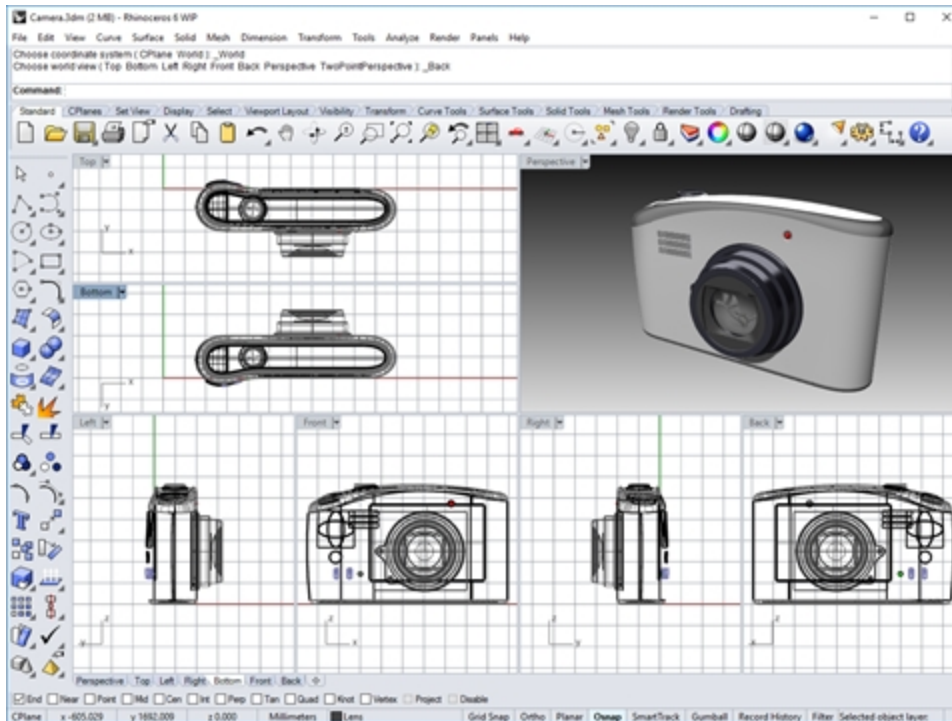

### Zoom to a window

- On the **View** menu, click **Zoom**, and then click **Zoom Window**.
- Click and drag a window around a portion of the model.

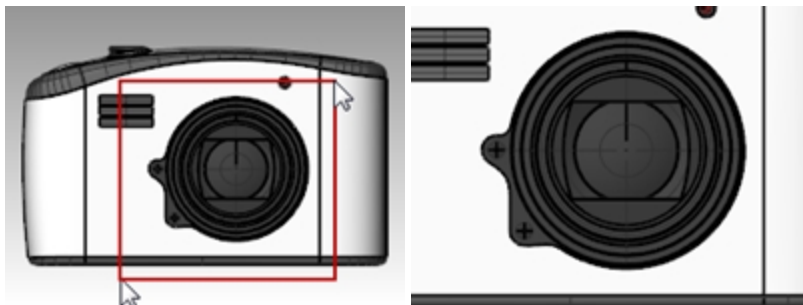

### Zoom to a selected object

- Select the shutter release.
- On the **View** menu, click **Zoom**, and then click **Zoom Selected**.  
The view zooms to the selected object.

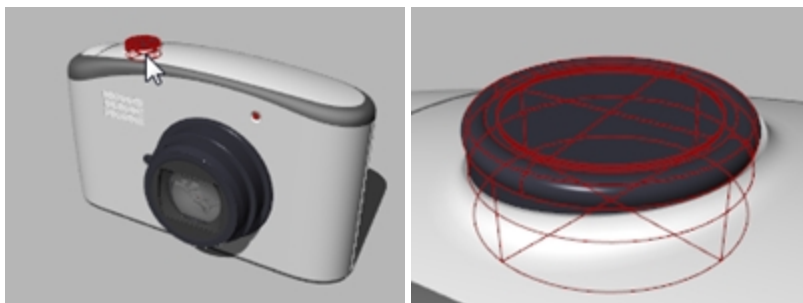

### Rotate the view

- In a perspective viewport, drag with right mouse button.
- In a parallel viewport, on the **View** menu, click **Rotate** or use **Ctrl+Shift** and drag with the right mouse button.

## Maximize and restore a viewport

1. Double-click the viewport title to maximize the viewport.
2. Double-click the title of the maximized viewport to restore the viewport to its smaller size and reveal the other viewports.



## Start drawing

The Line, Lines, and Polyline commands draw straight lines. The **Line** command draws a single line segment. The **Lines** command draws multiple end-to-end line segments. The **Polyline** command draws a series of straight or arc joined segments (a single linear curve with multiple segments). To Rhino, all these lines are *curve geometry*.

## Exercise 4-4 Draw lines

This existing file will help you organize your geometry as you learn about Rhino curves. Create your curves inside the labeled tiles if it helps you match the command to the curve.

**Open** the model **Practice with Lines.3dm**.

Command: Line	Command: Lines	Command: Polyline	Command: Explode 
Command: Line Bothsides	Command: Line FourPoint 	Command: Join 	Command: Curve
ORTHO	GRID SNAP	GRID	Command: InterpCrv

### Draw a single line segment

1. Zoom and pan to the **Command: Line** tile.
2. On the **Curve** menu, click **Line**, and then click **Single Line**.
3. Pick a **Start** point.
4. Pick an **End** point.

The command ends after one segment is drawn.

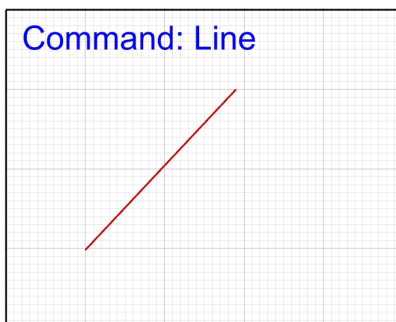

### Draw line segments

1. Zoom and pan to the **Command: Lines** tile.
2. On the **Curve** menu, click **Line**, and then click **Line Segments**.
3. Pick a point in the **Top** viewport.



4. Pick another point in a viewport.  
A line segment appears between the two points.
5. Continue to pick points.  
Additional segments appear.

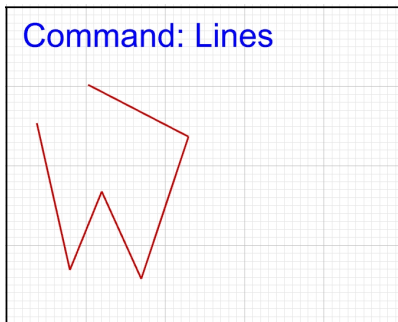

6. Press **Enter** to end the command.  
The segments meet at a common point, but are not joined.

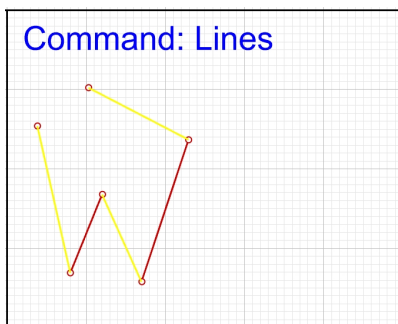

### Close option

The **Close** option closes the shape by drawing a segment from the last point picked to the first point picked. It applies to many curve drawing commands.

#### Use the Close option

1. Repeat the **Lines** command.  
(Choose from the menu again or right-click in the viewport.)
2. Pick a **Start point** and 4 or 5 more points.

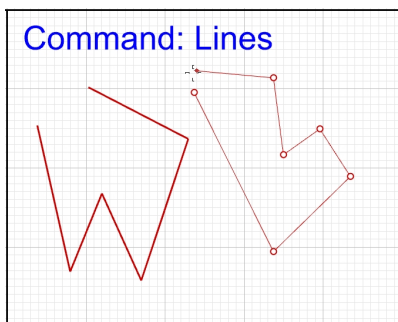

- In the command-line, click **Close**.  
The last line segment will end at the original start.

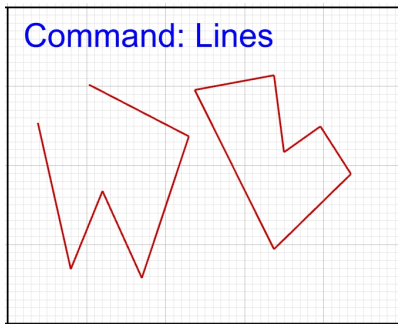

### Draw a polyline

- Zoom and pan to the **Command: Polyline** tile.
- On the **Edit** menu, click **Undo**.  
Or press **Ctrl + Z**.
- Make the layer **Lines 02** current.
- On the **Curve** menu, click **Polyline**, and then click **Polyline**.
- Pick a **Start point** and 3 or 4 more points.
- Press **Enter** when done.

This makes an open polyline. A polyline is a single object made of line segments that are joined together.

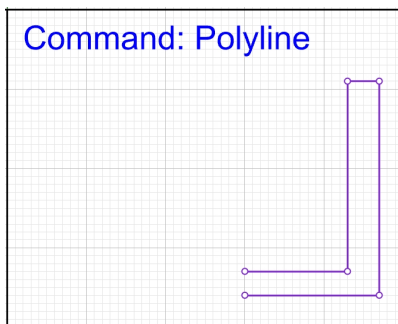

### Use the Undo option

The **Undo** option deletes the last point picked.

### Use the Undo option

- Repeat the **Polyline** command.
- Pick a **Start point** and 3 or 4 more points.
- In the command-line, click **Undo**.  
Notice that your cursor moves back to the previous point and one segment of the polyline is removed.
- Continue to pick points.

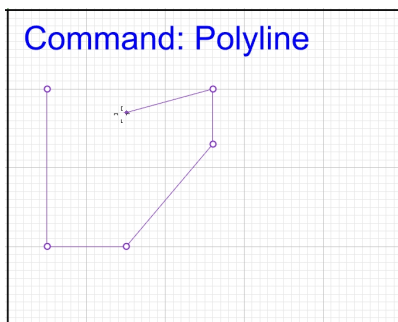

- Click **Close** to end the command.  
This makes a closed polyline (2).

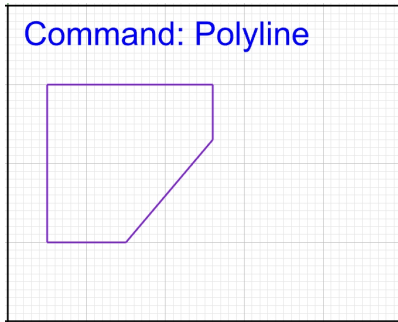

### Use the Line Bothsides option

- Zoom and pan to the **Command: Line Bothsides** tile.
  - On the **Curve** menu, click **Line**, and then click **Single Line**.
  - Click **Bothsides** in the command-line.
  - Pick a point that will locate the middle of the line.
  - Pick an **End** point of the line.
- A segment is drawn with equal length on both sides of the middle point.

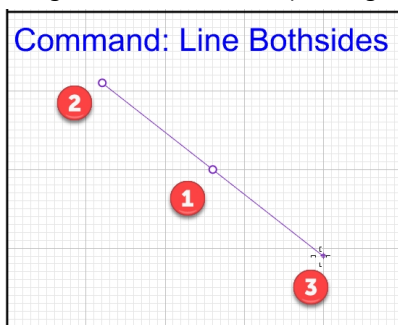

### Use the Line FourPoint Option

- Zoom and pan to the **Command: Line FourPoint** tile.
- On the **Curve** menu, click **Line**, and then click **Single Line**.
- Click **FourPoint** option in the command-line.
- At the **Start of base line**, pick a point (1).
- At the **End of base line**, pick a point (2).

This determines the angle of the line that you are creating.

*Hint: use the Point osnap.*

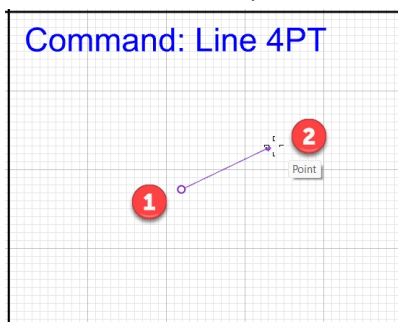

- At the **Start of line**, pick a point (3).

- At the **End of line**, pick a point (4).  
A segment is drawn with input from four points.

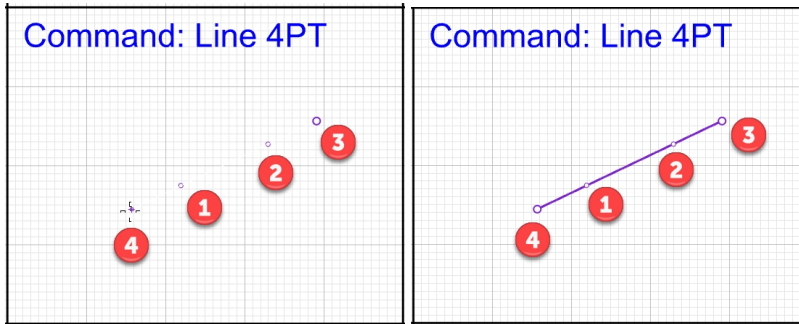

## Free-form curves

### Draw curves from control points

- Zoom and pan to the **Command: Curve** tile.
- On the **Curve** menu, click **Free-form**, and then click **Control Points**.
- Pick a **Start point**.
- Continue picking points.

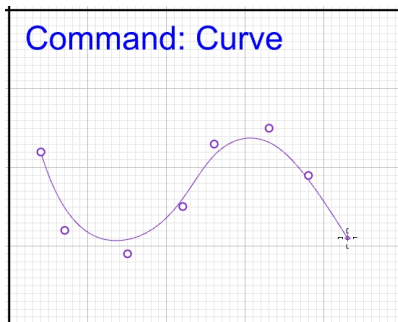

The points that you pick are control points and may not lie on the curve.

- Press **Enter** to end the command.  
This makes an open curve.

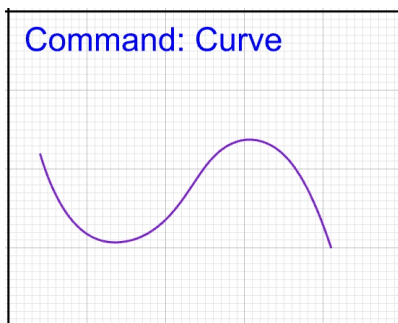

The **InterpCrv** and **Curve** commands draw free-form curves. The **InterpCrv** command draws a curve through the points you pick. The **Curve** command uses control points to create a curve.

### Draw interpolated curves

- Zoom and pan to the **Command: InterpCrv** tile.
- On the **Curve** menu, click **Free-form**, and then click **Interpolate Points**.
- Pick a **Start point**.

- Continue picking points.  
Notice that with this command the curve goes through each point that you pick.

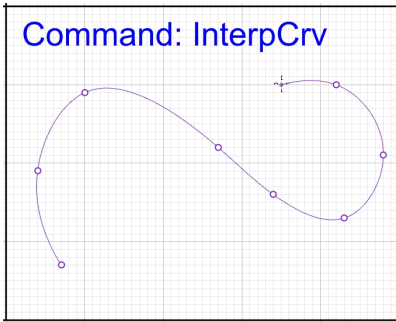

- Press **Enter** to end the command.  
This makes an open curve.

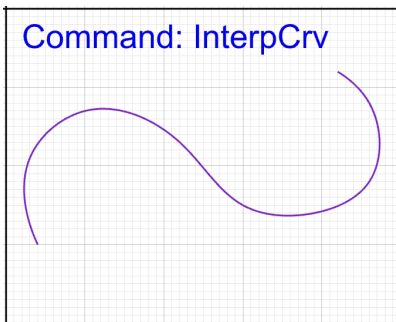

## On your own

Using the Rhino Help, investigate these additional commands. Try them out in the appropriate tile in the existing file.

- Explode** a polyline

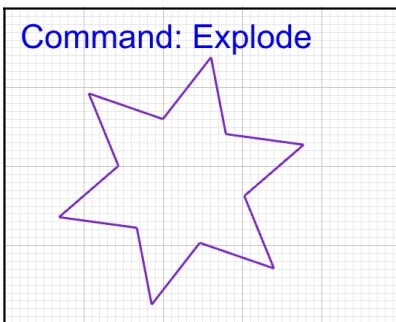

- Join** lines into a polyline.

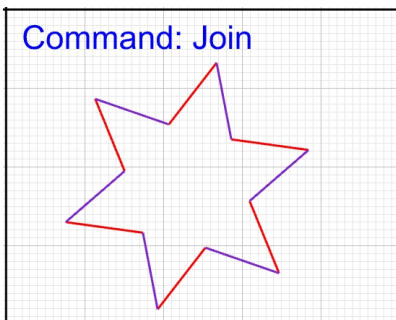

## Save your work

Save your work periodically during a session to keep it from being accidentally deleted.

### Save your model

---

- ▶ On the **File** menu, click **Save**.

Or

Click one of the other options.











You will have an opportunity to save your work.

It is good practice to save your model in stages under different names, using the **Save As** command. This lets you go back to an earlier version of your model for modifications if necessary.

# Chapter 5 - Modeling helpers

Helpers include modeling aids, layers, object selection, hide and show, lock and unlock. In the last chapter, you created a model with lines. If it is not already open, you will need to open it.

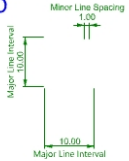
**Open** the model **Practice with Lines.3dm** from your work in the previous chapter.

Command: Line 	Command: Lines 	Command: Polyline 	Command: Explode 
Command: Line Bothsides 	Command: Line FourPoint 	Command: Join 	Command: Curve 
ORTHO	GRID SNAP	GRID 	Command: InterpCrv 

## Modeling aids now

Modeling aids are modes that you can toggle on or off by pressing shortcut keys, a function key, typing a single letter command, or clicking a button.

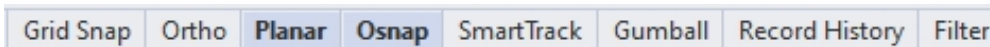

Click the **Grid Snap**, **Ortho**, **Planar**, **Osnap**, **SmartTrack**, **Gumball**, **Record History** and **Filter** panes on the **Status Bar** to toggle these modeling aids on and off.

### Grid Snap

Grid snap constrains the marker to snap to grid intersections.

Press **F9** or type **S** and press **Enter** to toggle Grid Snap on and off.

Press **F7** to hide or show a reference grid in the current viewport at the construction plane.

### Ortho

This modeling aid constrains the marker movement to the points at a specified angle from the last point created. The default angle is 90 degrees.

Press **F8** or press and hold the **Shift** key down to toggle Ortho on and off.

### Gumball

Displays a widget on a selected object or set of selected objects. This widget facilitates move, scale, and rotate transformations around the gumball origin.

*Covered in previous chapter.*

## Modeling aids later

These modeling aids will be covered in a later chapter. Disable them until they are covered. However, here are the basic descriptions to build on later.

## Planar

This is a modeling aid similar to Ortho. This helps you model planar objects by constraining the input to be on a plane parallel to the construction plane that passes through the last point that you picked.

Type **P** and press **Enter** to toggle **Planar** mode on and off.

## Osnap

Object snaps constrain the marker to an exact location on an object such as the end of a line or the center of a circle.

## SmartTrack

This modeling aid uses temporary reference lines and points that are drawn in the Rhino viewport using implicit relationships among various 3-D points, other geometry in space, and the coordinate axes' directions.

*More on this later.*

## Record History

Records history and updates history-aware objects. With the **Record History** and **Update Children** option turned on, geometry created with history can be updated by editing the input curves.

In general, it is best to leave the **Always Record** option unchecked or off and use the **Record History** on in **Status Bar** pane to selectively record history when using commands that support history. For a list of commands that support history, see [History](#) in the Rhino Help.

History can make editing unpredictable when geometry updates automatically and you were not expecting it.

Rhino experts may set history to **Always Record**. However, this is not recommended until you are more experience with Rhino.

## Filter

This modeling aid restricts any selection mode to specified object types. Objects types that can be restricted are: Annotations, Blocks, Control points, Curves, Lights, Meshes, Point clouds, Points, Polysurfaces, Surfaces, Hatches, and others.

## Exercise 5-1 Modeling aids in use

### Draw lines and curves using mode functions

1. Zoom and pan to the **GRID** tile.
2. Turn on the **Dimension** layer.

*Note:* Locking a layer will prevent any accidental edits to objects on this layer.

3. In the Status bar, toggle **Grid Snap** on. Function key **F7** will toggle the Grid visibility. Type the **Grid** and **Enter**.

The marker snaps to each grid intersection. In the current file, **SnapSize** and the **Grid-MinorLineSpacing** are both set to 1.

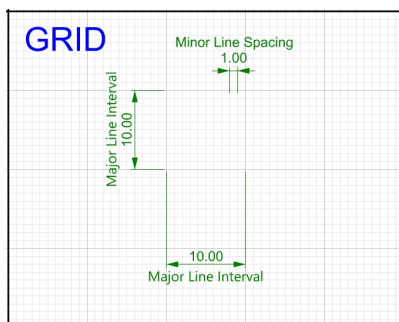

4. Zoom and pan to the **GRID SNAP** tile.



- Toggle **Grid Snap** on and draw some lines.

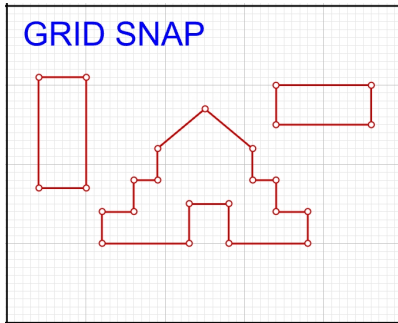

- Zoom and pan to the **ORTHO** tile.
- Toggle **Grid Snap** off, toggle **Ortho** on and draw some lines and curves.  
You can only input points that are at 90 degree intervals from the last point.
- To change the ortho angle, type **OrthoAngle** and **Enter**.
- At the **Ortho Angle** prompt type **45** and **Enter**.  
Now, you can only input points that are at 45 degree intervals from the last point.

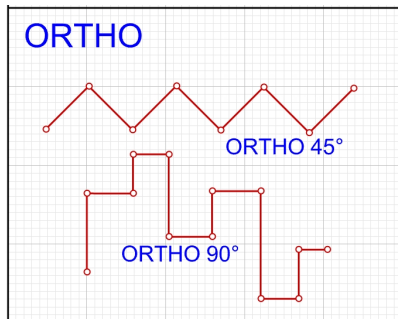

By using **Grid Snap** and **Ortho** toggles, you can draw with precision.  
We will discuss other ways to get precision in a later session.

- Zoom out. The tiles now look complete.

Command: Line 	Command: Lines 	Command: Polyline 	Command: Explode 
Command: Line Bothsides 	Command: Line FourPoint 	Command: Join 	Command: Curve 
ORTHO 	GRID SNAP 	GRID 	Command: InterCrv 

## Summary of Function Keys

Now let's summarize the function keys F1-F12 and the default commands that are assigned to them.  
To review your own settings,, from the **Tools** menu, click **Options** and the **Keyboard** page. Key F4 and F5 are unassigned.

**Hint:** Watch for commands in the training that would be helpful to access using these unassigned keys.

<b>Function Key</b>	<b>Assigned Command</b>
F1	<b>Help</b>
F2	<b>CommandHistory</b>
F3	<b>Properties</b> panel
F4	<i>unassigned</i>
F5	<i>unassigned</i>
F6	<b>Camera</b> Toggle
F7	<b>Grid</b> Toggle
F8	<b>Ortho</b> Toggle
F9	<b>Grid Snap</b> Toggle
F10	<b>PointsOn</b> command
F11	<b>PointsOff</b> command ( <b>Esc</b> also works here.)
F12	<b>DigClick</b> command

## Deleting objects

The **Delete** command and the **Delete** key remove selected objects from the model.

## Selection options

Geometry in Rhino can be selected by picking on an object with the primary mouse button in any of the Rhino viewports.

You can be in a command selecting objects or selecting objects with no command active.

Press the **Shift** key and pick to add to the selection set.

Or press the **Control** key and pick a selected object to remove the highlighting.

You can also select groups of objects using selection windows. They are activated by picking in an area with no geometry and dragging in either the right or left direction for the second pick. The direction of right or left will determine how objects are selected.

A **crossing** window will select objects that are crossed by the windows or enclosed by the window.

To use a crossing window, pick in an open area on the screen, and then drag the window from **right to left**.

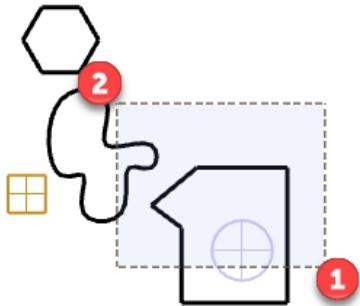

*Crossing selection window*

An **enclosed** window will only select objects that are completely surrounded by or enclosed by the window. To use an enclosed window, pick in an open area on the screen, and then drag the window from **left to right**.

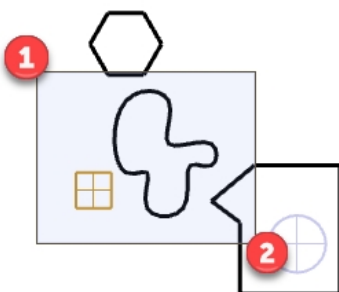

*Enclosed selection window*

## Exercise 5-2 Practice using selection options

1. Open the model **Delete.3dm**.

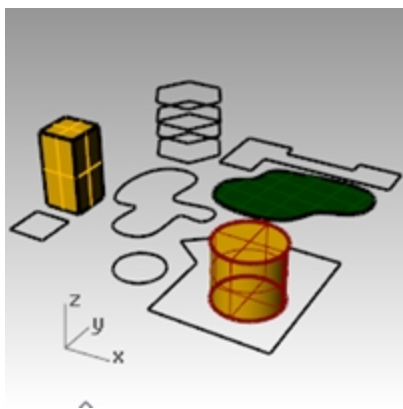

2. Select the square and the circle.
3. On the **Edit** menu, click **Delete** or press the **Delete** key. The objects disappear.

## Select objects for deletion

1. In the **Top** viewport, select one of the lines on the hexagon.  
Because there are several curves superimposed on each other, the pop-up **Selection Menu** appears, allowing you to select only one of the curves.
2. Select the top curve from the list.

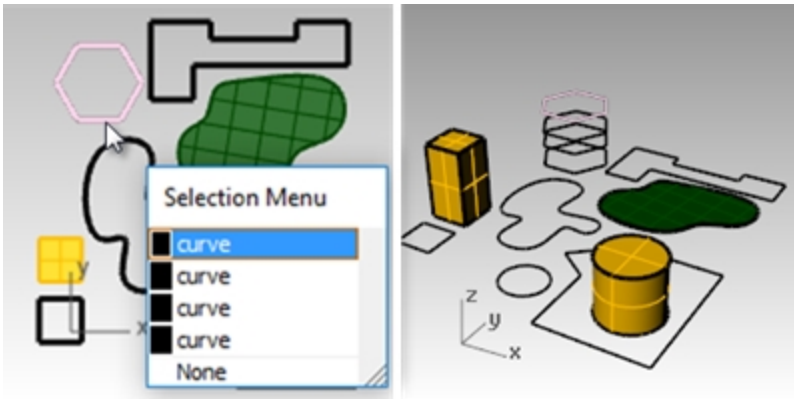

3. On the **Edit** menu, click **Delete**.  
In the **Perspective** viewport, observe one disappear.
4. In the **Top** viewport, use a crossing window to select the surface and the polyline in the top right part of the drawing.  
To use a crossing window, pick in an open area on the screen, and then drag the window from right to left. Both objects are selected.

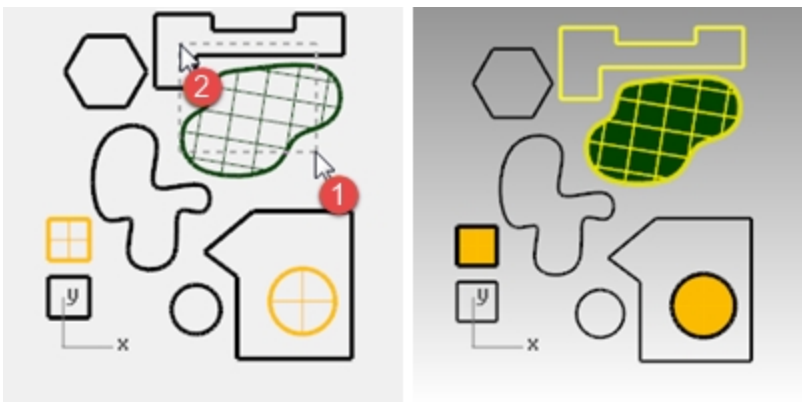

5. On the **Edit** menu, click **Delete**.
6. Window select the polyline and the cylinder in the lower right part of the drawing.  
Only those objects that are completely inside the window are selected.
7. Hold down the **Ctrl** key, and click the cylinder to remove it from the selection set.

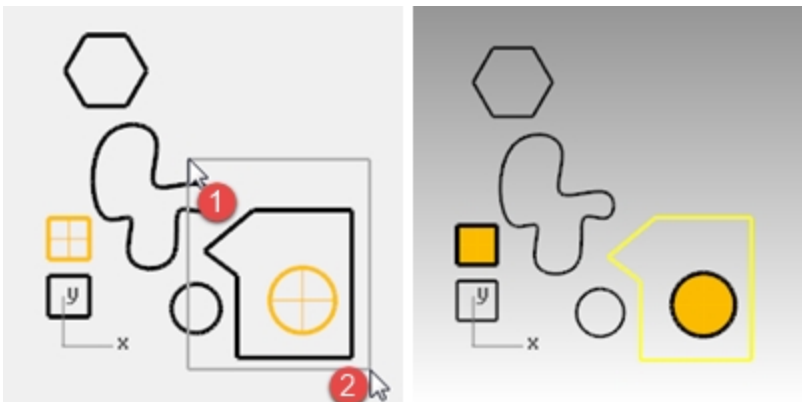

8. On the **Edit** menu, click **Delete**.
9. Continue deleting objects in the drawing.

- ▶ Practice using different selection methods to select and deselect objects. Use crossing and window selection.
- ▶ Hold the **Shift** key while selecting to add objects to your selection set.
- ▶ Hold the **Ctrl** key while selecting to remove objects from your selection set.

### Undo and redo deletions

1. On the **Edit** menu, click **Undo**.  
Each time you click, Undo takes you back one command.
2. On the **Edit** menu, click **Redo**.  
Each time you click, the previous Undo is reinstated.
3. **Undo** all the deletions you made in the previous exercise.

### Dedicated selection commands

In addition to the selection options we just practiced, there are several other useful tools for selecting objects. In the next exercise we will use some of these tools.

### Select objects using select tools

1. On the **Edit** menu, click **Select Objects**, and then click **Curves**.  
All the curves are selected.
2. On the **Edit** menu, click **Select Objects**, and then click **Invert**.  
Everything but the previously selected curves is selected.
3. On the **Edit** menu, click **Select Objects**, and then click **None**.  
Everything is unselected.
4. On the **Edit** menu, click **Select Objects**, and then click **Polylines**.  
All of the polylines are selected.
5. On the **Edit** menu, click **Select Objects**, and then click **Surfaces**.  
The single surface is added to the selection set.
6. On the **Edit** menu, click **Select Objects**, and then click **Polysurfaces**.  
The polysurfaces are added to the selection set.
7. On the **Edit** menu, click **Select Objects**, and then click **None**.
8. Draw a few lines and curves.
9. On the **Edit** menu, click **Select Objects**, and then click **Last Created Objects**.  
The last object you created is selected.

### Filter selection

A filter restricts any selection mode to specified object types. Objects types that can be restricted are: Annotations, Blocks, Control points, Curves, Lights, Meshes, Point clouds, Points, Polysurfaces, Surfaces, Hatches, and Others.

*Note:* Filters are only in affect when the Filter dialog is open. Closing the dialog, disables the active filter.

### Use the Filter control

1. On the **Status Bar**, click **Filter**.  
The selection **Selection Filter** control will appear.

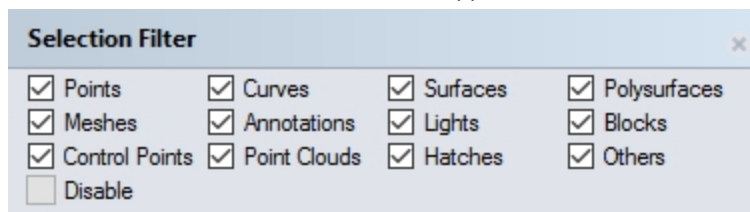

2. Right-click  **Curves**.  
All other selection options are unchecked.

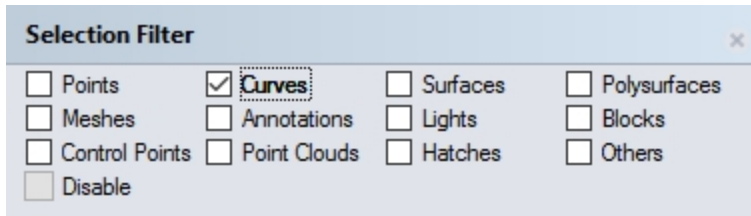

3. Use a crossing selection or **Ctrl** + **A** keys to select the entire the drawing.  
Only the curves are selected.
4. Press **Esc** to deselect.

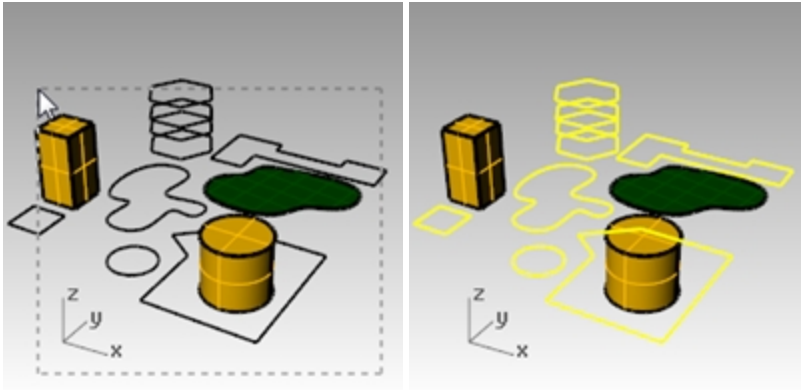

5. Right-click  **Surfaces**.  
All other selection options are unchecked.
6. Use a crossing window or **Ctrl** + **A** to select the entire the drawing.  
Only the surfaces are selected.
7. Press **Esc** to deselect.

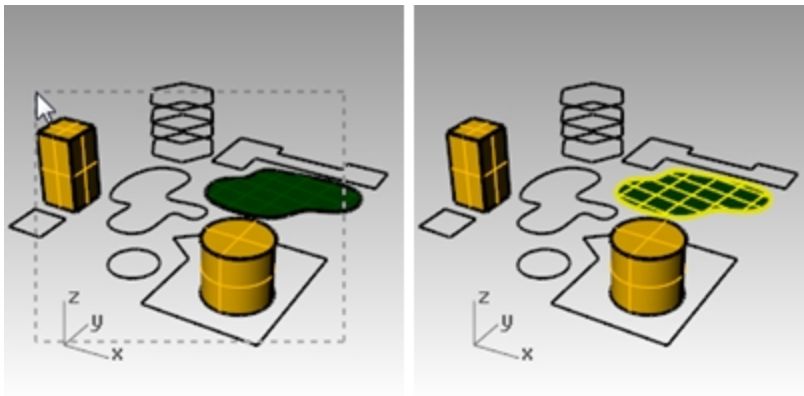

8. Right-click  **Polysurfaces**.  
All other selection options are unchecked.
9. Use a crossing window or **Ctrl** + **A** to select the entire the drawing.  
Only the polysurface objects are selected.

10. Press **Esc** to deselect.

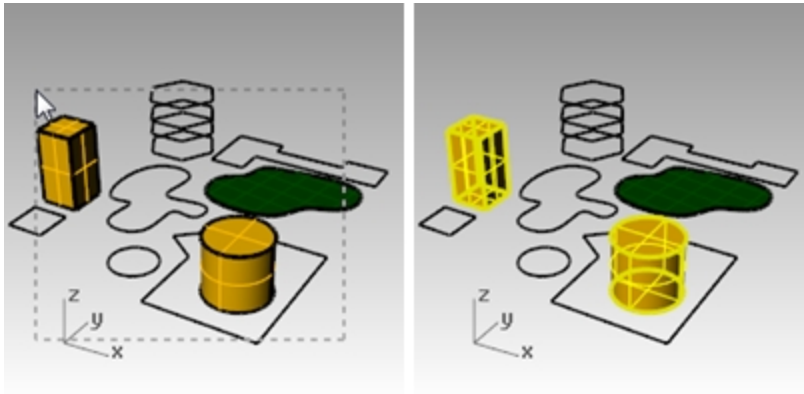

11. Right-click  **Disable** to reset all filters to on.

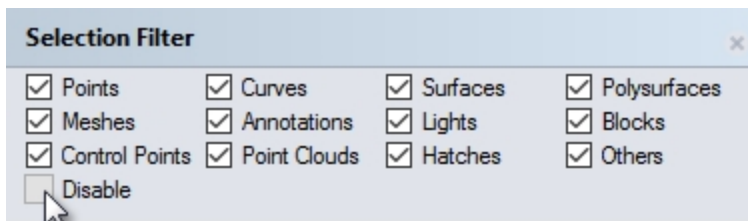

## Object visibility and locking

A few commands are useful here before we go on.

### Select a single object

- ▶ Move your pointer arrow over the object and click.  
The object turns yellow, which is the default selection color.

### Select more than one object

1. Move your pointer arrow over the first object and click.
2. While holding the **Shift** key down, move your pointer over another object and click.

### Hide an object

1. Select an object.
2. On the **Edit** menu, click **Visibility**, and then click **Hide**.  
The object becomes invisible.

### Show hidden objects

- ▶ On the **Edit** menu, click **Visibility**, and then click **Show**.  
The **Show** command re-displays all hidden objects.

### Lock an object

1. Select an object.
2. On the **Edit** menu, click **Visibility**, and then click **Lock**.  
The object becomes shaded gray. You can see the locked object, you can snap to it, but you cannot select it.

### Unlock locked objects

- ▶ On the **Edit** menu, click **Visibility**, and then click **Unlock**.  
The **Unlock** command unlocks all locked objects.

## Layers

Rhino layers work like other CAD layering systems you may be familiar with. By creating objects on different layers, you can edit and view related portions of a model separately or as a composite. You can create as many layers as you like.

You can display all layers simultaneously or turn any of them off. You can lock layers so they are displayed but cannot be selected. Each layer has a color. You can assign a name to each layer (for example, Base, Body, Top) to organize the model or you can use preset layer names (Default, Layer 01, Layer 02, Layer 03).

The **Layers** panel manages layers. Use it to set up layers for your model. The **Layers** panel can be floating or docked with the other tabbed panels like **Properties**, **Command Help**, **Lights**, **Notes**, and more.

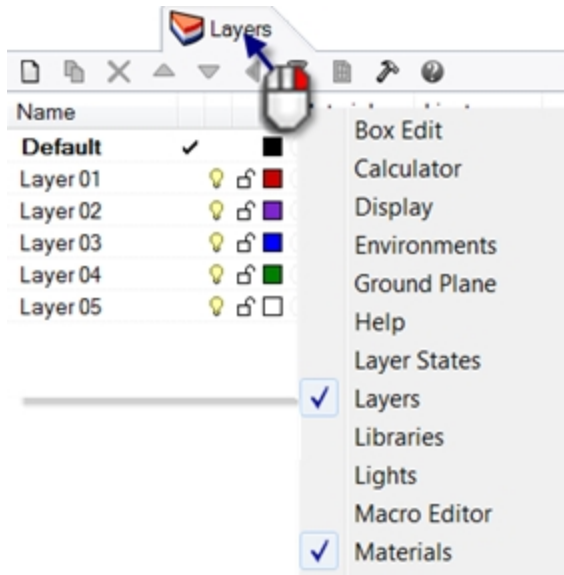

## Exercise 5-3 Working with layers

### Create a new layer

1. On the **Edit** menu, click **Layers**, and then click **Edit Layers**.
2. In the **Layers** panel, click the **New icon**.

The **Default** layer is created automatically when you start a new model with no template. If you use a standard Rhino template, a few additional layers are also created.

3. The new layer, **Layer 06**, appears in the list. Type **Lines** and press **Tab**.  
Use the **Tab** key to quickly add layers.
4. The new layer, **Layer 06**, appears again. Type **Curves** and press **Tab**.
5. The new layer, **Layer 06**, appears. Type **Solids** and press **Enter**.

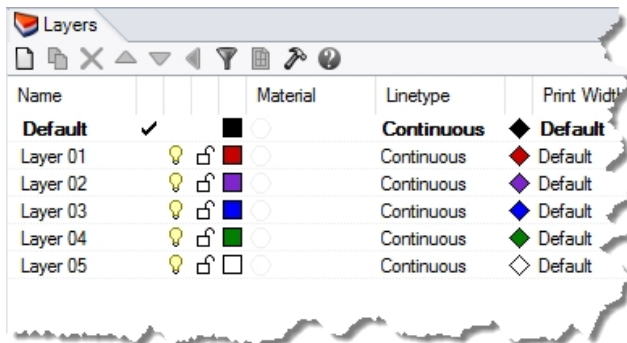





- Draw more lines and curves on each layer.  
Clicking the name or the check box sets the current layer.

**Note:** If objects are selected, and a layer is selected from the Status Bar, the highlighted objects will be changed to the selected layer and the current layer does not change.

### Lock a layer

- On the **Status Bar**, click the **Layer** pane, click **Solids** to make the **Solids** layer current.
- On the **Layer** pop-up menu, click the **Lock** icon on the row for the **Lines** layer.  
Locking a layer turns it into a reference only layer. You can see and snap to objects on locked layers. You cannot select any objects on locked layers. You cannot make a locked layer current without unlocking it.

### Turn a layer off

- On the **Status Bar**, click the **Layer** pane.
- On the **Layer** pop-up menu, click the **On/Off** icon (light bulb) in the row for the **Curves** layer.  
Turning a layer off makes all objects on it invisible.

### Change an object from one layer to another

- Select an object.
- On the **Edit** menu, click **Layers**, and then click **Change Object Layer**.
- In the **Layer for object** dialog box, select the new layer for the object, and click **Ok**.

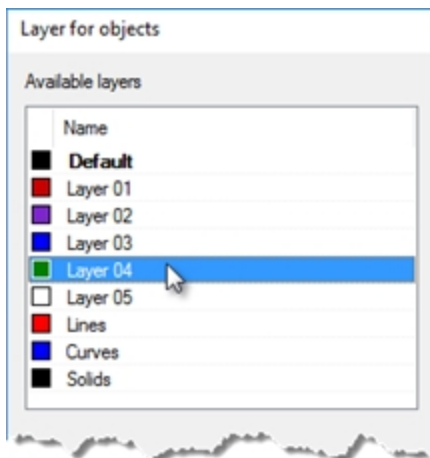

- From the **Edit** menu, click **Undo**.
- Select an object.
- In the **Properties** panel, in the **Object** section in the **Layer** row, click arrow and from the menu select the new layer for the object.

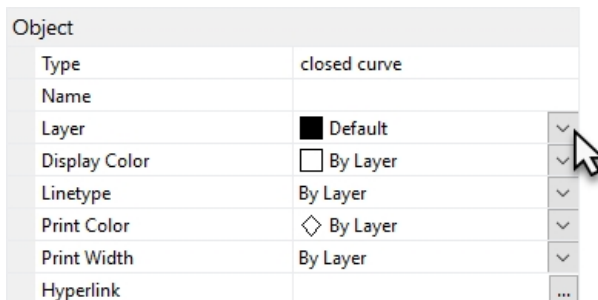

- From the list, pick the new layer.

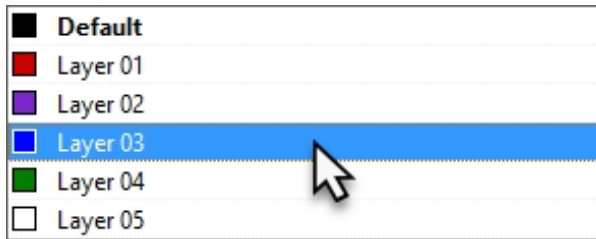

- Click on the Rhino viewport to un-select the object and see the change.  
*Hint:* The object will display the layer color, if the object's **Display Color** is set to **By Layer** in the **Properties** panel.

## Exercise 5-4 Practice with Layers

You will look at an existing model that uses hierarchical layers.

- Open the model **Camera.3dm**.

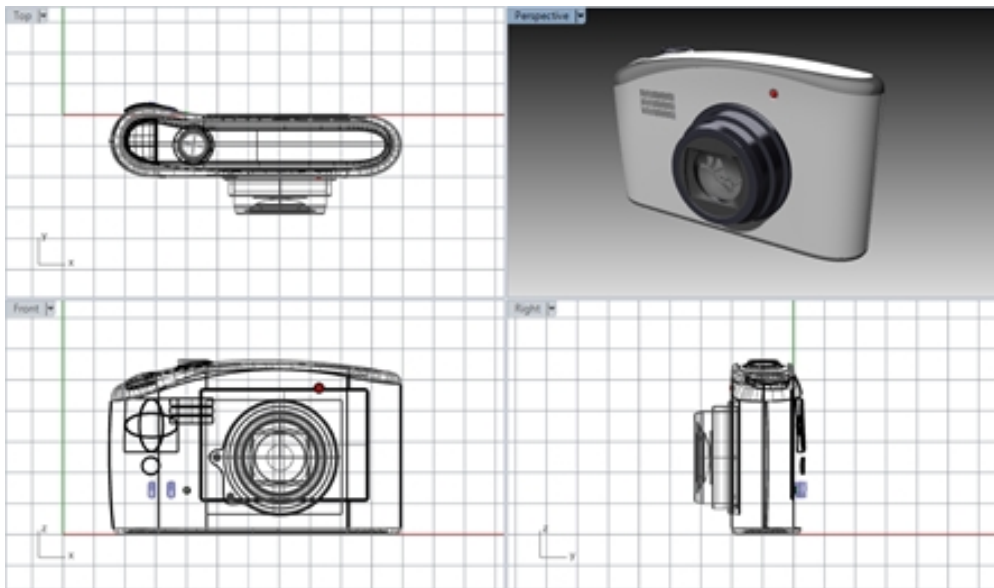

- Go to the **Layer** panel. Lens is the current layer.

Name	Current	On	Lock	Color	Material	Linetype
▼ Lens	✓			■	● Lens	Continuous
Trim and Details		💡	🔒	■	● Trim	Continuous
▼ Body		💡	🔒	■	○ White Plastic	Continuous
▼ Trim and Details		💡	🔒	■	● Trim	Continuous
Flash switch		💡	🔒	■	○	Continuous
Bumper		💡	🔒	■	● Rubber	Continuous
Screen		💡	🔒	■	○	Continuous

- Turn *off* the **Bumper** layer. The bumper goes off, but the parent layer is still visible.
- Turn *on* the **Bumper** layer
- Turn *off* the **Body** layer. All children layers to the **Body** layer, also are turned *off*.

- Under the **Lens** layer, highlight the **Trim and Details** layer and use **arrow buttons** across the top to move the layer out of the hierarchy.

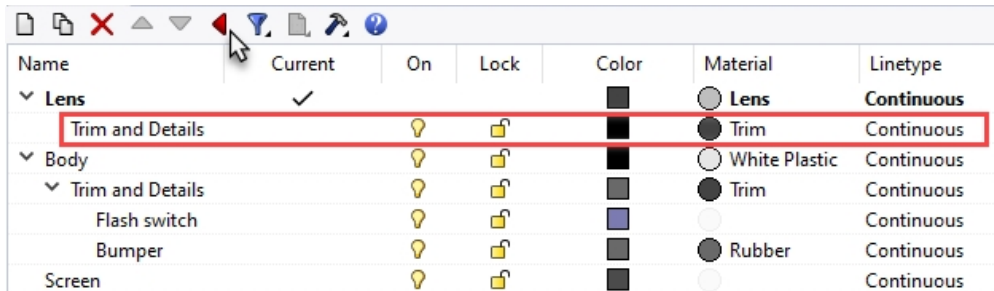

- Highlight the **Trim and Details** layer and drag and drop back under the **Lens** layer. It will now be returned to the former hierarchy.
- Close** the **Camera** model and do not save.

**Extra Credit:**

- Discuss with your class how hierarchical layers can be used to organize models from many different industries.
- Brainstorm how hierarchical layers could be used in an architectural model.
- Develop standard set of layers for your templates that uses the hierarchical layer organization.

# Chapter 6 - Precision modeling

---

So far you have been drawing imprecise lines. Now you will try drawing lines at specific places. To do this you will use coordinates. Whenever you draw a curve, or create a solid primitive, Rhino asks you for a series of points.

You can tell that Rhino is asking for point input two ways: the command prompt has a prompt like **Start of line**, **Start of polyline**, **Start of curve**, or **Next point** and the arrow-shaped cursor turns into a cross-shaped cursor.



You can enter a point two ways:

**Pick** a point in a viewport with the left mouse button .

**Type** coordinates at the command-line. (Enter is necessary after you type in a coordinate at a point prompt.)

Note: Give these terms special attention in the following section on Coordinate input. It will be critical that you **Pick** or **Enter** as indicated in the specific steps.

If you have selected your primary mouse button to be the right mouse button  in your operating system's mouse configuration, then use the right as a the **Pick**.

You will select the units and tolerance of the model before you begin. You can do this in the **Options** dialog under the **Units** page or by picking a template that has units and Tolerance already set.

You can change the tolerance after you start, but objects that are edited before the change still have the old tolerance value.

## Coordinate entry

Rhino uses a fixed Cartesian coordinate system called the world coordinate system (WCS), based on three axes (the x-, y-, and z-axes) that define locations in three-dimensional space.

Each viewport has a construction plane that defines coordinates for that viewport. We will work in the Top and Perspective viewports where the two coordinate systems are the same.

## Exercise 6-1 Set up a model

---

1. On the **File** menu, click **New**.
2. Click **Small Object - Millimeters.3dm**, and then click **Open**.
3. On the **File** menu, click **Save As**.
4. Name the model **BOXES**.  
Use the **BOXES.3dm** model to learn how to draw with absolute coordinates.

## Absolute coordinates

The first forms of coordinates you will use are called absolute coordinates. Absolute coordinates are exact locations relative to the x-, y-, and z-axes.

### Enter absolute coordinates

---

1. In the **Top** viewport, double-click the viewport title to maximize the viewport.
2. On the **Curve** menu, click **Polyline**, and then click **Polyline**.
3. To **Start** type **0** and press **Enter**.  
If you are going to start at the origin of the sheet (0,0,0) you can simply type **0** as a shortcut.
4. For the **Next point** type **5,0** and press **Enter**.
5. For the **Next point** type **5,5** and press **Enter**.

6. For the **Next point** type **0,5** and press **Enter**.
7. Click **Close** to close the polyline.

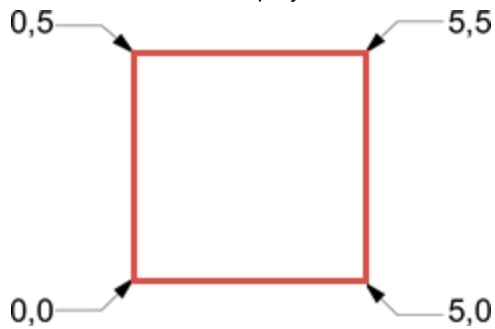

### Relative coordinates

Relative coordinates are often easier than absolute coordinates to use.

Every time you select a point, Rhino saves that point as the last point.

Relative coordinates are based on the last point entered, instead of on the origin (0,0,0) of the construction plane.

Precede the x,y,z coordinates with the letter **R** (upper or lower case) or the **@** symbol to enter relative coordinates.

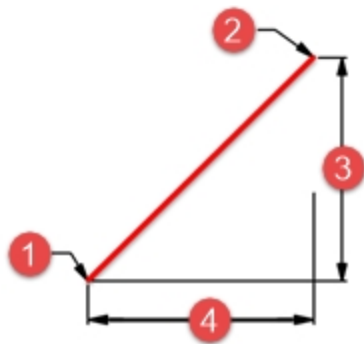

(1) Last point, (2) Next point, (3) Change in y, (4) Change in x.

### Enter relative coordinates

1. On the **Curve** menu, click **Polyline**, and then click **Polyline**.
2. For the **Start point**, type **8,0** and press **Enter**.  
These are absolute coordinates.
3. For the **Next point**, type **r5,5** and press **Enter**.  
These are relative coordinates.
4. For the **Next point**, type **r-5,0** and press **Enter**.
5. Click **Close** to close the polyline.

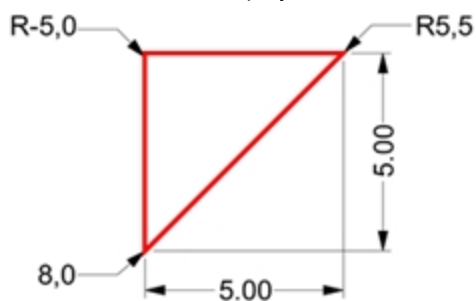

### Polar coordinates

Polar coordinates specify a point that is a distance and direction away from 0,0 in the current construction plane.

Vector directions in Rhino start with zero degrees at 3 o'clock on a standard clock. They change in an anti (counter)-clockwise direction as illustrated below.

For example, if you want a point four units away from the construction plane origin, at a 45° angle counterclockwise from the construction plane x-axis, type **4<45**, and press **Enter**.

Relative polar coordinates are preceded by **R** or **@**; absolute polar coordinates are not.

Instead of using x, y, and z coordinates, enter relative polar coordinates like this: **Rdistance<angle**.

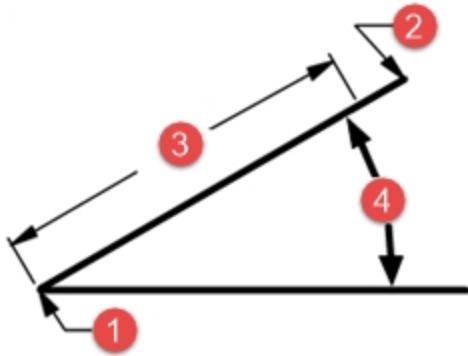

(1) Last point, (2) Next point, (3) Distance, (4) Angle.

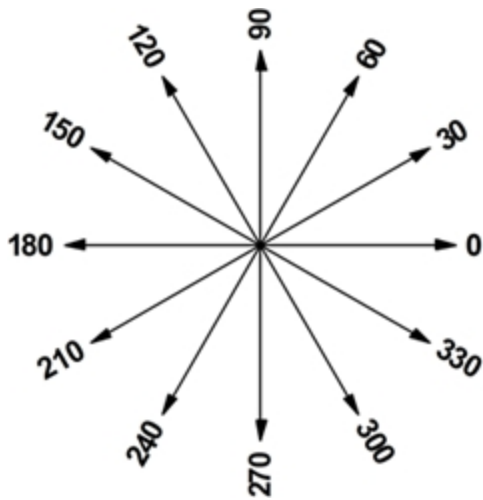

### Enter polar coordinates

1. On the **Curve** menu, click **Polyline**, and then click **Polyline**.
2. For the **Start point**, type **0,8**, and press **Enter**.
3. For the **Next point** type **R5<0**, and press **Enter**.
4. For the **Next point** type **R5<90**, and press **Enter**.
5. For the **Next point** type **R5<180**, and press **Enter**.
6. Click **Close** to close the polyline.

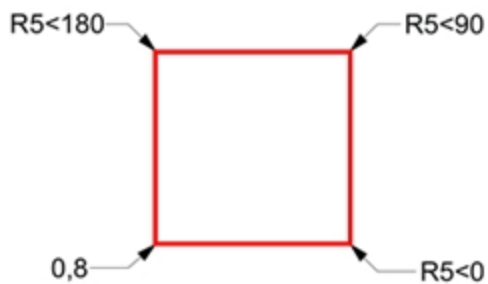

## Distance and angle constraint entry

Using distance constraint entry, type a distance and press **Enter** to specify a point. Then as you move your cursor in any direction, the distance from the last point will be constrained. This is a good way to quickly specify a line length. Using angle constraint entry, type < followed by a value and press **Enter** specify an angle. The next point is constrained to lines at multiples of the angle relative to the x-axis you specified.

### Use the Shift key to toggle Ortho

- ▶ When **Ortho** is off, hold the **Shift** key down to toggle it on while you pick points. This method is an efficient way to draw perpendicular lines. In the following example, draw a line five units long using distance constraints.

### Distance constraint entry

1. On the **Curve** menu, click **Polyline**, and then click **Polyline**.
2. For the **Start** point, type **8,8**, and press **Enter**.
3. For the **Next point**, type **5**, and press **Enter**.
4. Hold the **Shift** key down, and pick a point to the right. **Shift** toggles **Ortho** mode to constrain the marker to 0 degrees.
5. For the **Next point**, type **5**, and press **Enter**.
6. Hold the **Shift** key down, and pick a point **above** the last point. The **Shift** key toggles **Ortho** mode to constrain the cursor to 90 degrees.
7. For the **Next point**, type **5**, and press **Enter**.
8. Hold the **Shift** key down and pick a point to the **left** of the last point. **Shift** toggles **Ortho** mode to constrain the cursor to 180 degrees.
9. Click **Close** to close the polyline.

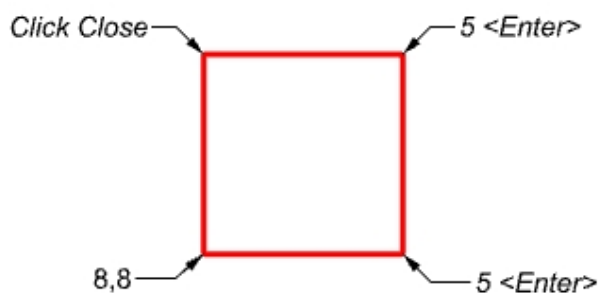

### Distance and angle constraint entry

1. On the **Curve** menu, click **Polyline**, and then click **Polyline**.
2. To **Start** type **16,5** and press **Enter**.
3. For the **Next point** type **5** and press **Enter**, then type **<45** and press **Enter**.  
As you drag your cursor around, the marker snaps to a distance of 5 and an angle of 45 degrees.

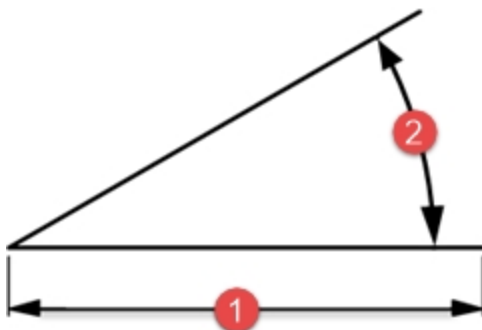

- (1) Distance constrain  
(2) Angle constraint.



4. Pick a point down and to the right of the previous point.  
The angle constraint sets the angle.
5. For the **Next point** type **5** and press **Enter**, then type **<45** and press **Enter**.
6. Pick a point up and to the right.  
The angle constraint sets the angle.
7. For the **Next point** type **5** and press **Enter**, then type **<45** and press **Enter**.
8. Pick a point up and to the left.  
The angle constraint sets the angle.
9. Click **Close** to close the polyline.
10. **Save** your model. You will use this model for another exercise.

## Exercise 6-2 The Arrow

In this exercise, you will practice using distance and angle constraint entry

1. Start a new model, use the **Small Objects - Millimeters.3dm** template. **Save as Arrow.**  
Since the object is symmetrical, you will only draw the lower half of the model.
2. Draw the arrow with a polyline, using a combination of absolute coordinates (x,y), relative coordinates (Rx,y), polar coordinates (Rdistance<angle), and distance constraint.

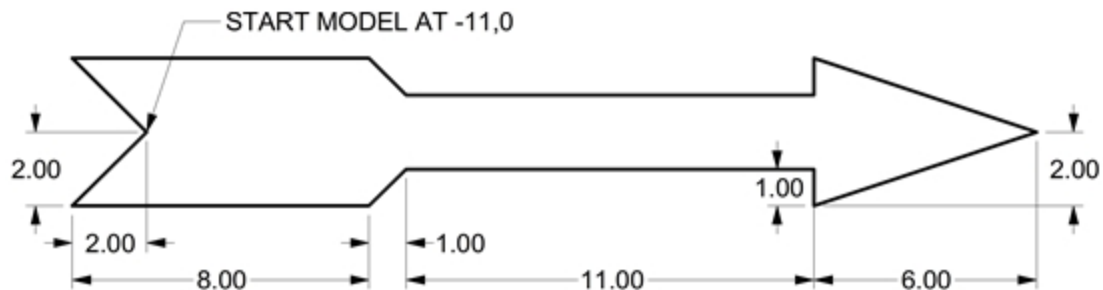

### Examples of the Command-line input

#### Absolute x,y

1. On the **Curve** menu, click **Polyline**, and then click **Polyline**.
2. For the **Start of Polyline** type **-11,0**.

#### Relative x,y

- ▶ For the **Next point**, type **r-2,-2**.

#### Distance constraint

- ▶ For the **Next point**, type **8** and press **Enter**, turn Ortho on, and then pick to the right.

#### Relative x,y

- ▶ For the **Next point**, type **r1,1**.

#### Relative polar

- ▶ For the **Next point**, type **r11<0**.

#### Distance constraint

1. For the **Next point**, type **1** and press **Enter**, turn Ortho on, and then pick down.
2. For the **Next point**, type **r6,2**.
3. For the **Next point**, press **Enter** to end the command.

4. **Save** your model.

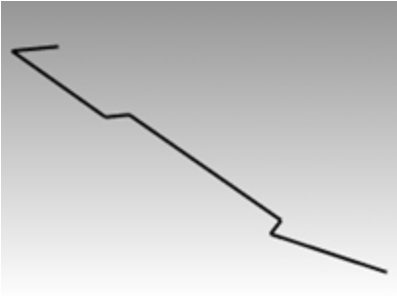

### Make a copy of the polyline

---

1. Select the polyline.
2. On the **Transform** menu, click **Copy**.
3. For the **Point to copy from**, pick a point near the polyline.
4. For the **Point to copy to**, type **6** and press **Enter**, turn **Ortho** on, and pick above the selected polyline.
5. Press **Enter** to end the command.

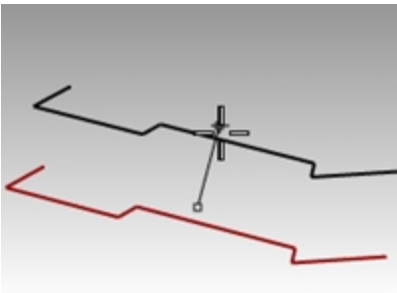

### Make a mirror image of the polyline

---

1. Select the original polyline.
2. On the **Transform** menu, click **Mirror**.
3. For the **Start of mirror** plane, type **0** and press **Enter**.
4. For the **End of mirror plane**, turn **Ortho** on, and then pick to the right.

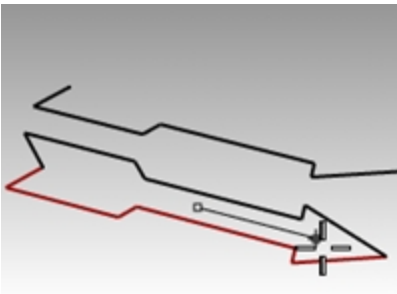

### Make it 3-D

---

1. Right-click  the **Perspective title**, and set the display mode to **Shaded**.
2. Select the original polyline and the mirror copy.
3. On the **Solid** menu, click **Extrude Planar Curve**, and then click **Straight**.

- For the **Extrusion distance**, type **1**, and press **Enter**.

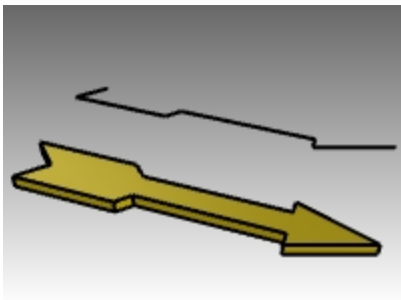

### Make it 3-D (alternate)

- Select the copy of the polyline.
- On the **Status Bar**, click **Osnap**.
- On the **Osnap** toolbar check **End**.
- On the **Surface** menu, click **Revolve**.
- For the **Start of revolve axis**, select the end of the polyline.
- For the **End of revolve axis**, select the other end of the polyline along the center line.
- Press **Enter** to use the default **Start angle**.
- Press **Enter** to use the default **Revolution angle**.

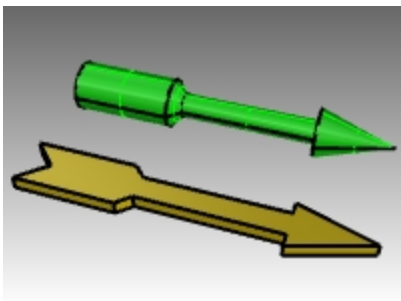

### Deform the shape with bend

- Select the 3-D arrow.
- On the **Transform** menu, click **Bend**.

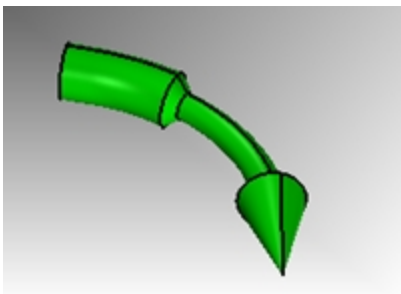

- For the **Start of spine**, click the end point on the left end of the arrow.
- For the **End of Spine**, click the end point on the right end of arrow.

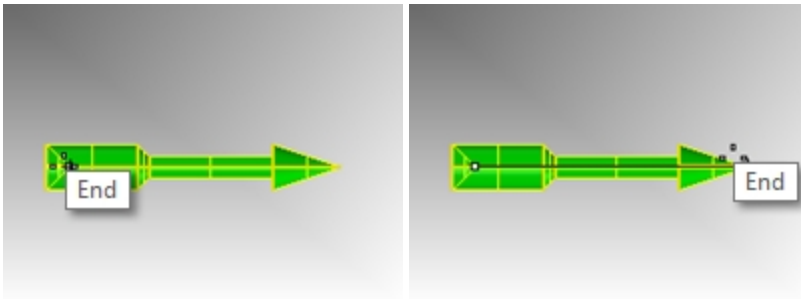

5. For the **Point to bend through**, drag the cursor down, and pick a point.

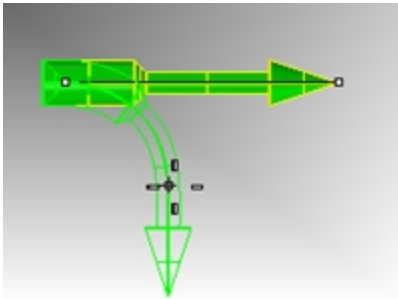

### Deform the shape with twist

1. Pick the extruded arrow.
2. Turn Ortho on.
3. On the **Transform** menu, click **Twist**.
4. In the **Top** viewport, pick the **Start of Twist** with the *End point* osnap at the left center end of the arrow.
5. Pick the **End of Twist** with the *End point* osnap at the right center end of the arrow.
6. At the **Angle or first reference prompt**, pick a point to the right or angle 0 direction in the **Right** viewport.
7. Then watch the **Perspective** viewport, move the cursor clock wise or counter clockwise. Pick to the right to fill an angle of 360.

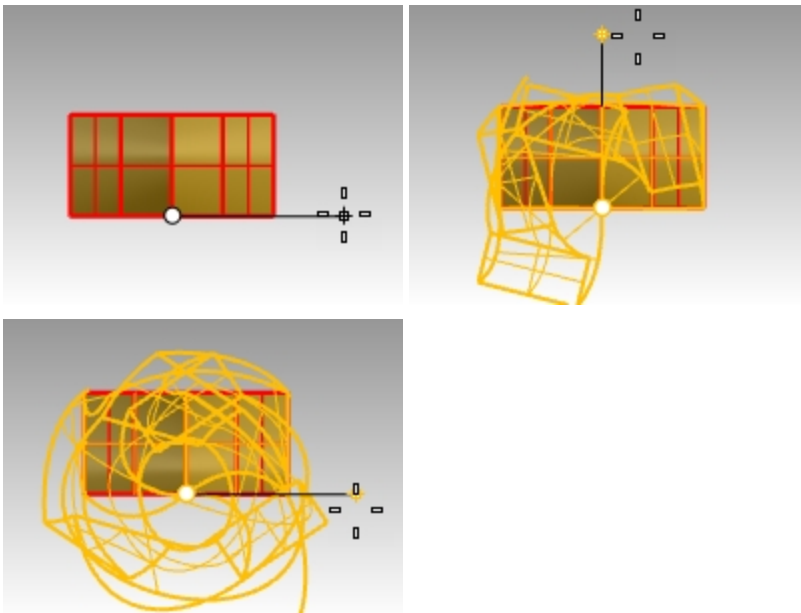

The twist transform is applied to the arrow solid.

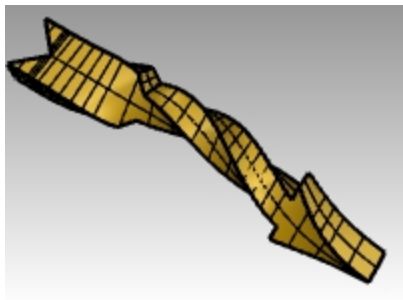

### Revolve to 3-D

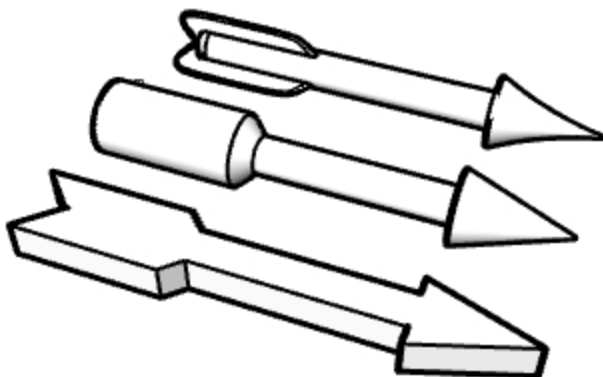

1. Open **Arrow Options.3dm**.
2. Revolve to create the three arrow options shown on the Picture in the file..
3. Discuss with your instructor how to create the more complex arrows.  
**Hint:** Try the Loft, Cap and Array Polar commands or come back to this exercise after the class.
4. Right click on the **Perspective** viewport, and select your favorite display mode.
5. Right click on the **Perspective** viewport and pick **Capture** and pick **To File**.

### Exercise 6-3 The V-block

1. Start a new model using the **Small Objects – Millimeters.3dm** template.
2. Save as **V-Block**.
3. In the **Front** viewport, double-click the viewport title to maximize it.
4. Create the following model in the front construction plane.
5. Draw the object below using a combination of absolute coordinates (x,y), relative coordinates (rx,y), and relative polar coordinates (rdistance<angle).
6. Start your model at **0** in the **Front** viewport.

Try to create the model using a single polyline in a clockwise direction.

7. In the **Front** viewport, double-click the viewport title to restore your views.

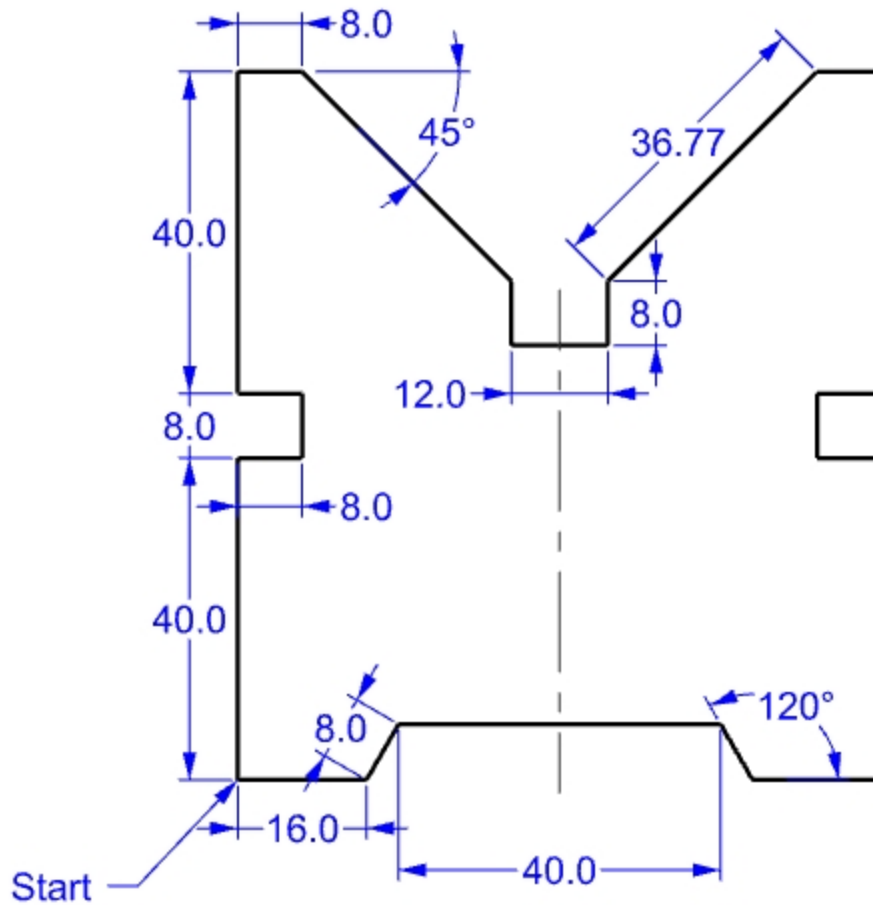

### Make it 3-D

1. Select the polyline.
2. On the **Solid** menu, click **Extrude Planar Curve**, and then click **Straight**.
3. For the **Extrusion Distance** type **150**, and press **Enter**.  
You can view the model as a three-dimensional object in the **Perspective** viewport.
4. **Save** your model.

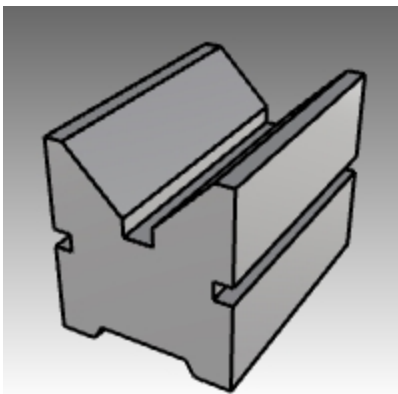

## Object Snaps

Object Snaps (*osnaps*) are tools for specifying points on existing objects. Use object snaps for precision modeling and to get accurate data. Object snaps are often referred to as object snaps. In Rhino, reliable modeling and easy editing depends on objects actually meeting at specified points. Objects snaps give you precision you cannot get using the "eyeball" method

### Open the Osnap toolbar

- Click the **Osnap** pane on the Status Bar.  
The display of the Osnap control is controlled with the Osnap pane on the Status Bar.

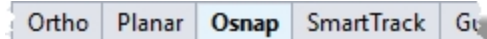

- Click it to toggle the display on and off.  
The Osnap control turns persistent object snaps on and off.



Use persistent objects snaps to maintain an object snap through choosing several points without having to reactivate the object snap.

When an object snap is active, moving the cursor near an eligible point on an object causes the marker to jump to that point and a tooltip to appear.

- Click a check box to turn on the object snap.
- Right-click a check box to turn on the object snap and clear all other object snaps.  
You can place the control anywhere on your desktop.

### Practice using object snaps

In this model we will practice using most of the object snaps listed on the toolbar.

## Exercise 6-4 Use osnaps

- Open the model **Osnap.3dm**.
- Toggle **Grid Snap** and **Ortho** off.

### End and Midpoint object snaps

- Click the **Osnap** pane on the Status Bar.  
You can leave the **Osnap** control displayed.



- Check **End** and **Mid**.  
Check and clear individual object snaps as needed.
- On the **Curve** menu, click **Polyline**, and then click **Polyline**.
- For the **Start of Polyline**, move your cursor close to the end of the line at the lower left corner of the first square and pick when the marker snaps to the end of the line.  
The line starts exactly at that corner.

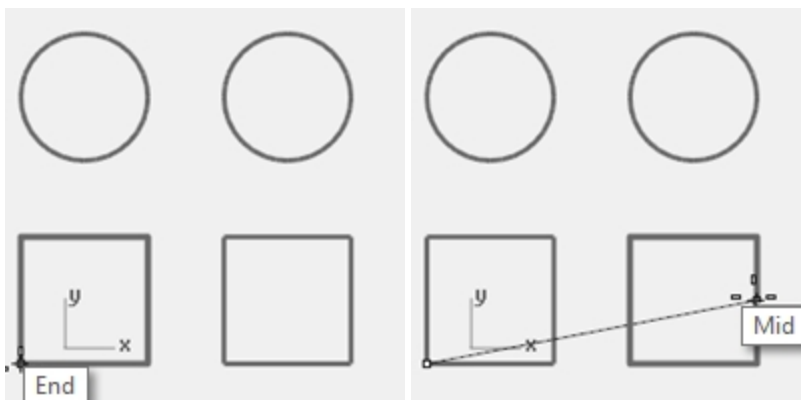

5. For the **Next point**, move your cursor close to the midpoint of the vertical line at the right side of the square on the right, pick when the marker snaps to the midpoint.  
The marker snaps to the midpoint of the line that the cursor touches, making the new line cross to the exact midpoint of that side.
6. For the **Next point**, move your cursor close to the end of the line at the upper left corner of the first square, pick when the marker snaps to the end of the line.  
The marker snaps to the end of the line.
7. Press **Enter** to end the command.

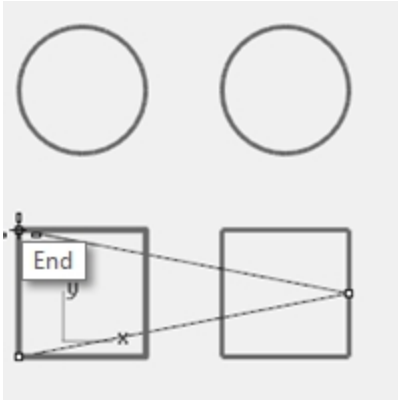

**Near and Perpendicular to object snaps**

1. On the **Osnap** control, check **Near** and **Perp**, clear **End** and **Mid**.
2. On the **Curve** menu, click **Line**, and then click **Single Line**.
3. For the **Start of line**, pick the lower edge of the circle at the top right.  
The marker snaps to the point on the circle nearest to where the cursor is positioned.
4. For the **End of line**, pick the top horizontal edge of the second square when the **Perp** tooltip appears.  
The marker snaps to a point making a perpendicular to the previous point.

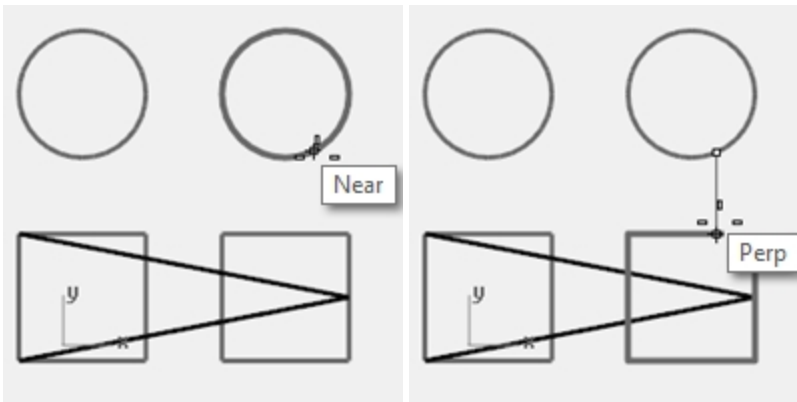



### Intersection and Tangent to object snaps

1. In the **Osnap** control, check **Int** and **Tan**; clear **Near** and **Perp**.
2. On the **Curve** menu, click **Line**, and then click **Single Line**.
3. For the **Start of line**, pick the intersection where the diagonal line crosses the vertical line on the first square.  
The marker snaps to the intersection between the two lines.

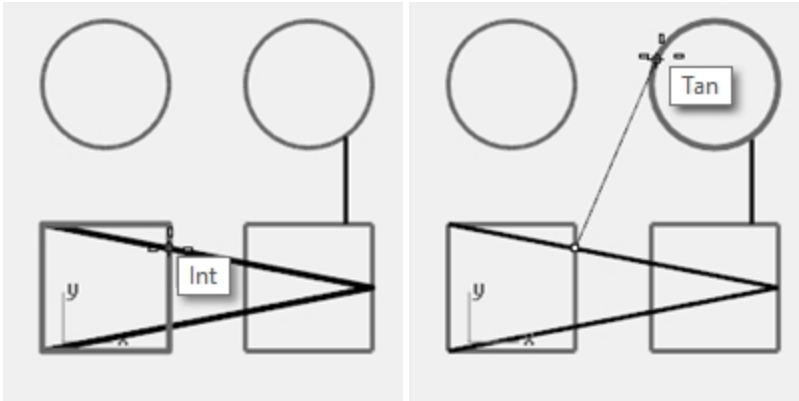

4. For the **End of line**, pick the top, left edge of the circle on the right.  
The marker snaps to a point tangent to the circle.

### Center of object snap

1. In the **Osnap** control, check **Cen**, clear **Int** and **Tan**.
2. On the **Curve** menu, click **Line**, and then click **Single Line**.
3. For the **Start of line**, pick the edge of a circle.  
The marker snaps to the center of the circle.
4. For the **End of line**, pick the edge of the other circle.  
The marker snaps to the center of the circle.

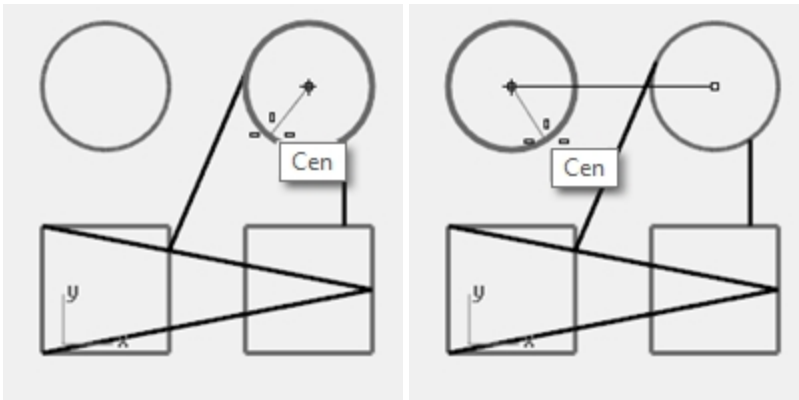

### Quadrant of object snap

1. In the **Osnap** control, check **Quad**, clear **Cen**.
2. On the **Curve** menu, click **Polyline**, and then click **Polyline**.
3. For the **Start of Polyline**, pick a point on the top edge of the first circle.  
The marker snaps to the quadrant point of the circle.

- For the **Next point**, pick the left edge of the circle.  
The marker snaps to the quadrant point of the circle.

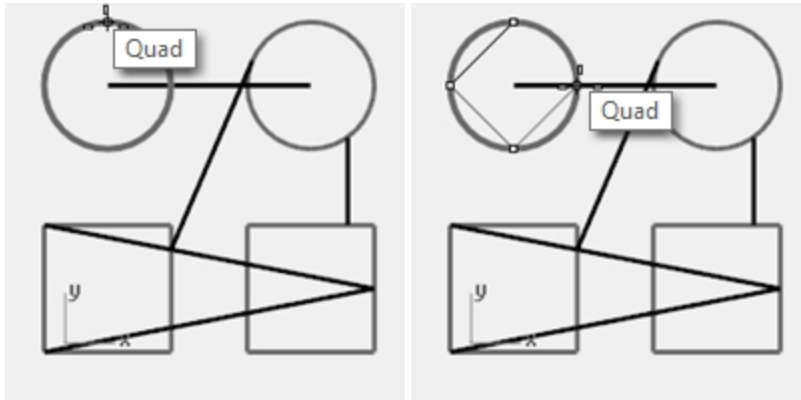

- For the **Next point**, pick the bottom edge of the circle.
- For the **Next point**, pick the right edge of the circle.
- Click **Close** to finish.
- Use the **SaveAs** command to save the model.
- Name it **Analyze**.

We will use it for a later exercise.

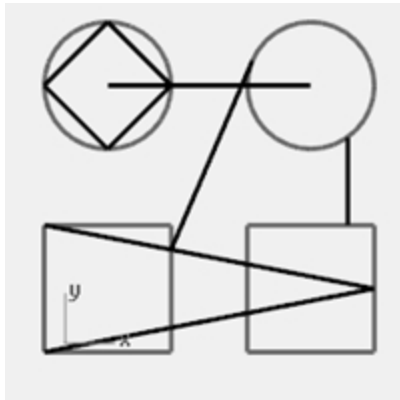

## Analysis commands

Rhino provides analysis tools for finding lengths, angles, areas, distances, and the volume and centroid of solids. Additional commands let you analyze curve curvature, determine continuity between curves, and find unjoined edges.

### Exercise 6-5 Analyze the model

#### Distance

Measures the distance between two picked points.

#### Find the distance between two points

- Open** the model **Analyze.3dm** that you saved from an earlier exercise.  
If you didn't get a chance to save the model, open the model **Analyze-01.3dm** instead.
- On the **Analyze** menu, click **Distance**.

- For the **First point**, pick the intersection where a diagonal line intersects a vertical line.  
Use the Int object snap.

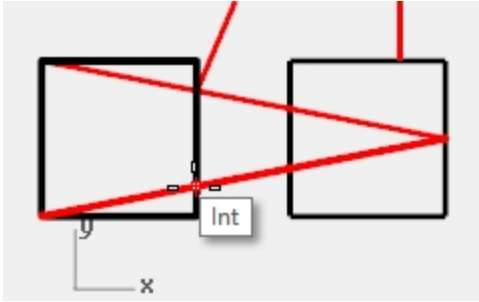

- For the **Second point**, pick the intersection where the other diagonal line intersects the same vertical line.

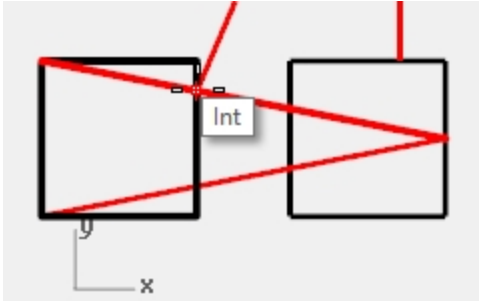

- Press **F2** to display the information.

CPlane angles and deltas: xy = 90 elevation = 0 dx = 0 dy = 3.077 dz = 0  
World angles and deltas: xy = 90 elevation = 0 dx = 0 dy = 3.077 dz = 0  
Distance = 3.077 millimeters

## Length

Displays the length of a selected line.

### Find the length of a line

- On the **Analyze** menu, click **Length**.
- Select the line between the centers of the circles.

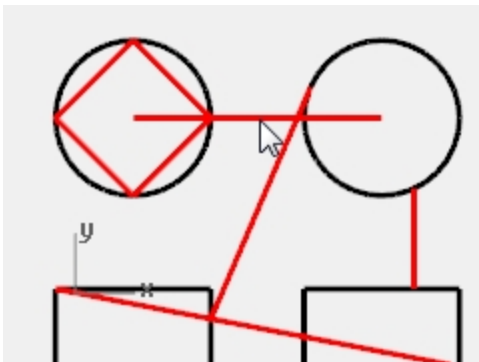

Length = 8.000 millimeters

### Measure the angle between two lines

1. On the **Analyze** menu, click **Angle**.
2. Select a point that defines the vertex of an angle line.

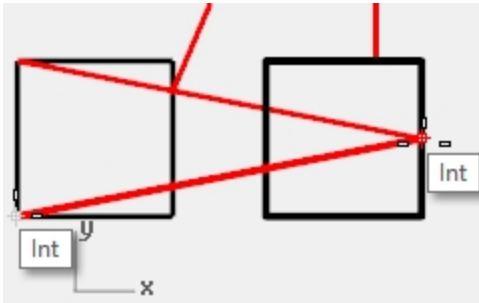

3. Select a point that defines the end of an angle line.  
Use object snaps as appropriate.

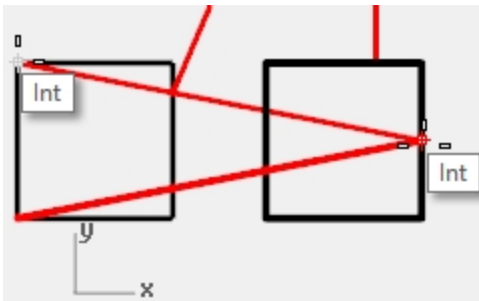

4. Select a point that defines the vertex of the second angle line.
5. Select a point that defines the end of the second angle line.  
The angle displays in the command-line in the following format: Angle = 21.7711

### Radius

Displays the radius of a circle, arc, or curve segment.

#### Measure the radius of a circle

1. On the **Analyze** menu, click **Radius**.
2. Select one of the circles.

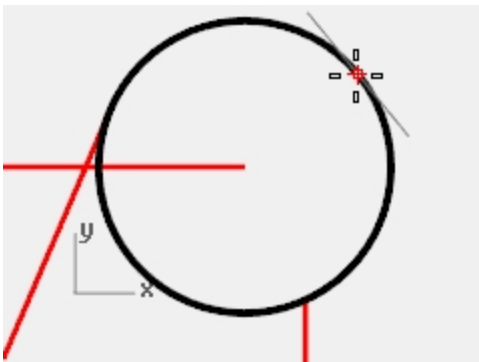

This also measures the radius of curvature of a curve at a point.  
The radius displays in the command-line in the following format:  
Radius = 2.5

### Point evaluation

Displays the coordinates of a picked location.

## Display the coordinates of a point

1. On the **Analyze** menu, click **Point**.
2. Snap to the end point of the tangent line.

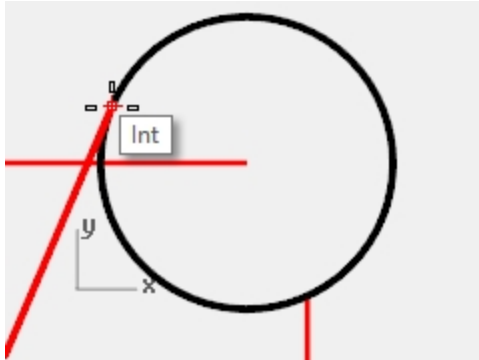

The x,y,z point is displayed for the world coordinate plane and the current construction plane.

Point in world coordinates = 8.203,11.488,0.000

CPlane coordinates = 8.203,11.488,0.000

## Additional modeling aids

As well as allowing the user to work in a completely unconstrained free-form manner Rhino has a number of modeling aids and constraints that help with precision modeling. This section outlines these aids and constraints.

### SmartTrack

SmartTrack creates a set of temporary reference lines and points that work in conjunction with Rhino's object snaps. Using SmartTrack obviates the need to create dummy reference lines and points. SmartTrack works on both 2-D and 3-D objects. It can be used in conjunction with the Project and Planar constraints described later in this section.

## Exercise 6-6 Use SmartTrack

1. **Open** the model **Constraints.3dm**.
2. Maximize the **Top** viewport.
3. Make sure that the following object snaps are turned on: **End**, **Near**, **Point**, **Mid**, **Cen**, and **Int**.
4. Turn on **SmartTrack** on the **Status Bar**.
5. On the **Curve** menu, click **Point Object**, then click **Single Point**.
6. Hover the cursor over the lower left corner of the green rectangle, the End snap will be displayed and a white marker point becomes visible.
7. Repeat this process on the bottom left hand corner of the gold rectangle.

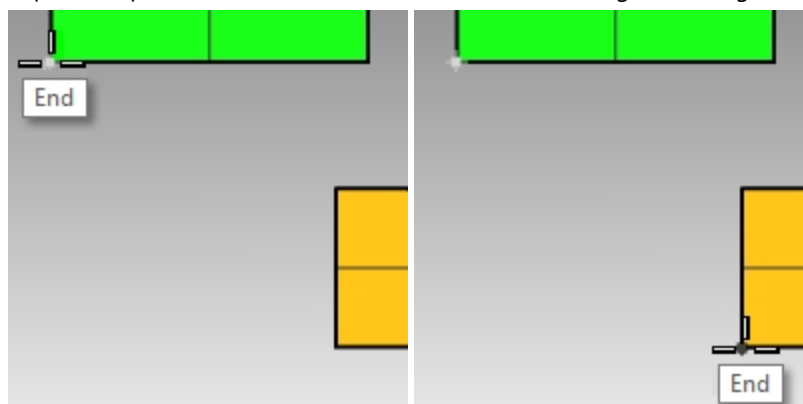

8. Move the cursor towards the apparent intersection point of these two corners. Two temporary construction lines are displayed. The point is positioned on the intersection of these two construction lines.

- Click to place the point object.  
SmartTrack will work with any of the available object snaps. Experiment with some alternatives.

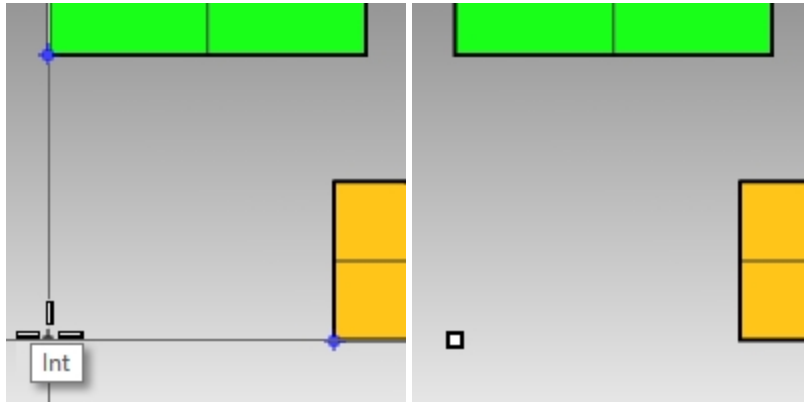

### Tab Constraint

The Tab constraint lets you fix a direction to a reference point and thereby constrain cursor movement. The following example shows a simple use of the Tab constraint.

#### Use the Tab constraint

- In the **Constraints.3dm** file, maximize the **Top** viewport.
- Turn off **SmartTrack**.
- On the **Curve** menu, click **Line**, then click **Single Line**.
- For the **Start of Line**, snap to the end of the bottom left hand corner of the gold rectangle.

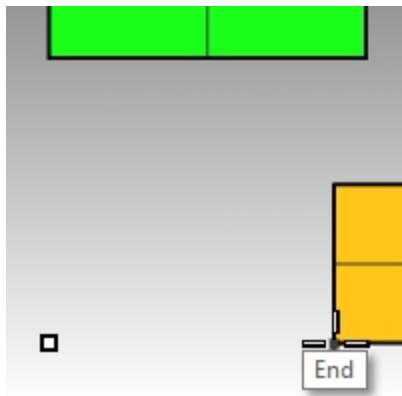

- For the **End of Line**, hover the mouse over the bottom left hand corner of the green rectangle, when the **End** snap appears, press the **Tab** key.

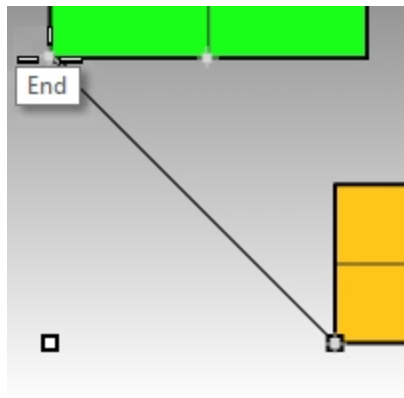

**Note:** The line now becomes white and the direction is constrained.

6. For the **End of Line**, drag your mouse to the desired location and click.

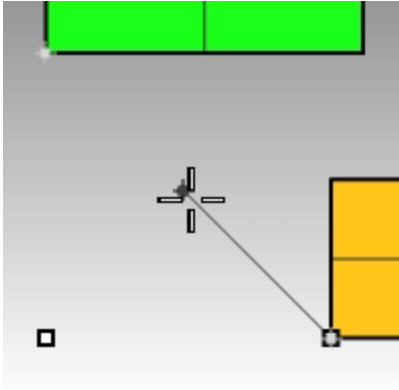

The **Tab** constraint will work in conjunction with all object snaps and all tools that require a directional input, for example **Move**, **Copy**, and **Rotate**.

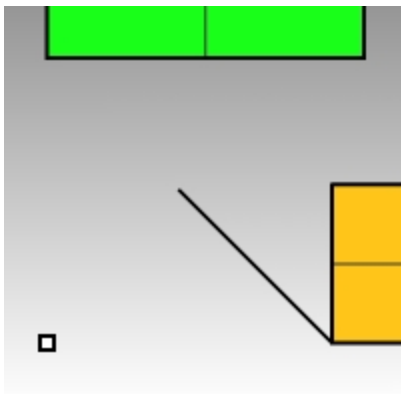

### **Project constraint**

By default 2-D geometry is created on the active construction plane. Object snaps override this behavior and snapping to objects that are not on the construction plane will cause the geometry to be non-planar. The Project constraint ignores objects snaps and pushes all the geometry onto the active construction plane.

### Use the Project constraint

1. Use the **Constraints.3dm** file, as previous section.
2. Make sure that the **Ortho** constraint is **On**.
3. Turn **Layer 01 off** and turn **Layer 02 on**.  
The surfaces on Layer 02 are located at different elevations.

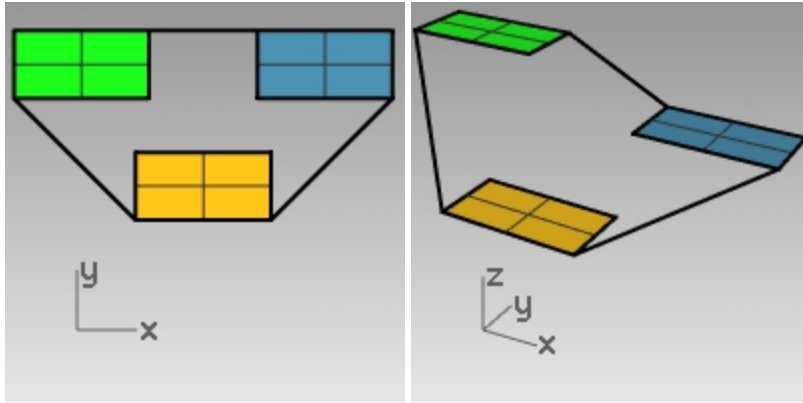

4. On the **View** menu, click **Zoom**, then click **Zoom Extents**.
5. Double-click the **Top** viewport title to restore the four view layout.
6. In the **Top** viewport, draw a **polyline** around the perimeter of the three rectangles.  
In the **Perspective** viewport, notice how the planar nature of the polyline is overridden by the object snaps.
7. **Delete** the polyline.
8. **Turn on** the **Project** constraint on the **Osnap** toolbar.
9. In the **Top** viewport, draw a polyline around the perimeter of the three rectangles.

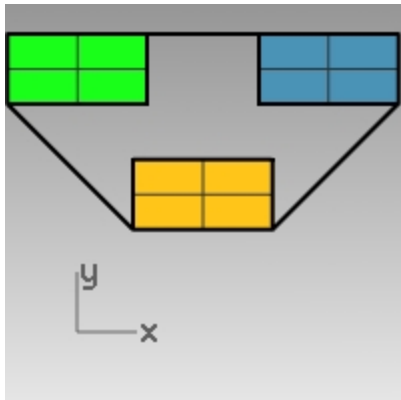

Look in the **Perspective** viewport as you draw the polyline and note how the object snaps for the endpoints of the green and blue rectangles are projected to the construction plane.

The Project constraint forces all the segments of the polyline onto the construction plane. The resulting polyline is planar.

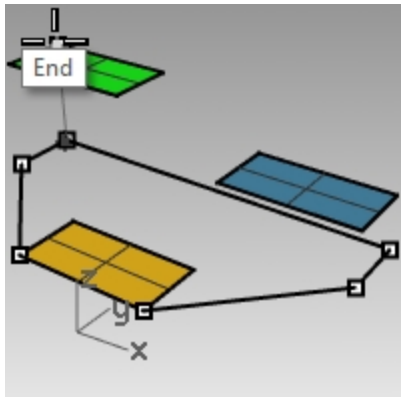

10. **Delete** the polyline.



## Planar constraint

The Planar constraint limits successive picked locations to the same construction plane elevation as the previous location. For example, a command such as Polyline can be started off the construction plane and the Planar constraint will override Rhino's default behavior of snapping back to the construction plane.

We will first look at what happens with the Planar constraint Off. Then, we will turn the Planar constraint On to see what changes.

### Use the Planar constraint

1. In the **Constraints.3dm** file, turn off the **Ortho** and **Planar** constraints, and **Project** object snap.
2. In the **Top** viewport, start a **Polyline** at the lower left corner of the green rectangle.
3. Add some more segments without snapping to any of the objects.

Look at the **Perspective** viewport, and notice how the polyline pulls back onto the construction plane after the initial point.

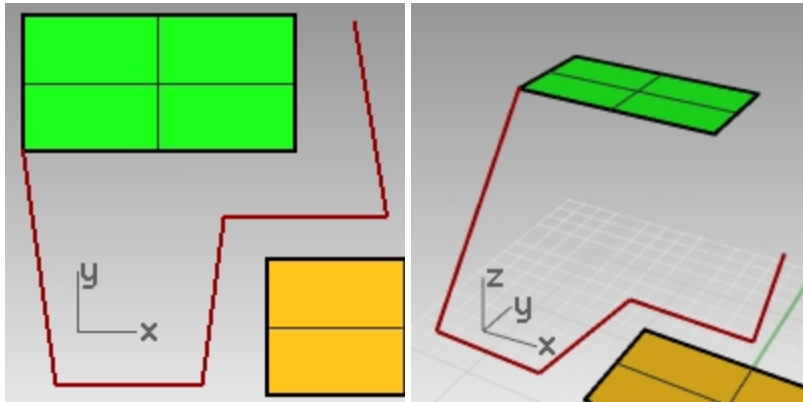

4. **Delete** the polyline.
5. To create a planar curve turn on the **Planar** constraint.
6. Draw the **polyline** again.

It now stays on the same plane as the first point.

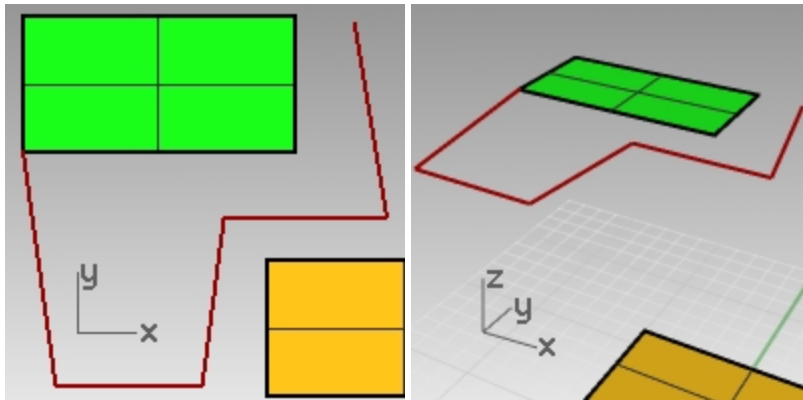

7. **Delete** the polyline.

### Create a planar curve above the active construction plane

First we will draw a polyline without the Project constraint activated. Then we will use the planar constraint in conjunction with the Project constraint to see what changes.

1. Turn the **Planar** constraint **On**.
2. In the **Top** viewport, draw a new **Polyline** starting again at one of the corners of the green rectangle.
3. Create some additional points this time snapping to some of the blue and gold rectangle corner points. Look at the **Perspective** viewport and note how the object snaps override the **Planar** constraint.

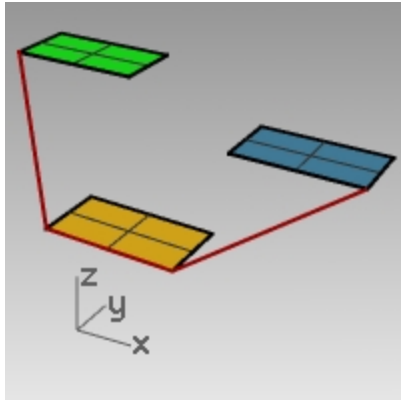

4. **Delete** the polyline.
5. In the **Perspective** viewport, draw a new polyline starting again at one of the corners of the green rectangle.
6. After making the first point, turn the **Project** constraint **On**.
7. Create some additional points, snapping to some of the blue and gold rectangle corner points. Notice that the points stay planar to the first point, even though you are snapping to points that are at different elevations.

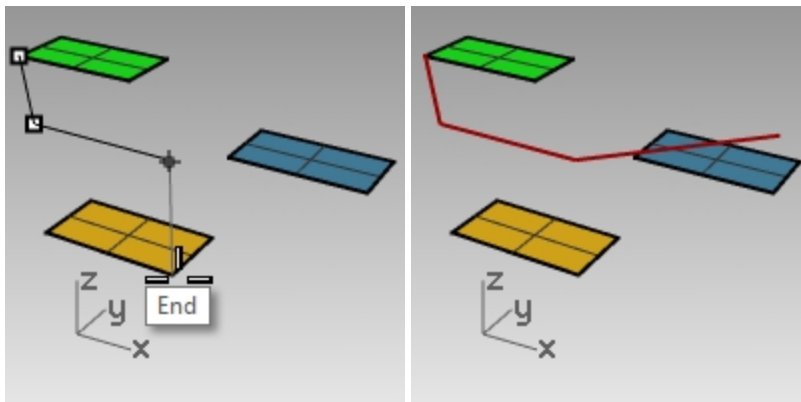

## Introduction to construction planes

In the following exercise, you will practice using object snaps while learning more about viewports and construction planes.

You will transform the surfaces in this model, set a construction plane to each surface and then name the construction plane in the **Named CPlanes** panel.

The CPlanes are saved with each file and can be restored by name later, even in a future editing session.

In this introduction to CPlanes, we will be using the **3Point** option in the **CPlane** command. The 3 points are the origin, a point on the x axis and a point on the y axis

1. Use the **Constraints.3dm** file, as in the previous section.
2. Turn off **Layer 01** and **Layer 02**. Turn on **Layer 03**.
3. Zoom in on the green surface.

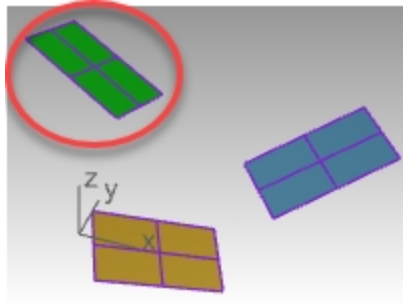

4. On the **View** menu, pick **Set CPlane** and **3 points..**
5. For the **CPlane origin**, pick in the lower left corner of the surface.

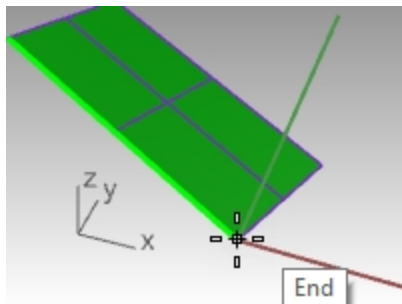

6. For the X axis direction, pick in the adjacent corner.

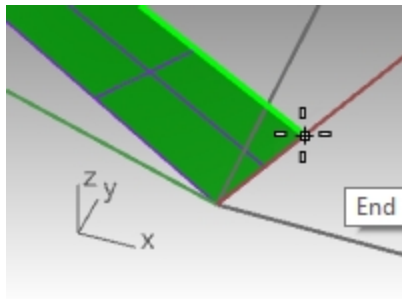

7. For the Y axis direction, pick in the edge of the surface.

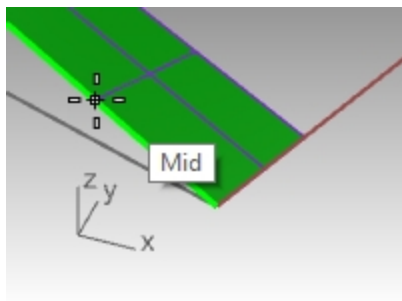

8. Now the CPlane is set to the green surface.

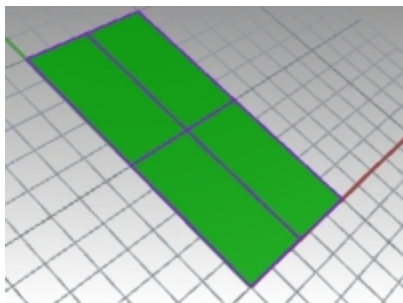

9. Type the **Plan** command . This will Set the viewport to the parallel and plan view of the green surface.

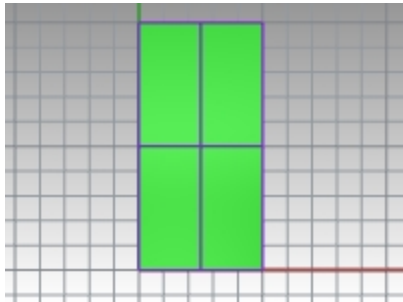

10. From the **Curve** menu, pick **Circle** and **Center radius**.
11. Draw a circle on the green surface.

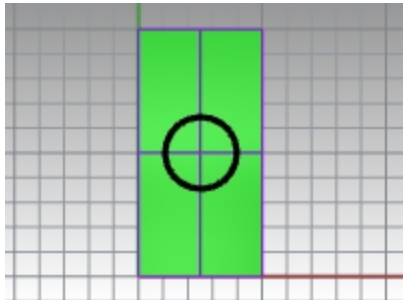

12. Open the **Named CPlanes** panel. Pick the Save button. Type in the name **Green**.

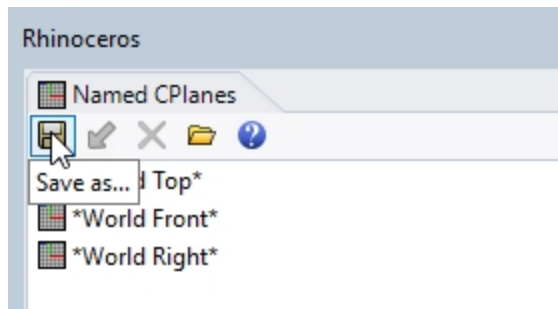

13. On the **View** menu, pick **Set View** and **Perspective**.
14. On the **Named CPlanes** panel, Double-click on **World Top**.

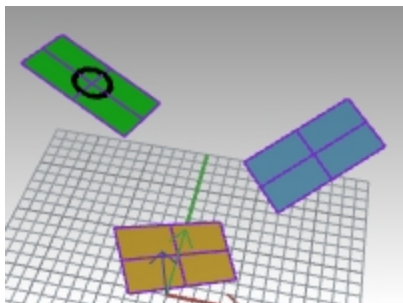

15. Repeat steps above and save both **Blue** and **Gold** custom construction planes in the **Names CPlanes** panel.
16. Save model.

## Exercise 6-7 Using construction planes

- ▶ Open the model **CPlanes.3dm**.

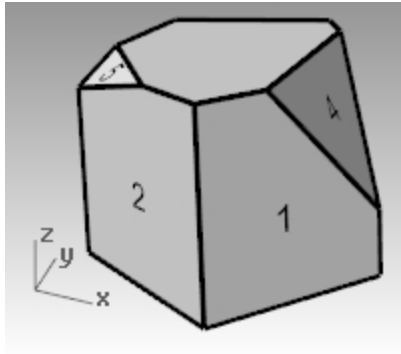

### Construction planes

The construction plane is the guide used for modeling Rhino objects. Points you pick are always on the construction plane, unless you use coordinate input, elevator mode, or object snaps.

- Each viewport has its own construction plane.
- Each construction plane has its own axes, a grid, and an orientation relative to the world coordinate system.
- The grid is a plane of perpendicular lines lying on the construction plane. On default grids, every fifth line is slightly thicker.
- The red line represents the construction plane x-axis. The green line represents the construction plane y-axis. The red and green lines meet at the construction plane origin.
- The icon in the left hand corner always shows world coordinates, which are different from the construction plane axes.
- Default construction planes are provided with the default viewports.

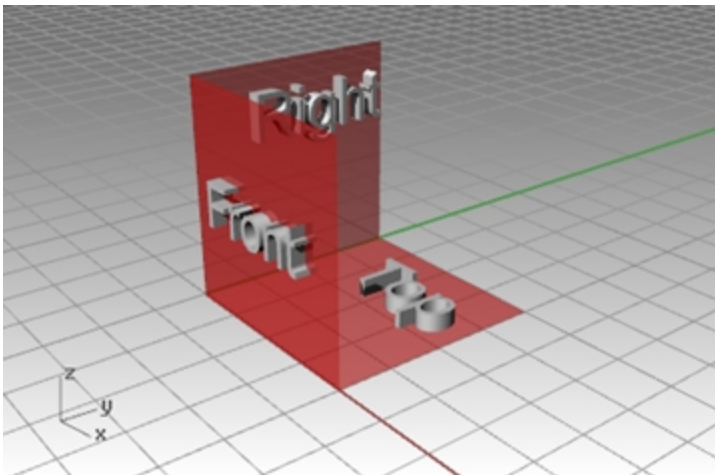

- The **Top** construction plane x- and y-axes align with the world x- and y-axes.
- The **Right** construction plane (x- and y-axes) align with the world y- and z-axes.
- The **Front** construction plane (x- and y-axes) align with the world x- and z-axes.
- The **Perspective** viewport uses the Top construction plane.

To set construction planes:

- Type **CPlane**.
- Select from the **View** menu.
- Right-click  on the viewport title.
- Click the **arrow** on the viewport title.

There are many options to the **CPlane** command. In this exercise, you will work with:

- Origin
- 3 Point
- To Object
- Named CPlanes

### Change a construction plane

1. On the **View** menu, click **Set CPlane**, and then click **3 Points**.
2. For the **CPlane origin**, snap to the lower left corner of the surface labeled **1**.

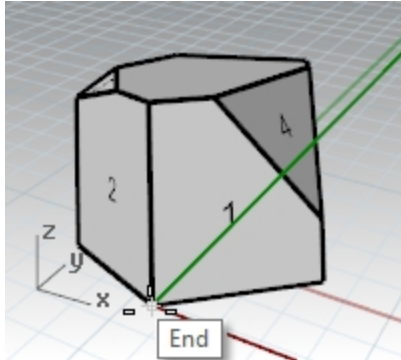

3. For the **X axis direction**, snap to the lower right corner of the surface labeled **1**.

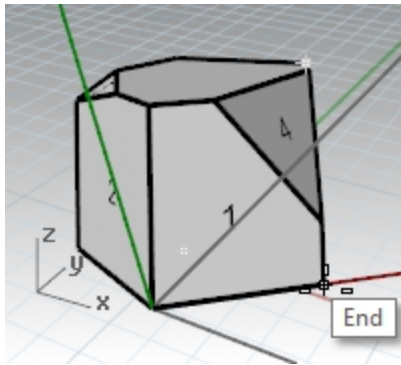

4. For the **CPlane orientation**, snap to the upper left corner of the surface labeled **1**.  
Now the construction plane is set.

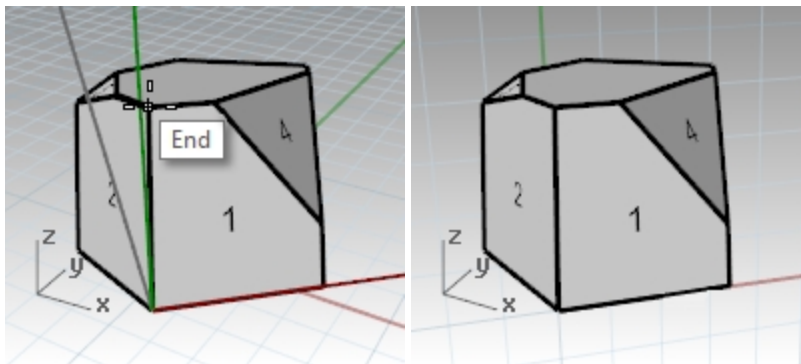

5. On the **Solid** menu, click **Cylinder**.

- For the **Base of cylinder** and **Radius**, pick points anywhere on the new construction plane.
- Drag and click to place the **End of cylinder**.

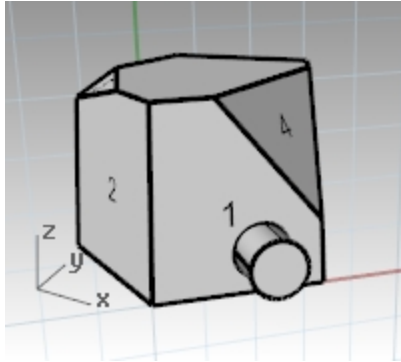

### Save the new construction plane

- On the **View** menu, click **Set CPlane**, and then click **Named CPlanes**.
  - The **Named CPlanes** panel opens.
  - Click the **Save as** button in the toolbar area.
  - Type a name** or use the default name **CPlane 01**, click **OK**.
- You have a named construction plane that can be restored at any time.

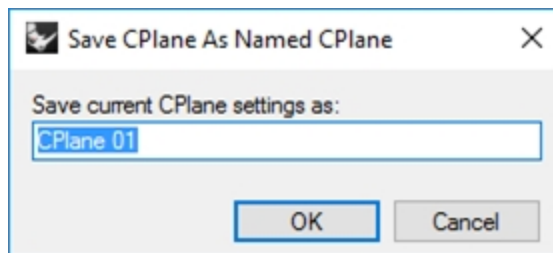

- Repeat setting and saving named construction planes for surfaces labeled **2** and **3**.

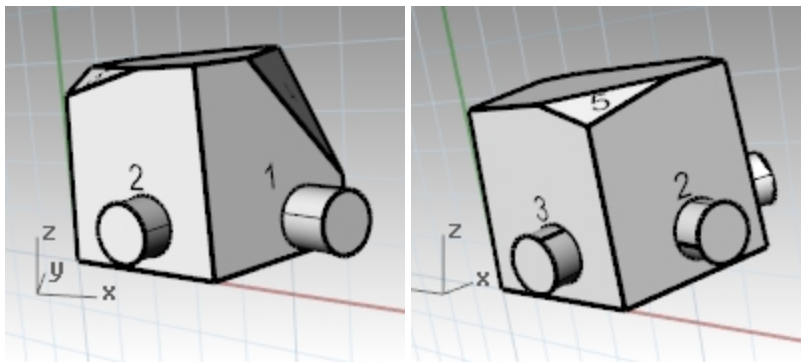

### Set a construction plane to an object

- On the **View** menu, click **Set CPlane**, and then click **To Object**.
- Select the surface labeled as **4**.  
The construction plane is set to the surface. The origin of the new construction plane is the center of the

underlying untrimmed surface.

- Using **Named CPlanes**, name this construction plane **CPlane 04**.

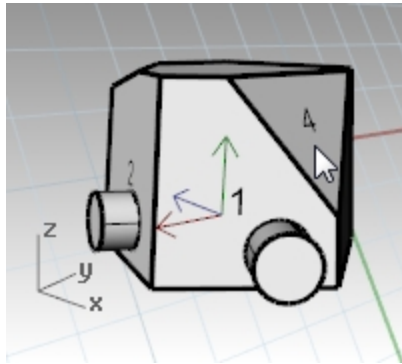

### Change the construction plane origin

- On the **View** menu, click **Set CPlane**, and then click **Origin**.
- For the **CPlane origin**, snap to the upper left corner of the surface labeled **4**.

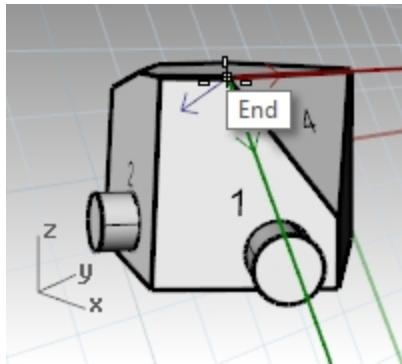

- Set a **CPlane by Object** for the surface labeled **5**.
- Set a new **CPlane Origin** for the surface labeled **5**.
- Using **Named CPlanes**, name this construction plane, **CPlane 05**.

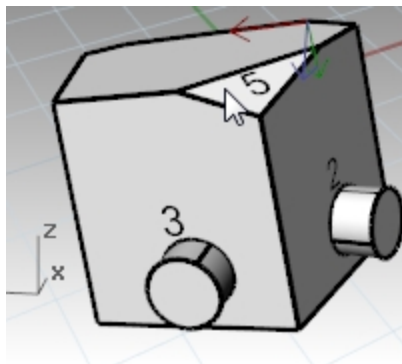

## Exercise 6-8 The Chair

### Viewports and construction planes

- Open** the model **Chair.3dm**.
- Each layer contains an image for a chair. Later in this exercise we will create our own chair.
- Turn the following layers on:
  - CP-Top
  - CP-Front
  - CP-Right



Each of the layers contains an image of a view of a tubular chair.

Notice that all the chair images intersect at the origin of the model (0,0,0).

When you draw on any viewport the geometry will be located on the construction plane, unless you use constraints.

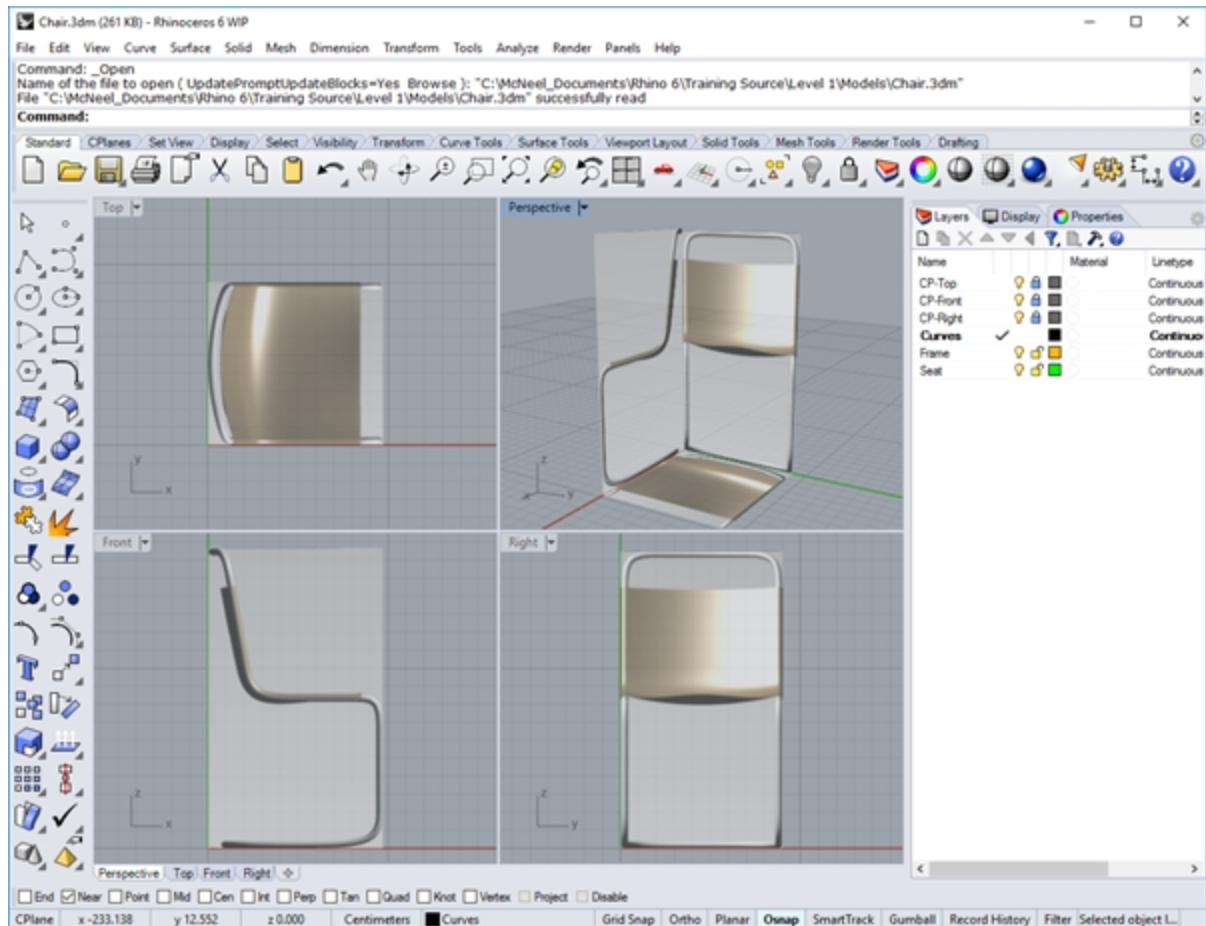

## Modeling in 3-D space

### Chair: Technical Method (*Recommended*)

Rhino makes it easy to draw in 3-D space. You can draw on a different construction plane by simply moving your cursor into a different viewport.

- Reference the technical drawing below, to input the precise curves for the chair with coordinate input.
- If precision is not required, you may trace the picture of the chair to generate the curves for the chair frame.
- When you have completed the curves, go to section "*Finishing the chair.*"

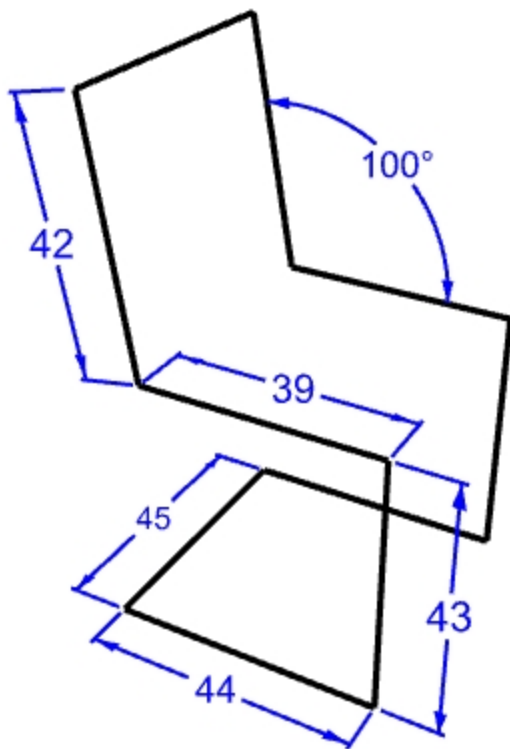

### Set up the model

1. Toggle **Planar** on and **Grid Snap** on.  
Toggle **Ortho** on as needed.
2. Turn on the **Point** object snap.

### Draw a polyline

1. On the **Curve** menu, click **Polyline**, and then click **Polyline**.
2. Move your cursor into the **Front** viewport.
3. For the Start of line, type absolute coordinate **4,2,Enter** and **Pick**.
4. With Ortho on, drag the cursor to the right and lock the 0 angle, type **44,Enter** and **Pick**.
5. Drag the cursor vertical and lock the 90 angle, type **43,Enter** and **Pick**.
6. Drag the cursor to the left and lock the 180 angle, type **39,Enter** and **Pick**.
7. Using angle constraint, type **<100** and **Enter**. Next type **42,Enter**.

8. Lock your cursor on the angle of 100 degrees and distance of 42.

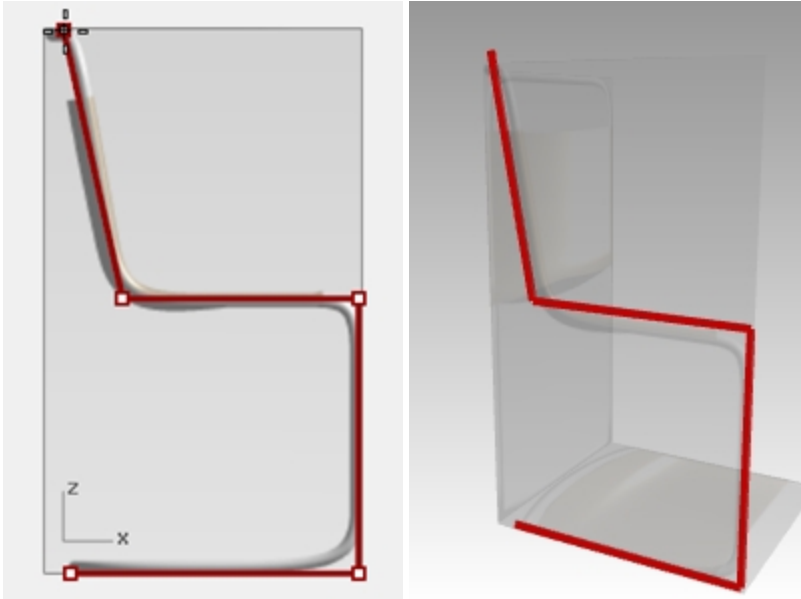

9. Confirm your inputs with a **Pick** and **Enter** to end the command.  
 10. From the Curve menu, pick **Line** and **Single Line** command. Move your cursor to the **Right** viewport. With the **End pt** osnap, pick the **Start of line** at the end point of the last polyline.  
 11. Drag the cursor to the right, lock the 0 angle, and type **45**, **Enter**, **Pick**.

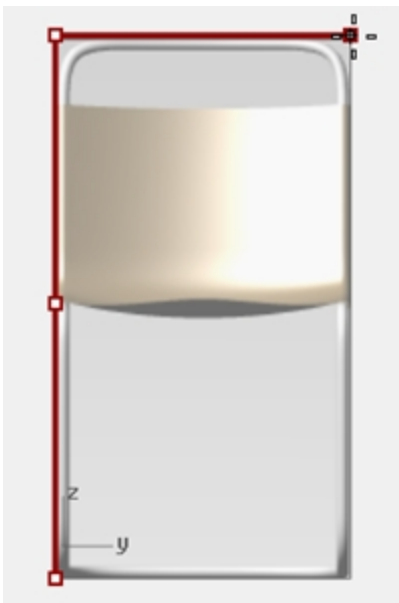

12. Select the polyline profile curve, however do not include the last line curve.  
 13. On Transform, select **Copy**.  
 14. For the **Point to copy from**, pick with the **End point** osnap.

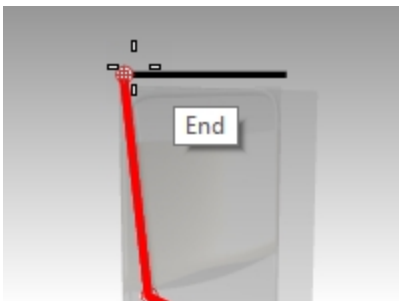

- For the **Point to copy to**, pick at the other end of the line.

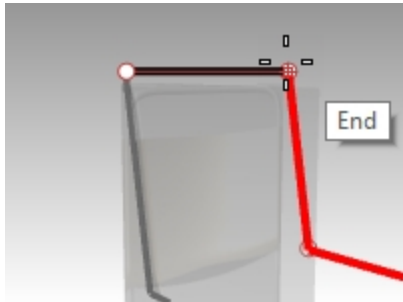

- Draw a line to connect both profile. Use the **End point** osnap.

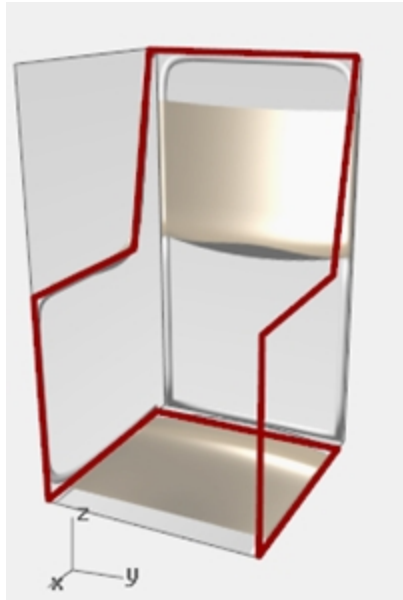

- Select the frame curves.
- Use the **Join** command to join the curves into one polyline.

### Finish the chair

After creating the chair curve, you now need to construct the chair surfaces. It will help to first create a custom construction plane aligned to the back of the chair.

#### Make a custom construction plane

- On the **Osnap Bar**, verify **End** is checked.
- Change to the **Perspective** viewport, and press **F7** to **turn on the Grid**.
- On the **View** menu, click **Set CPlane**, and then click **3 Points**.
- For the **CPlane origin**, pick end (1).
- For **X axis direction**, pick end (2).

- For the **CPlane orientation**, pick end (3).  
The construction plane is aligned with the back of the chair.

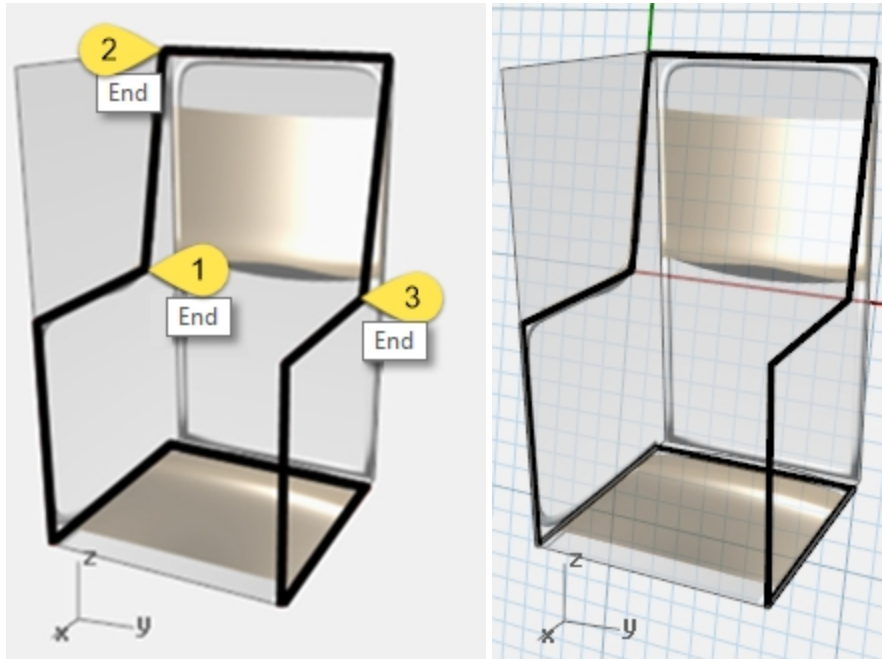

#### Create a named construction plane

- On the **View** menu, click **Set CPlane**, and click **Named CPlanes**.
- In the **Named CPlanes** panel, click **Save**.
- In the **Save CPlane** dialog, type **ChairBack**, then click **OK**.  
**Note:** You have a custom construction plane that can be restored as needed. This custom construction plane is saved in the file.

#### Create a named view

- On the **View** menu, click **Set View**, click **Plan**.  
The view changes. You are looking straight down on the new construction plane.
- On the **View** menu, click **Set View**, click **Named Views**.
- In the **Named Views** panel, click **SaveAs**.
- In the **Save Viewport As Named View** dialog, type **ChairBack**, then click **OK**.  
This creates a custom view that can be restored as needed.
- Make the **Perspective** viewport current.

6. On the **View** menu, click **Set View**, then click **Perspective**.
7. Draw some lines on the new construction plane.

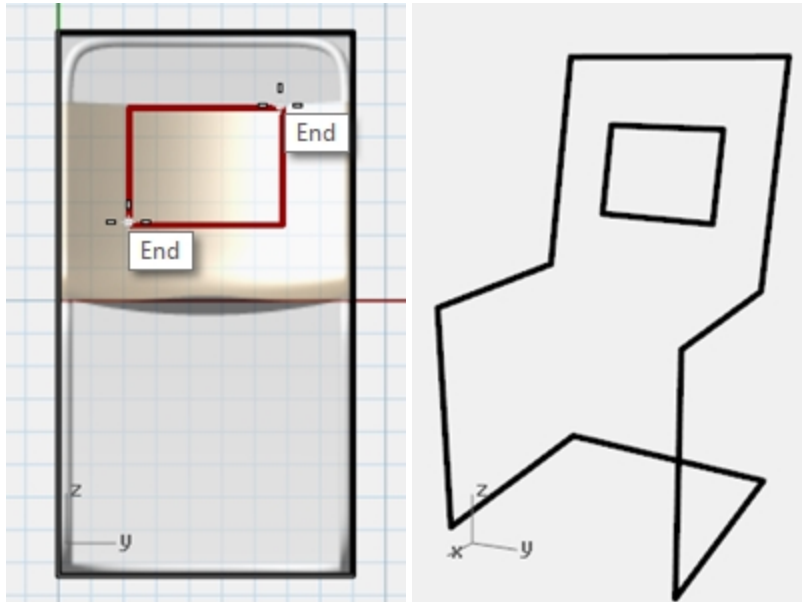

### Make it solid

1. Make the **Frame** layer current.
2. Select the chair frame.
3. On the **Solid** menu, click **Pipe**.
4. For the **Start** and **End Radius**, type **3**, and press **Enter**.  
The chair has a solid frame.
5. **Save** the model.

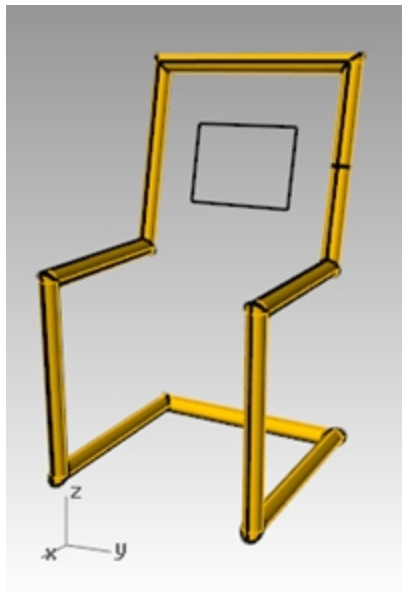

## Fillet the corners

1. **Undo** the pipe.

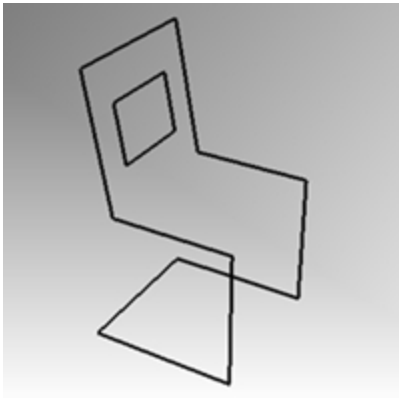

2. Select the chair frame.
3. On the **Curve** menu, click **Fillet corners**.

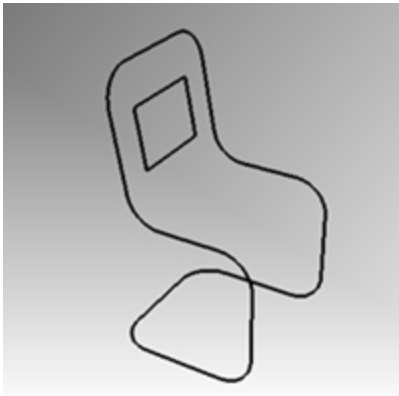

4. Click **Radius** and type **10** and press **Enter**.  
The fillet will be applied to all the chair corners.

## Make the back and seat surfaces

1. Select the curves you just filleted.
2. Make the **Seat** layer current.
3. On the **Edit** menu, click **Explode**.
4. To create a back surface, on the **Surface** menu, click **Edge Curves**.
5. Select the two side edges of the back of the chair, then press **Enter**.

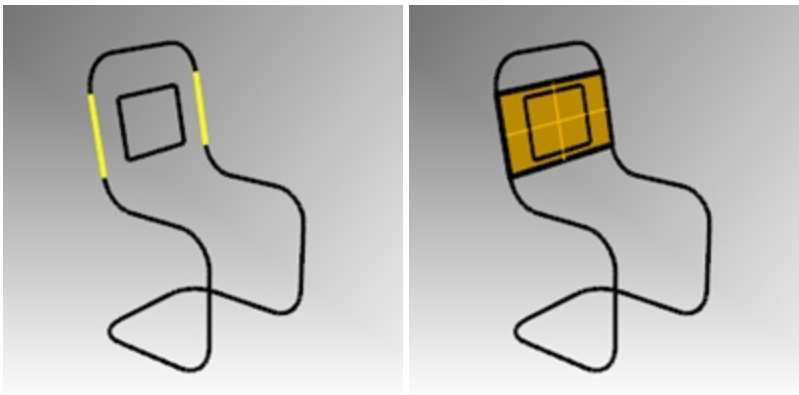

6. Repeat this procedure for the additional back and seat surfaces.

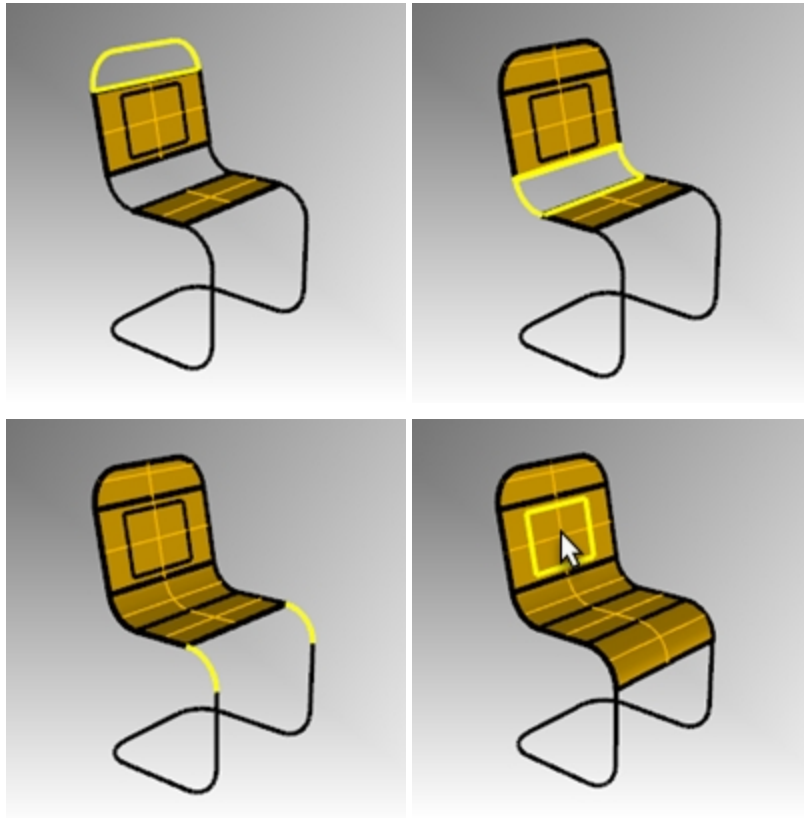

#### Join the seat surfaces and trim

---

1. Select all the seat surfaces.
2. On the **Edit** menu, click **Join**.



The seat will be joined into one polysurface.



---

**Trim the opening in the back.**

---

1. Select the rectangular curve you created earlier.
2. On the **Edit** menu, click **Trim**.
3. Click the part the surface that is inside the rectangle to trim the chair back.

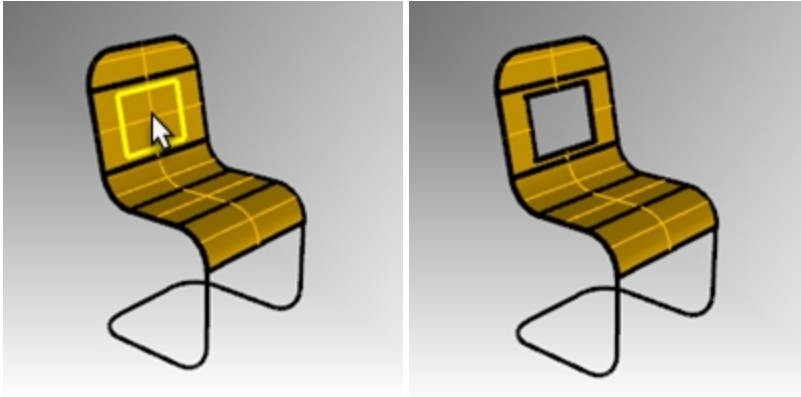

---

**Create the frame pipe**

---

1. Make the **Frame** layer current.
2. Turn off the **Seat** layer.
3. Select the curves for the frame.



4. On the **Edit** menu, click **Join**.
5. Use the **Pipe** command to make the new curves into a tubular frame.

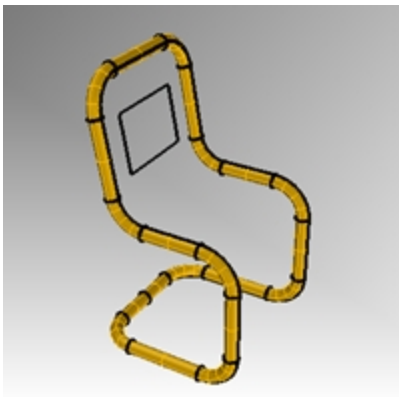

6. Turn **Seat** layer back on.



7. **Render** your model.

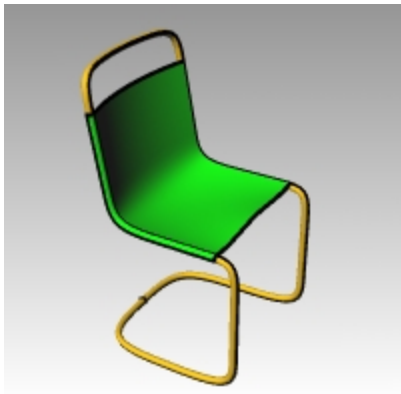

---

### On your own

- ▶ Try modeling a variation to the chair design.



*Chair Designs by Vanessa Steeg*

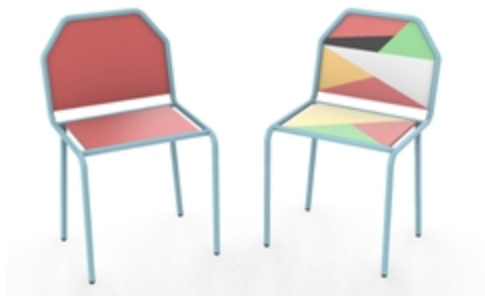

*Chair Designs by Doaa Alsharif*

## Draw circles with precision

You can create circles using a center point and radius, center point and a diameter, two points on the diameter, three points on the circumference, and tangent points to two coplanar curves and a radius.

## Exercise 6-9 Practice with Circles

### Draw a center, radius circle

1. Open the model **Circles.3dm**.

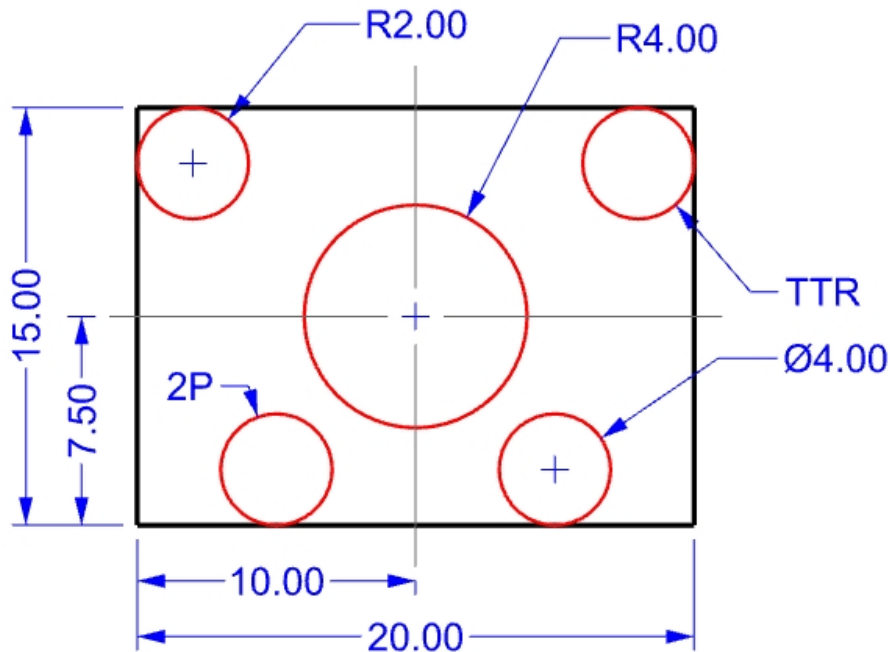

2. On the **Curve** menu, click **Circle**, and then click **Center, Radius**.
3. For the **Center of circle** snap to the intersection of the centerlines.
4. For the **Radius** type **4** and press **Enter**.  
A circle is created around the center line intersection.

### Divide a curve by the number of segments

For the next part of this exercise, we need to find some specific points to locate two of the circles. We will use the **Divide** command to create the points.

1. On the **Curve** menu, click **Point Object**, then click **Divide Curve by**, and then click **Number of segments**.
2. Select the bottom line as the curve to divide, press **Enter**.

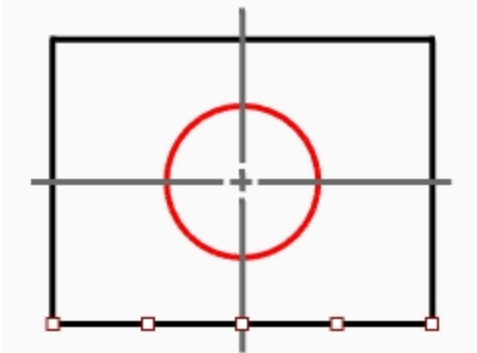

3. For the **Number of segments** type **4** and press **Enter**.  
The line is marked off into four segments with a point at the end of each segment.

### Draw a diameter circle

1. Turn on the **Point** object snap.
2. On the **Curve** menu, click **Circle**, and then click **2 Points**.
3. For the **Start of diameter** pick snap to the second point from the left end of the line you divided.

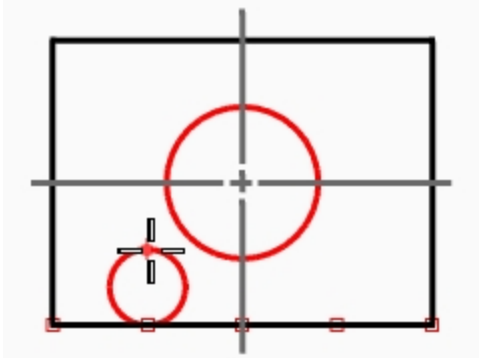

4. For the **End of diameter** type **4** and press **Enter**, then turn Ortho on and pick in the straight up direction. A circle is created with the two points you picked as the diameter, and the diameter was constrained to a value of 4.
5. Repeat these steps for the second diameter circle.

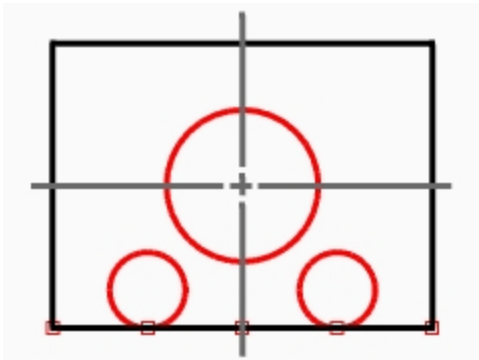

### Draw a tangent, tangent, radius circle

1. On the **Curve** menu, click **Circle**, and then click **Tangent, Tangent, Radius**.
2. For the **First tangent curve**, select the top line.

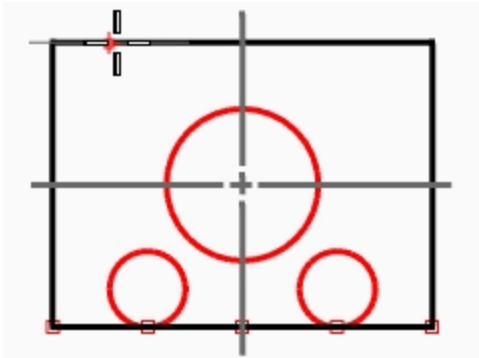

- For the **Second tangent curve**, select the left line.

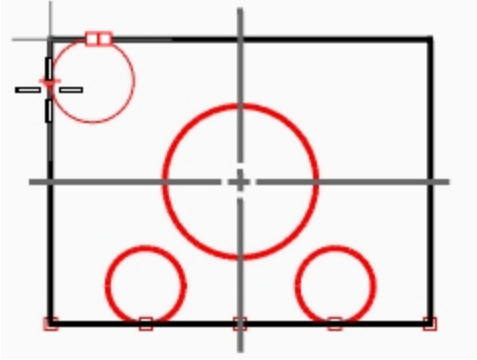

- For the **Radius**, type **2** and press **Enter**.  
A circle is created that is tangent to the two lines you selected with a radius of 2.
- Repeat these steps for the second circle.

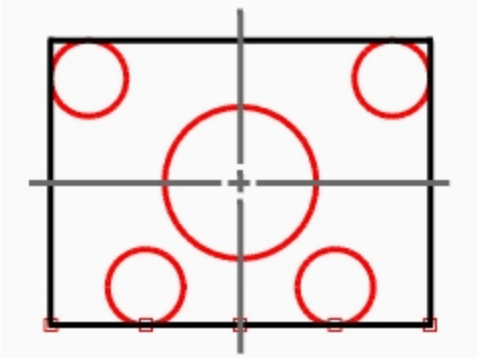

### Use extrusions to make it 3-D

- Select the lines that form the rectangle.
- On the **Solid** menu, click **Extrude Planar Curve**, and then click **Straight**.
- For the **Extrusion Distance**, type **2** and press **Enter**.  
The rectangle generates a box.

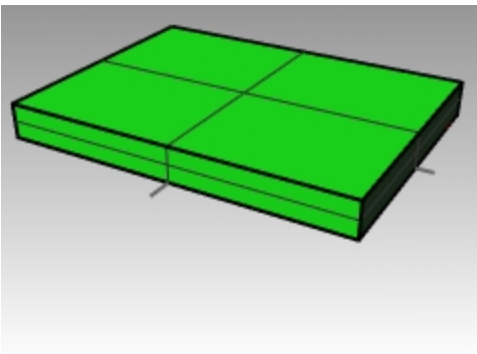

- Select the four smaller circles.
- On the **Solid** menu, click **Extrude Planar Curve**, and then click **Straight**.

6. For the **Extrusion Distance** type, **-6** and press **Enter**.  
The circles generate cylinders.

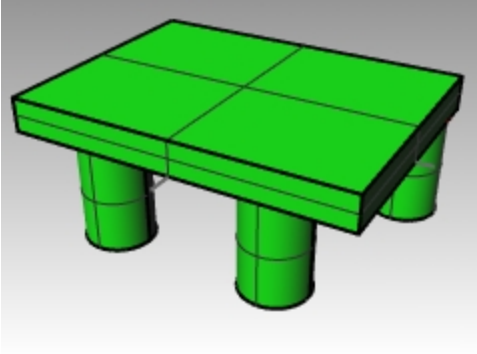

7. Select the large circle in the center.
8. On the **Solid** menu, click **Extrude Planar Curve**, and then click **Straight**.
9. For the **Extrusion Distance**, type **4** and press **Enter**.  
The circle generates a cylinder.

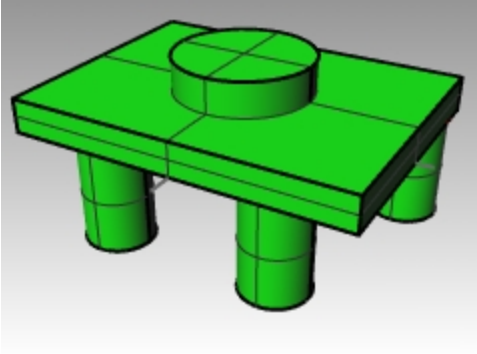

## Exercise 6-10 Use circle commands with object snaps

1. **Open** the model **Link.3dm**.
2. Complete the model as shown.

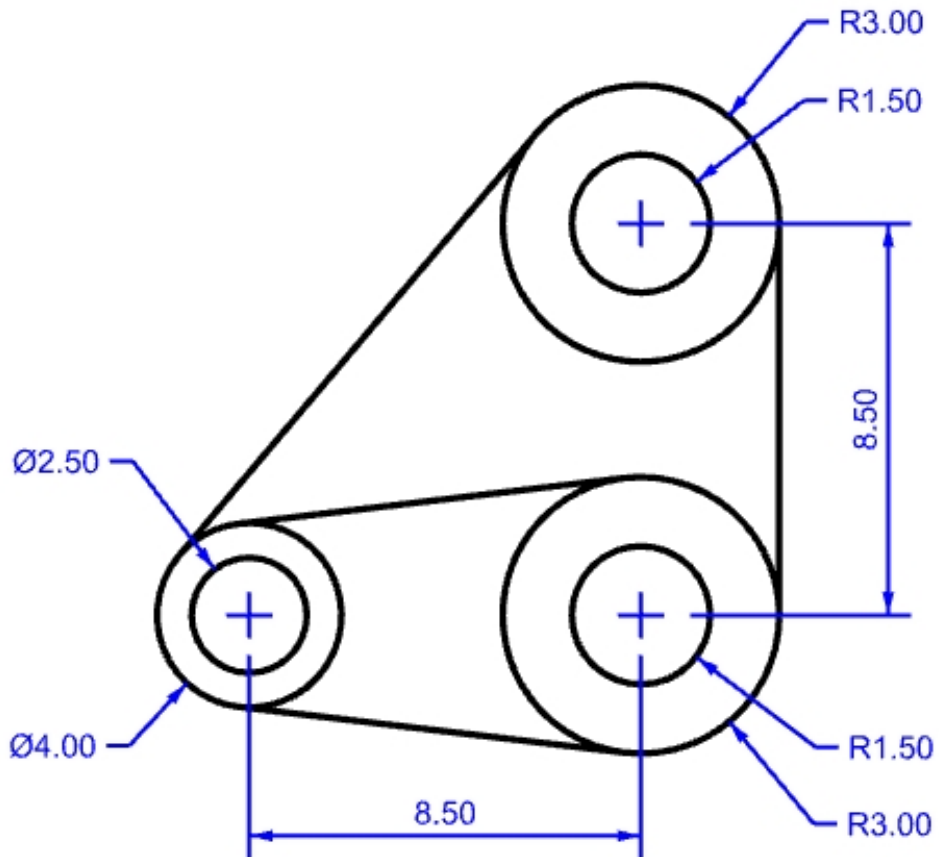

3. Draw the three large circles first.  
Snap to the center line intersections to place the circles.

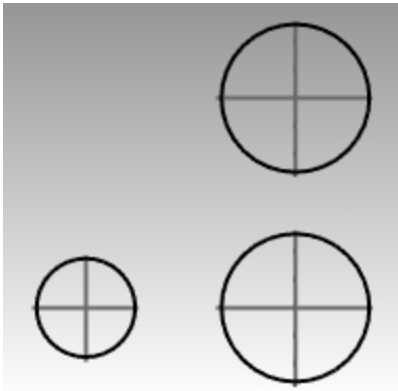

4. Draw the small holes next.  
Use object snaps to snap to the centers of the large circles

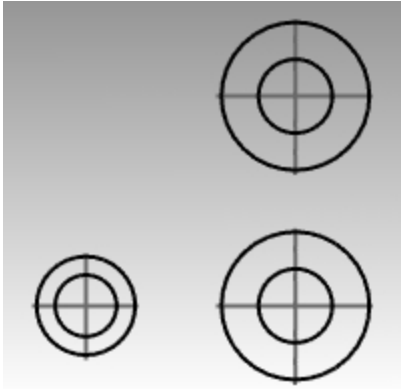

5.

**Optional Approach:** Create the concentric circles in steps 3 & 4 by picking a reasonable size. Do not enter the precise sizes. However, after the circles have been created, set the exact size with the **ModifyRadius** command.

#### Draw the tangent lines

1. On the **Curve** menu, click **Line**, and then click **Tangent to 2 Curves**.
2. For the **First tangent point** pick the edge of one of the circles near where you want the tangent line to attach.

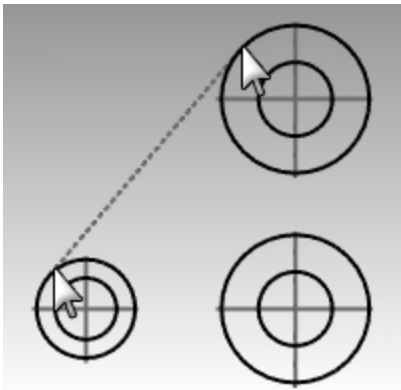

3. For the **Second tangent point** pick the edge of another circle. Rhino will find the tangent points for you.
4. Continue to use this command to complete the model.

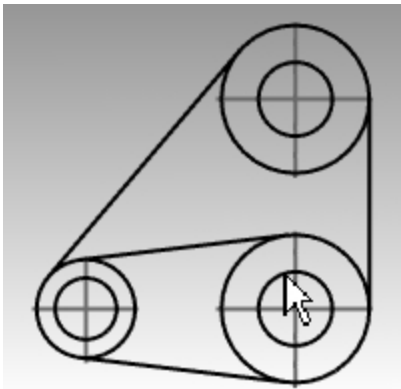

#### Arcs

You can create arcs using various points on the arc and construction geometry.

You can continue an existing curve with an arc to an existing curve, to a point or by an angle.



## Exercise 6-11 Drawing Arcs: CSA, SED, SER

1. Open the model **Arc1.3dm**.

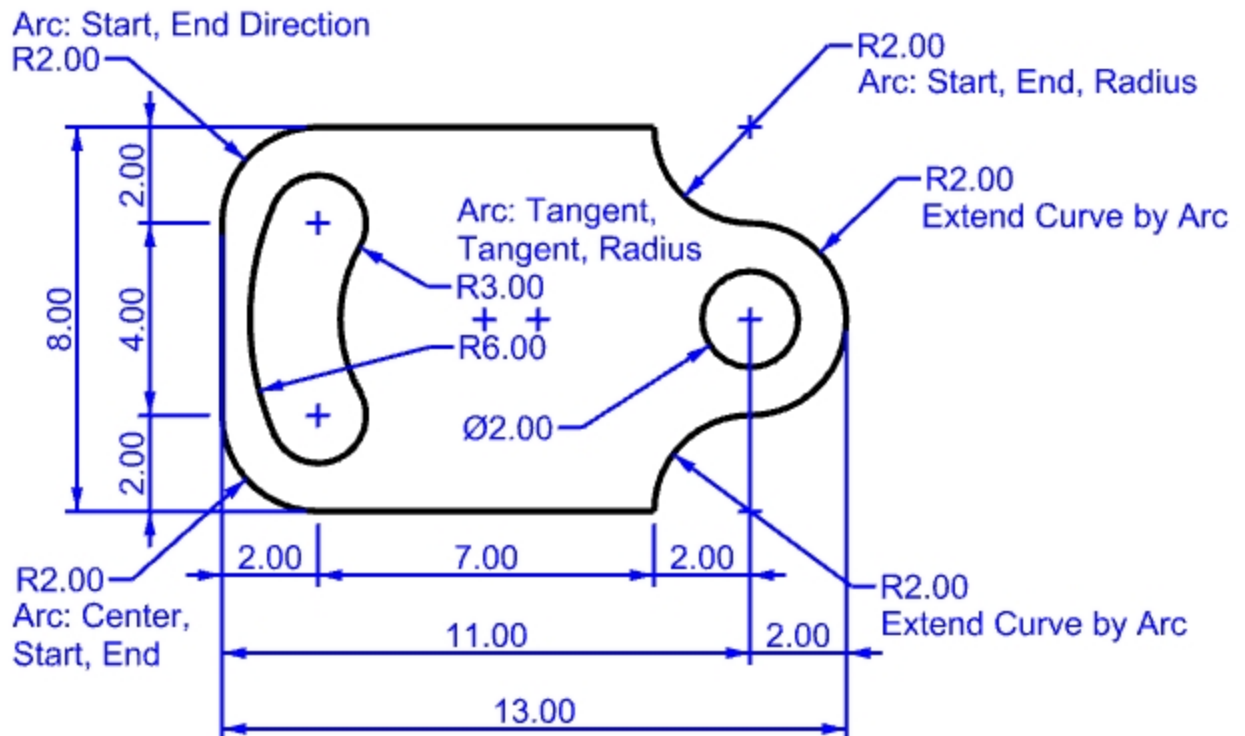

2. On the **Curve** menu, click **Arc**, and then click **Center, Start, Angle**.
3. For the **Center of arc**, snap to the center of the circle at the lower left.
4. For the **Start of arc**, snap to the end of the line.
5. For the **End point or angle**, snap to the end of the other line.

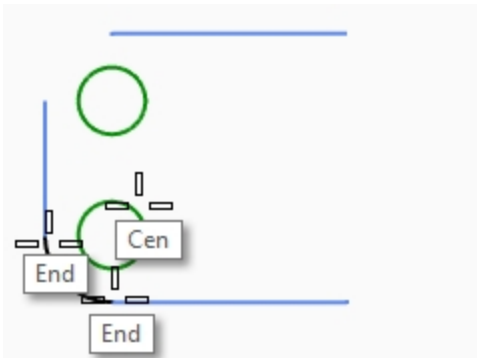

### Draw a start, end, direction arc

1. On the **Curve** menu, click **Arc**, and then click **Start, End, Direction**.
2. For the **Start of arc**, snap to the upper end of the vertical line.
3. For an **End of arc**, snap to the adjacent end of the horizontal line at the top.

4. For the **Direction at start**, toggle **Ortho** on and drag in the straight up direction and pick.

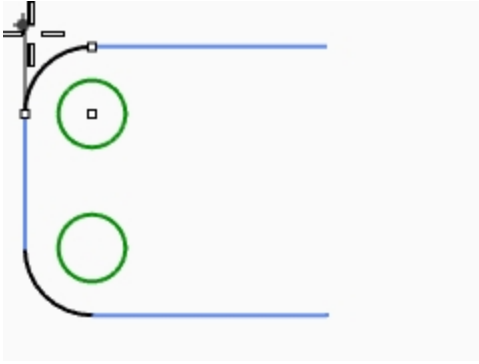

5. Make another **Direction Arc** at the upper right.
6. For the **Start of arc**, snap to the right end of the horizontal line.
7. For an **End of arc**, type **R2,-2** and press **Enter**.
8. For the **Direction at start**, toggle **Ortho** on and drag in the straight down direction and pick..

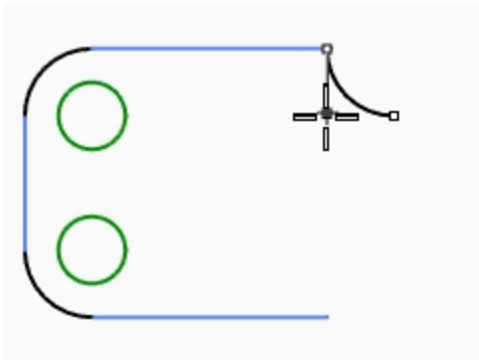

#### Add more arc segments using extension option

1. On the **Curve** menu, click **Arc**, and then click **Center, Start, Angle**.
2. In the command-line, click **Extension**.
3. For the **Select near curve end**, pick near the end of the arc you just made.
4. For the **End of arc**, type **4** and press **Enter**.
5. With **Ortho** on pick a point below the first point.  
The arc will be tangent to the curve you chose.

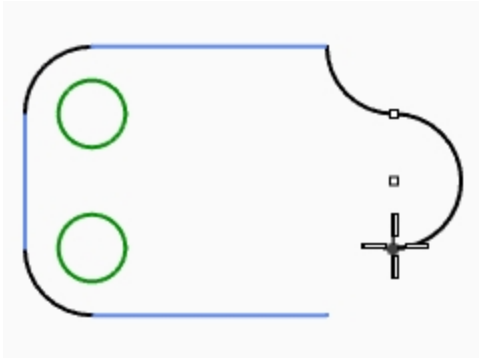

#### Add more arc segments using the extension option

1. On the **Curve** menu, click **Arc**, and then click **Center, Start, Angle**.
2. In the command-line, click **Extension**.
3. For the **Select near curve end**, pick near the end of the arc you just made.

- For the **End of arc**, snap to the end of the horizontal line.

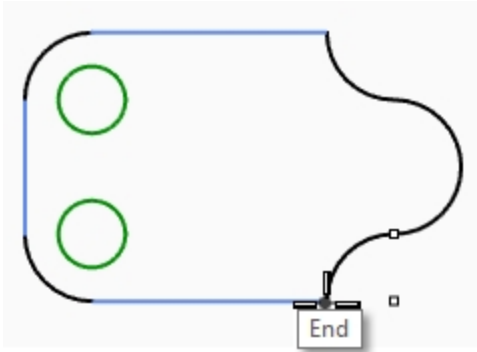

### Draw a tangent, tangent, radius arc

- On the **Curve** menu, click **Arc**, and then click **Tangent, Tangent, Radius**.
- For the **First tangent curve** pick the lower right side of the top circle.
- For the **Radius** type **3** and press **Enter**.
- For the **Second tangent curve** pick the upper right side of the lower circle.
- Move your cursor and pick when the correct arc is displayed.

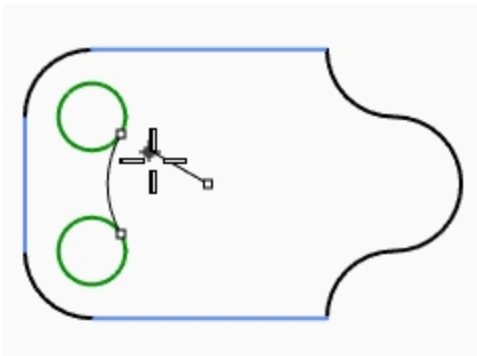

- On the **Curve** menu, click **Arc**, and then click **Tangent, Tangent, Radius**.
- For the **First tangent curve** pick the upper left side of the top circle.
- For the **Radius** type **6** and press **Enter**.
- For the **Second tangent curve** pick the lower left side of the lower circle.
- Move your cursor and pick when the correct arc is displayed.

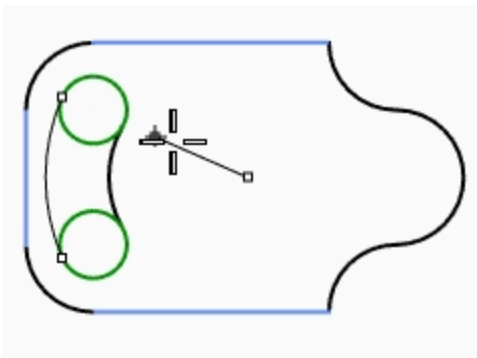

### Make it solid

First you will have to trim the two small circles, then you can extrude the remaining curves.

- Select the two arcs you just completed.
- On the **Edit** menu, click **Trim**.
- For the **Objects to trim**, pick the inner edge of each small circle.  
You will be left with a slot.

- Use the **Circle** command to draw the circle concentric to the arc on the right.

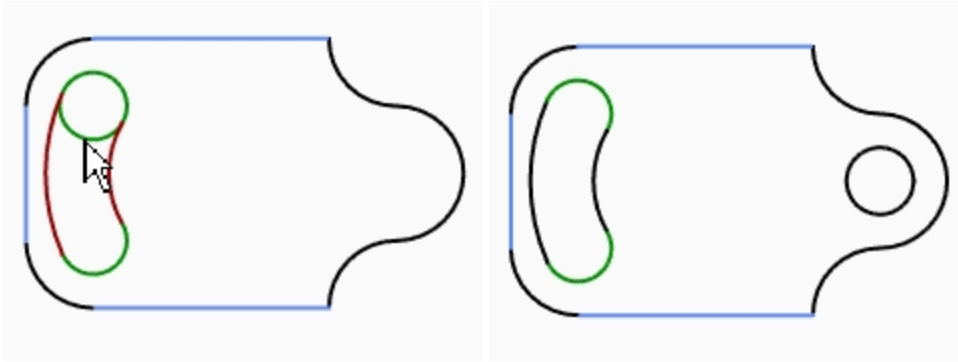

- Select all the curves.
- On the **Solid** menu, click **Extrude Planar Curve**, and then click **Straight**.
- For the **Extrusion distance**, type **1** and press **Enter**.  
The curves have been extruded and capped.

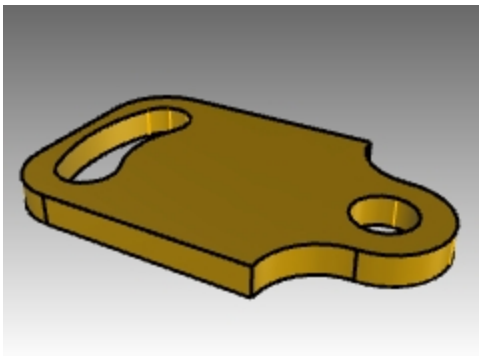

### Practice drawing arcs

It might be helpful to start this model by drawing centerlines first and then lock them or put them on a locked layer. Use the **Line** command to construct the centerlines. When you have the centerlines drawn, you can use their intersection points to draw your arcs and circles.

## Exercise 6-12 The Mechanical Arm

- Start a new model, use the **Small Objects - Inches.3dm** template.
- Save as **Arc2**.
- Rename layers that are already in the template as follows:

<u>Layer Name</u>	<u>New Name</u>
Layer 01	Center
Layer 02	Object Lines
Layer 03	Dimensions
Layer 04	Text

Create this model using object snaps and the **Line**, **Circle**, and **Arc** commands.

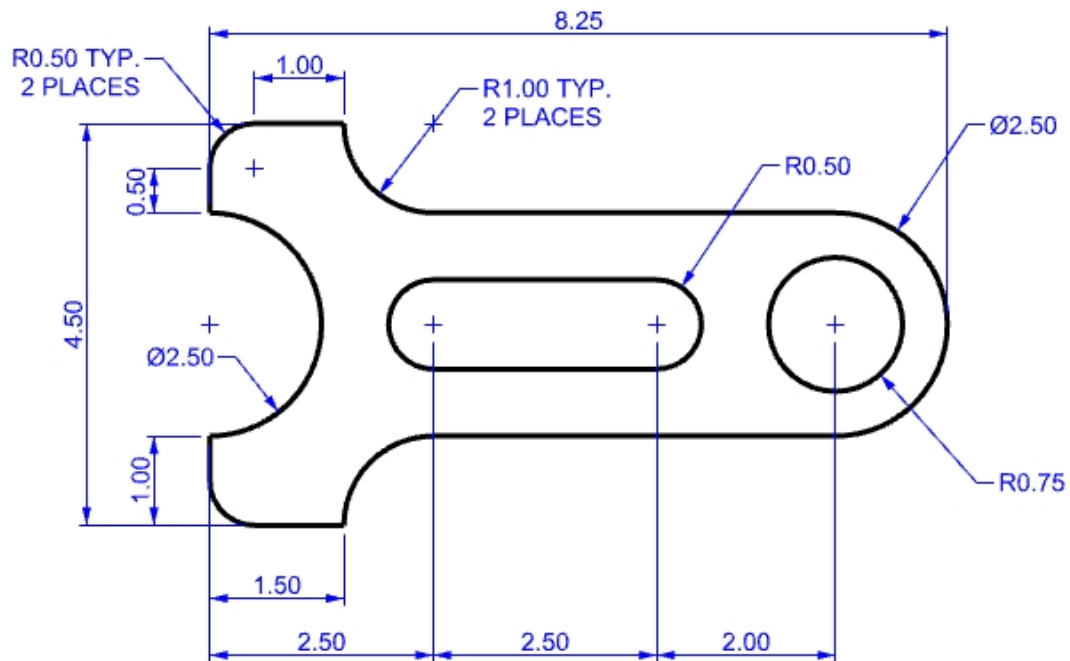

## Modeling Skills to Consider

- Start by making the horizontal and vertical construction lines with the use of the **Offset** command.
- Draw lines and arcs with the *Intersection* osnap referencing the construction lines.
- Recommended arcs: Center Start Angle, Center Start End, Start End Radius
- **DrawOrder** commands like **BringToFront** and **SendToBack** will keep the object geometry in front of the construction lines.

### Make it solid

1. Type **SelClosedCrv**. All the curves should be selected.  
If not, then figure out where the curve is open with **CrvEnd** and close the curve with the **CloseCrv** commands.
2. On the **Solid** menu, click **Extrude Planar Curve**, and then click **Straight**.
3. For the **Extrusion distance**, type **1** and press **Enter**.
4. The curves have been extruded and capped.

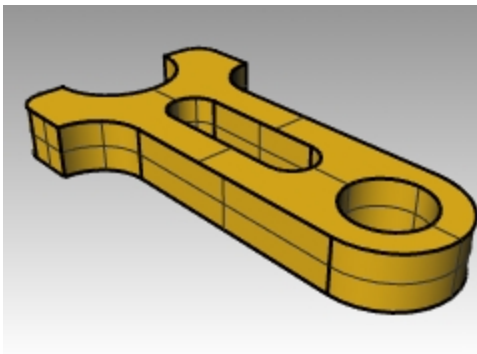

## Ellipses and polygons

You can draw ellipses from the center or by the ends. You can draw polygons from a center point or an edge. You can draw a rectangle from diagonal corners or by choosing three points.

### Exercise 6-13 The Toy Table

1. Start a new model, use the **Small Objects - Millimeters.3dm** template.
2. Save as **Toy**.

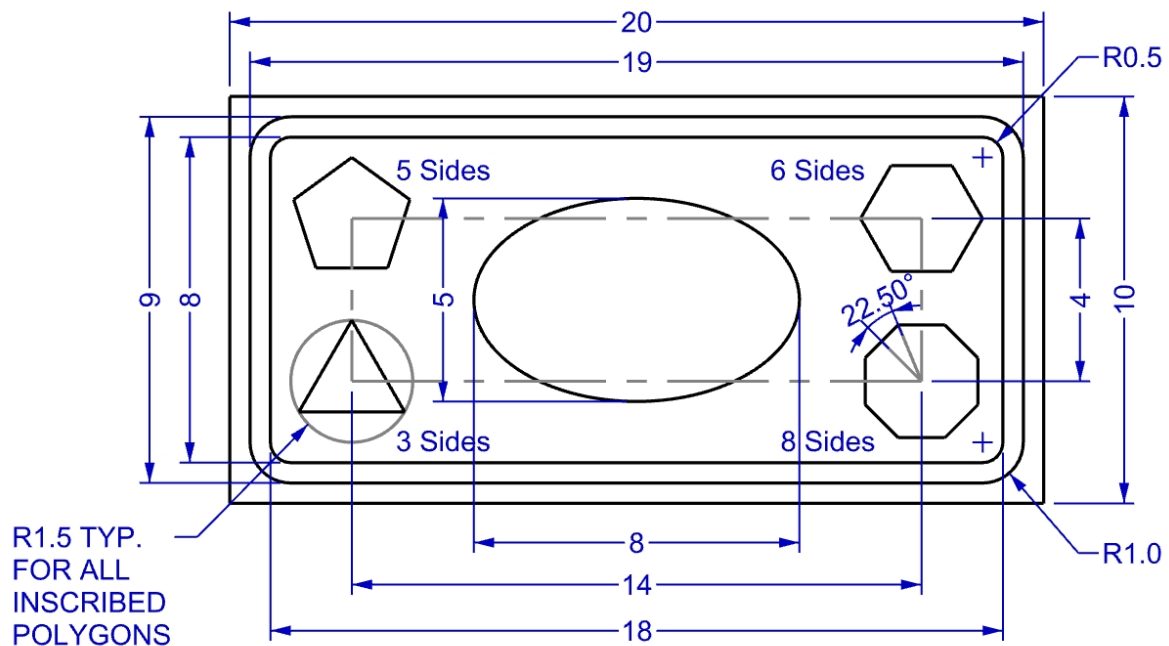

3. On the **Curve** menu, click **Rectangle**, and then click **Corner to Corner**.
4. For the **First Corner**, type **-10,-5** and press **Enter**.
5. For the **Length**, type **20** and press **Enter**.
6. For the **Width**, type **10** and press **Enter**.

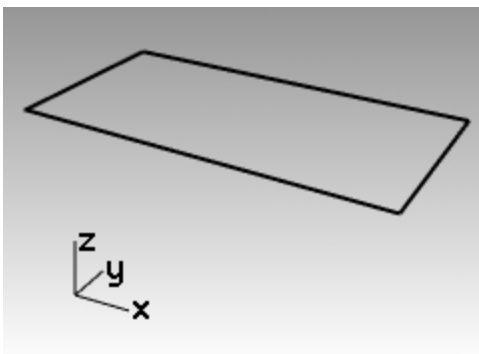

#### Draw rectangles from a center point with rounded corners

1. On the **Curve** menu, click **Rectangle**, and then click **Center, Corner**.
2. Type **R**, and press **Enter** to give the rectangle rounded corners.
3. For the **Center of rectangle**, type **0** and press **Enter**.
4. For the **Length**, type **19**, and press **Enter**.
5. For the **Width**, type **9**, and press **Enter**.
6. For the **Radius**, type **1**, and press **Enter**.

If you are creating a rounded rectangle, you can choose to select a point in the corner to set its curvature instead of typing a radius value.

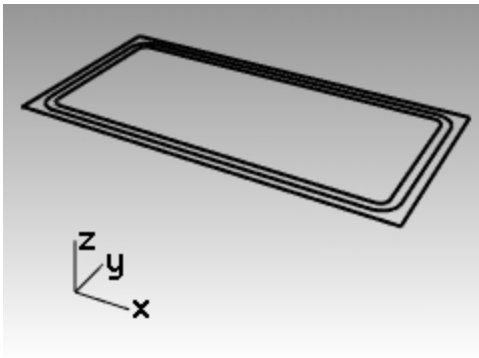

To change the type of corner, click **Corner** in the command-line to toggle from circular rounded corners to conic rounded corners.

7. Repeat these steps for a second rounded rectangle with a length of **18** and a width of **8** with **0.5** radius corners.

#### Draw an ellipse from its center and axis ends

1. On the **Curve** menu, click **Ellipse**, and then click **From Center**.
2. For the **Ellipse center**, type **0**, and press **Enter**.
3. For the **End of first axis**, type **4**, and press **Enter**.
4. Hold the **Shift** key to toggle the **Ortho** on and pick to the right.
5. For the **End of second axis**, type **2.5**, and press **Enter**.
6. Pick a point vertical.

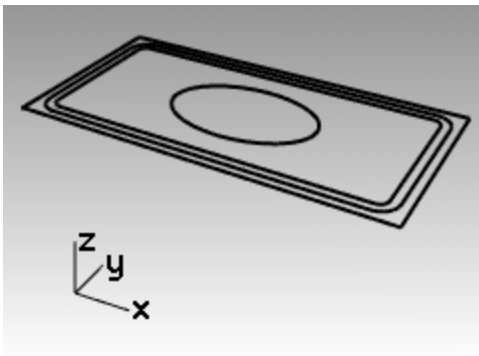

#### Draw a rectangle to locate the polygon centers

1. On the **Curve** menu, click **Rectangle**, and then click **Center, Corner**.
2. For the **Center of rectangle**, type **0** and press **Enter**.
3. For the **Length**, type **14**, and press **Enter**.
4. For the **Width**, type **4**, and press **Enter**.

If you are creating a rounded rectangle, you can choose to select a point in the corner to set its curvature instead of typing a radius value.

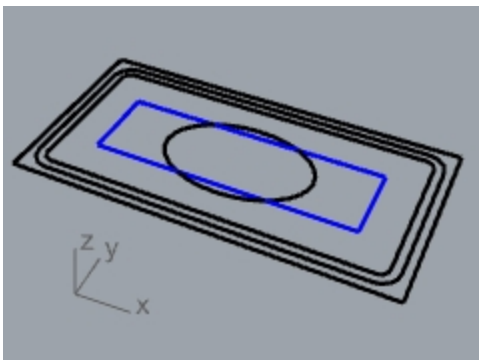

### Draw the 5-sided polygon from its center and radius

---

1. On the **Curve** menu, click **Polygon**, and then click **Center, Radius**.
2. Click **NumSides** in the command-line, type **5**, and press **Enter** to change the number of sides for the polygon.
3. For the **Center**, pick in the upper left of the 14x4 rectangle to locate the center point for the polygon.
4. For the **Corner**, type **1.5**, and press **Enter**.
5. Pick a point to orient the polygon.

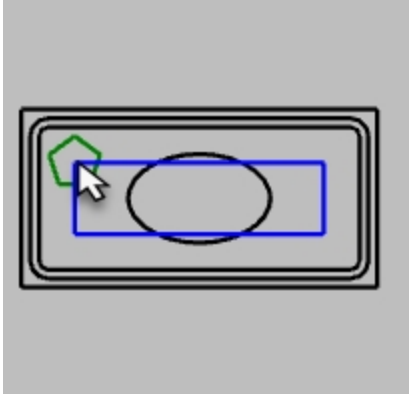

### Draw the 3-sided polygon from its center and radius

---

1. On the **Curve** menu, click **Polygon**, and then click **Center, Radius**.
2. Click **NumSides** in the command-line, type 3, and press **Enter** to change the number of sides for the polygon.
3. For the **Center**, pick in the lower left of the 14x4 rectangle to locate the center point for the polygon.
4. For the **Corner**, type **1.5**, and press **Enter**.
5. Pick a point to orient the polygon.

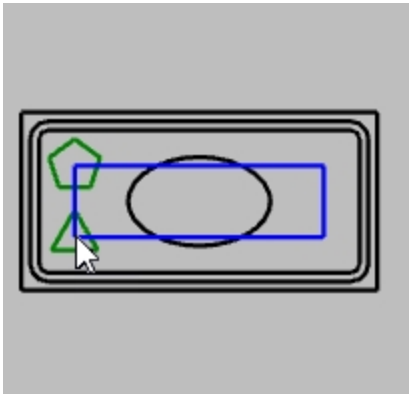

### Draw the 6-sided polygon from its center and radius

---

1. On the **Curve** menu, click **Polygon**, and then click **Center, Radius**.
2. Click **NumSides** in the command-line, type **6**, and press **Enter** to change the number of sides for the polygon.
3. For the **Center**, pick in the upper right of the 14x4 rectangle to locate the center point for the polygon.



4. For the **Corner**, type **1.5**, and press **Enter**.
5. Pick a point to orient the polygon.

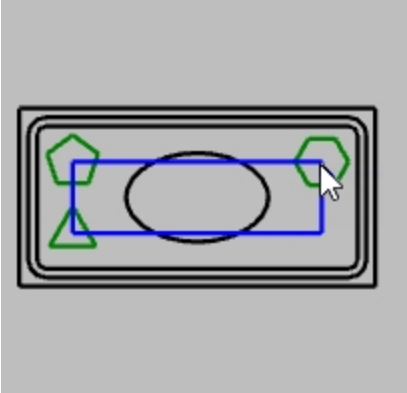

#### Draw the 8-sided polygon from its center and radius

1. On the **Curve** menu, click **Polygon**, and then click **Center, Radius**.
2. Click **NumSides** in the command-line, type **8**, and press **Enter** to change the number of sides for the polygon.
3. For the **Center**, pick in the lower right of the 14x4 rectangle to locate the center point for the polygon.
4. For the **Corner**, type **1.5**, and press **Enter**.

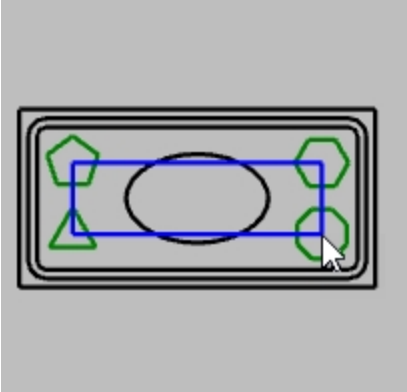

5. To set the angle, type **<22.5** and move the mouse to **Pick** the proper orientation. This will orient the top and bottom edges of the octagon to horizontal.

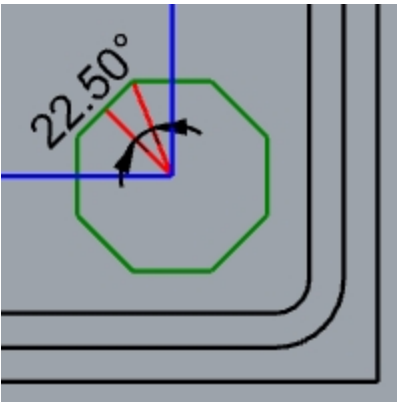

#### Make the rounded rectangles solid

1. Select the larger and the smaller rounded rectangle.
2. On the **Solid** menu, click **Extrude Planar Curve**, and then click **Straight**.
3. Drag both down to set the thickness and click or type a value for the thickness.  
Use a negative number to extrude down.

The two rounded rectangles are coplanar or in the same plane. Because of this the smaller rounded rectangle is

removed from the larger one, and the difference is extruded.

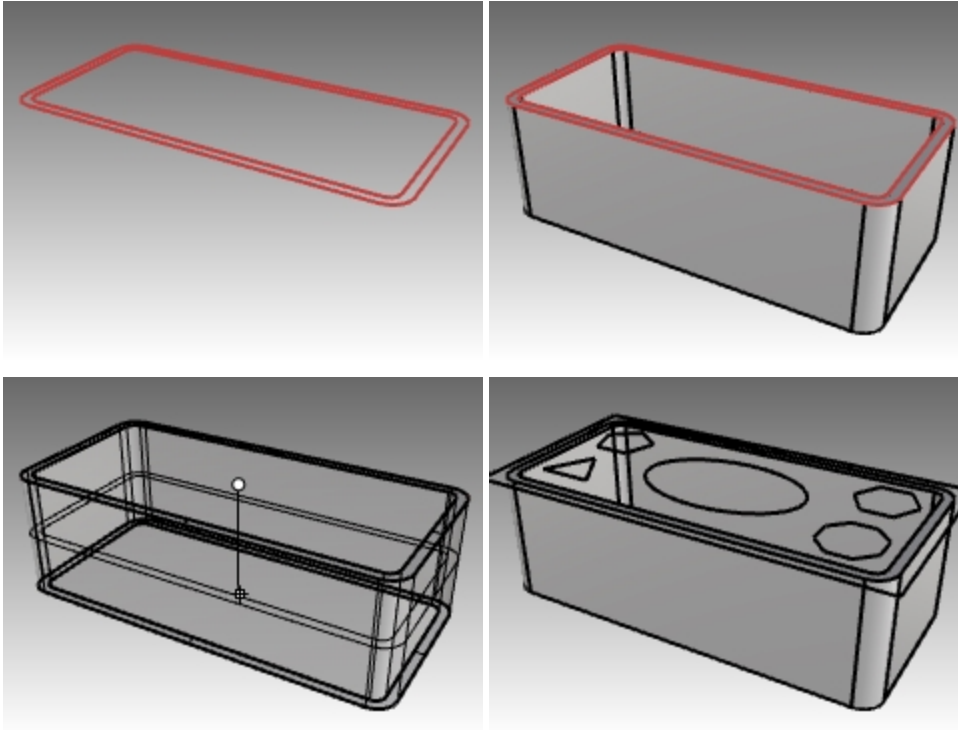

---

#### Make the rectangle solid

1. Select the rectangle.
2. On the **Solid** menu, click **Extrude Planar Curve**, and then click **Straight**.
3. Set the **Bothsides** option to **No**.
4. Drag it up to set the thickness and click.

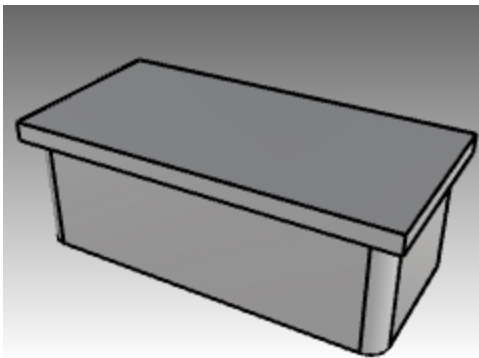

---

#### Make the ellipse solid

1. Select the ellipse.
2. On the **Solid** menu, click **Extrude Planar Curve**, and then click **Straight**.
3. Set the **Bothsides** option to **Yes**.

- Pick to set the thickness.  
Make sure the thickness is enough to protrude through both sides of the rectangular solid.

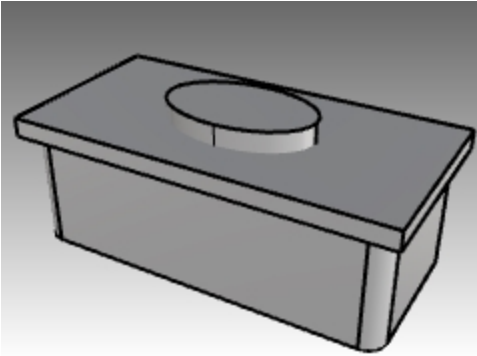

---

#### Cut the ellipse solid from the rectangle

- Select the solid rectangle.
- On the **Solid** menu, click **Difference**.
- Select the solid ellipse, and press **Enter**.

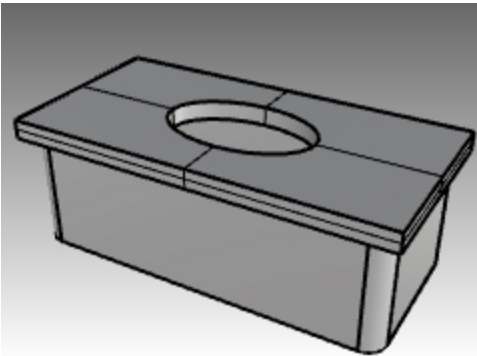

- Select the solid rectangle and solid extrusion base.
- On the **Solid** menu, click **Union**.

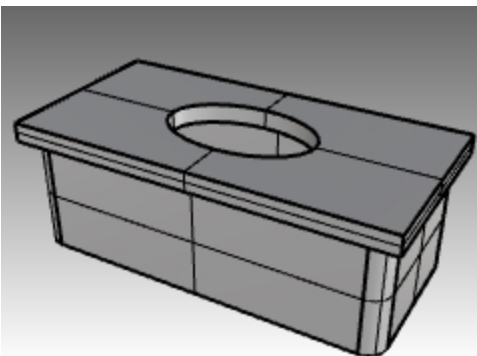

## Extrude the polygons

---

1. Select the polygons.
2. On the **Solid** menu, click **Extrude Planar Curve**, and then click **Straight**.
3. Pick to set the thickness.

Make sure the thickness is enough to protrude through both sides of the rectangular solid.

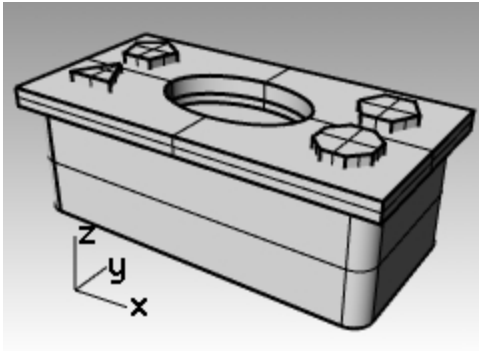

## Cut holes with the solid polygons

---

1. Select the rectangular solid.
2. On the **Solid** menu, click **Difference**.
3. In the command-line, set **DeleteInput=No**.
4. For the second set of surfaces or polysurfaces, select the solid polygons, and press **Enter**.  
Holes will be cut, but the objects will remain.

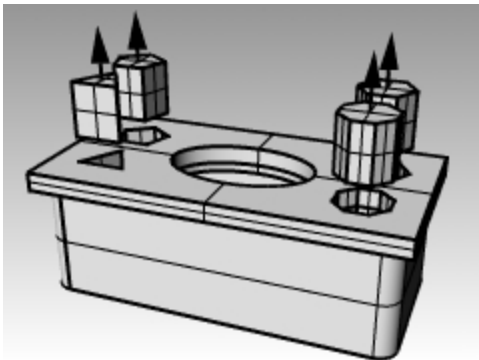

## Free-form curves

The use of free-form curves allows more flexibility to create complex shapes.

### Exercise 6-14 Practice drawing curves

---

1. **Open** the model **Curve.3dm**.  
In this exercise, you will learn how to make a curve by control points, an interpolated curve, and a conic curve to compare the differences between the three methods.  
A common method for creating free-form curves is to draw lines that are accurately measured. Use these lines as guidelines. Another method for creating free-form curves is to use a background image made from a sketch or a photograph. In this exercise the guidelines have been created for one of the exercises and an image has been included for the other exercise.
2. In the **Osnap** toolbar, check **End** and **Near**, clear all others.  
**Hint:** If you click **End** with your right mouse, it will clear all the others.
3. Toggle **Ortho** and **Grid Snap** off.

#### Draw a curve by control points

---

Control points define the curvature of the curve, but the points are usually not on the curve.

1. On the **Curve** menu, click **Free-form**, and then click **Control Points**.
2. For the **Start of Curve**, snap to the end point of the polyline guideline.
3. For the **Next point**, snap on the polyline guideline using the **Near** object snap.
4. Continue to snap to the guideline until you get to the end.
5. Press **Enter**.

A free-form curve is drawn. The control points, while on the guideline, were not on the curve itself except at the two ends.

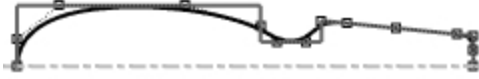

### Draw a curve interpolate through points

1. Change to the **Interpolated Curve** layer.
2. On the **Curve** menu, click **Free-form**, and then click **Interpolate Points**.
3. For the **Start of Curve**, snap to the intersection of the center line and the image using the **Near** object snap.
4. For the **Next point**, continue to pick points along the edge of the image until you get to the other end, then use the **Near** object snap to snap to the intersection of the center line and the image.
5. Press **Enter**.

A free-form curve is created from specified interpolate points. These points lie on the curve and determine its curvature.

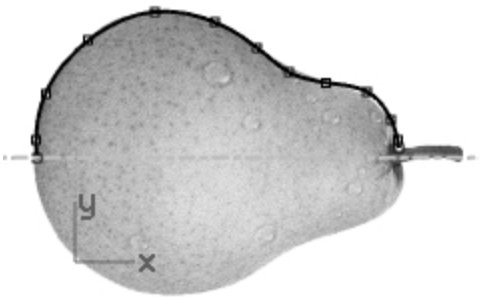

### Draw a conic curve

1. Change to the **Conic** layer.
2. On the **Curve** menu, click **Conic**.
3. For the **Start of conic**, snap to the point (1) at the lower left.
4. For the **End of conic**, snap to the point (2) above and to the right from the previous point.
5. For the **Apex**, snap to the point (3) in between the previous points.
6. For the **Curvature point or rho**, pick a point for the desired curvature.

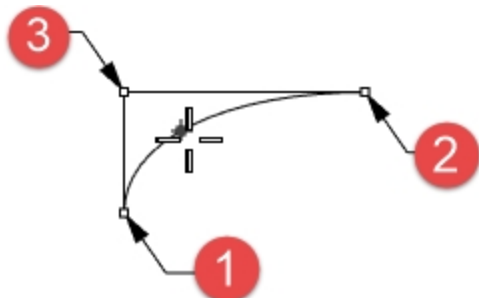

### Make the curve into a surface

1. Select the control point curve.
2. On the **Surface** menu, click **Revolve**.
3. For the **Start of revolve axis**, snap either end of the curve.

- For the **End of revolve axis**, snap to the other end of the curve.

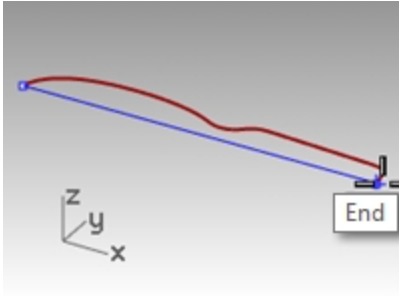

- For the **Start angle**, click **FullCircle**.

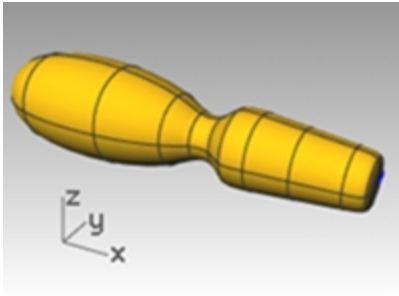

- Repeat steps 2-5 for the interpolated curve.

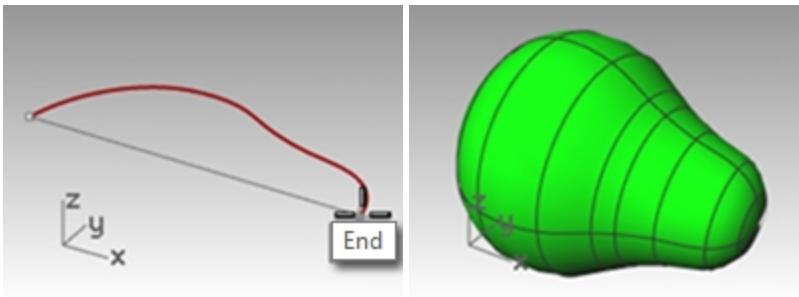

## Helix and Spiral

Now you make some special curves with the **Helix** and **Spiral** commands. These curves can become surfaces or solids with the **Pipe** command. Also Helix option **AroundCurve** can be used to create a Helix around a curve, similar to a coiled cord.

### Exercise 6-15 Helix and spiral curves

#### Open the model

- Open** the model **Helix-Spiral.3dm**.
- In the **Osnap** toolbar, check **End** and **Point**, clear all others.  
Click **End** with your right mouse, to clear all the others.
- Toggle **Ortho** and **Grid Snap** off.

#### Draw a helix

- Change to the **Helix** layer.
- On the **Curve** menu, click **Helix**.
- For the **Start of axis**, in the **Perspective** viewport, snap to the end of the vertical line (1).
- For the **End of axis**, in the **Perspective** viewport, snap to the end of the vertical line (2).
- Click **Mode** in the command-line until it is set to **Mode=Turns**.
- Click **Turns** in the command-line.

- For the **Number of turns**, type **10**, and press **Enter**.

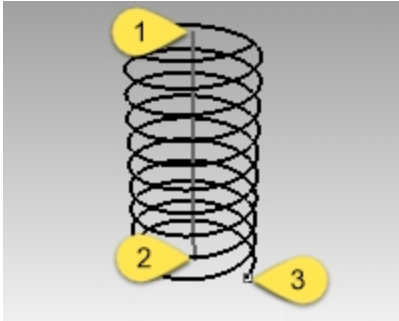

- Pick the point (3) to the right of the axis line.  
A helix with 10 turns and a radius of 20 is created.

### Draw a spiral

- Make the **Spiral** layer current.
- On the **Curve** menu, click **Spiral**.
- For the **Start of axis**, in the **Perspective** viewport, snap to the end of the other vertical line (1).
- For the **End of axis**, snap to the other end of the same line (2).
- Click **Mode** in the command-line until it is set to **Mode=Pitch**.
- in the command-line, click **Pitch**.
- For the **Pitch**, type **15** and press **Enter**.
- In the command-line, click **ReverseTwist** to set it to **Reverse Twist=Yes**.

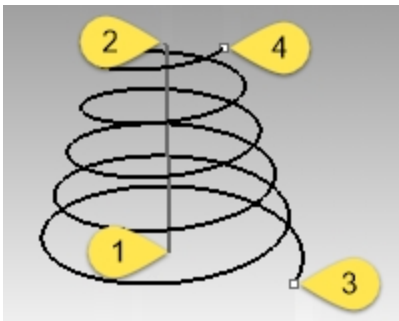

- For the **First radius and start point**, snap the point (3).
- For the **Second radius**, snap to the other point (4).  
A spiral is created with a reverse twist and the distance between each turn is 15.

### Draw a helix around a curve

- Make the **HelixAlongCurve** layer current.
- On the **Curve** menu, click **Helix**.
- In the command-line, click **AroundCurve**.
- Select the free-form curve.
- Click **Mode=Turns**.
- Click **Turns**.
- Type **25**, and press **Enter**.
- Click **ReverseTwist=No**.

9. For the **Radius**, type **5**, and press **Enter**.



10. For the **Start point**, pick a point .  
A helix is created around the curve.
11. Undo this helix.

### Draw a helix around a curve with History

---

1. On the **Status Bar**, click **Record History** to turn history on for this command.
2. On the **Curve** menu, click **Helix**.
3. In the command-line, click **AroundCurve**.
4. Select the free-form curve.
5. Click **Mode=Turns**.
6. Click **Turns**.
7. Type **25**, and press **Enter**.
8. Click **ReverseTwist=No**.



9. For the **Radius**, type **5**, and press **Enter**.
10. For the **Start point**, pick a point .  
A helix is created around the curve.



## Edit the input curve

1. Select the free-form curve.
2. Type **PointsOn** **F10**.
3. Pick a few control points and pull the curve into a new shape.

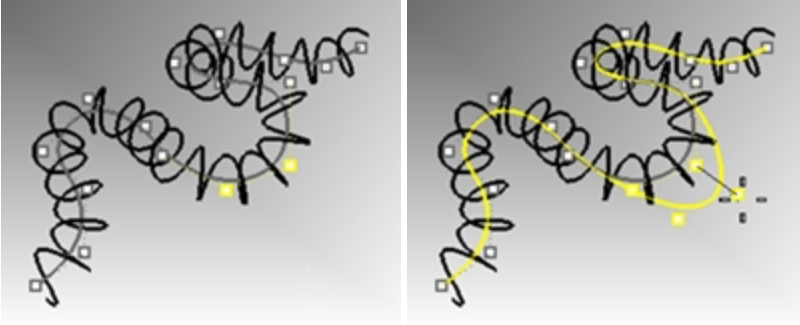

4. Helix will update automatically to the new shape for the free-form curve.

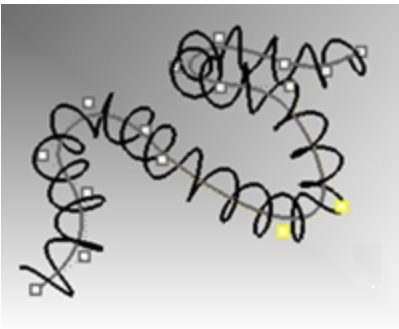

Note: Helix with the **AroundCurve** and **Pipe** commands support History.

## Draw free-form curves

The use of free-form curves allows more flexibility to create complex shapes. In the following exercise we will draw the guidelines and free-form curves for a toy screwdriver.

### Exercise 6-16 The Toy Screwdriver

1. Start a new model, use the **Small Objects - Millimeters.3dm** template.
2. Save as **Screwdriver**.
3. Create **Construction** and **Curve** layers.  
Make them different colors.

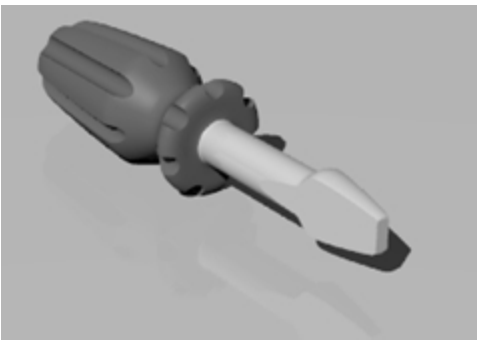

### Create the construction lines

1. Make the **Construction** layer current.
2. In the **Top** viewport, draw a **Polyline** using these dimensions for the guideline.  
A good starting point for the Polyline would be -70,0.

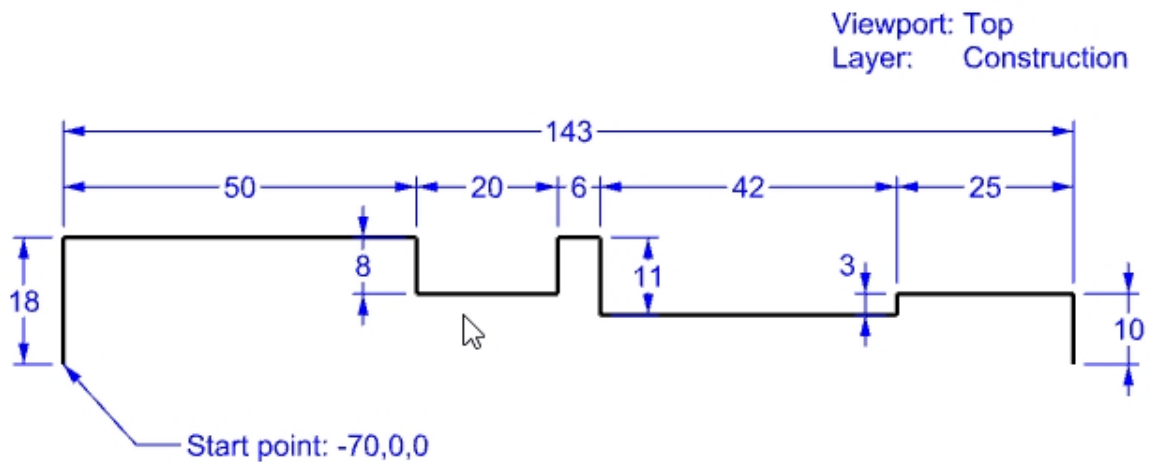

### Create the curve by control points

1. Make the **Curve** layer current.
2. Use the **Curve** command to draw the shape for the toy screwdriver.

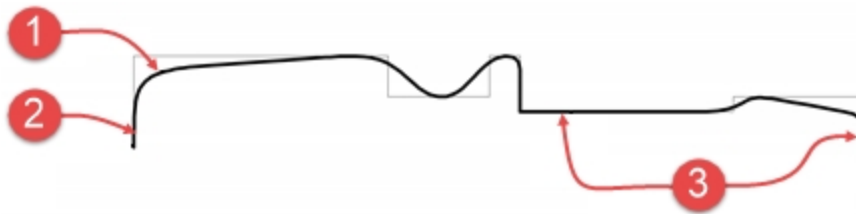

Notes about the drawing

- (1) Curve from control points.
  - (2) Two points in a row (ortho) will give you a tangent at the endpoint.
  - (3) Three or more points in a row (ortho) will allow you to make a portion of the control point curve straight.
3. **Save** your model.

### Make it solid

1. Toggle **Grid Snap** and **Ortho** on.
2. Select the curve.
3. On the **Surface** menu, click **Revolve**.
4. For the **Start of revolve axis**, snap to the end of the curve.
5. For the **End of revolve axis**, snap to the other end of the curve.
6. For the **Start angle**, in the command-line, click **FullCircle**.

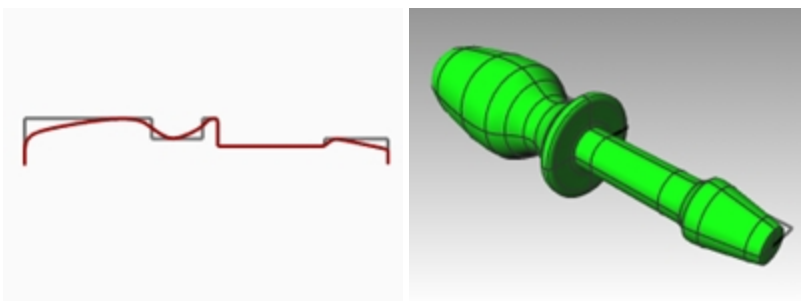

**Add details on your own**

Since we haven't discussed many of the commands that you need to complete this model, use the **Command Help** panel for assistance. Following is a list of procedures for one method to finish the model.

1. In the **Top** viewport, on the **Curve** menu, click **Line**, and then click **Single Line**.
2. Draw a line that will be used to slice the flat part from the screwdriver blade.

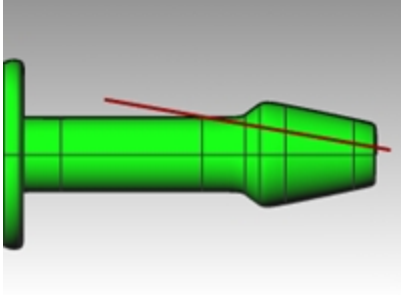

3. Select the line.

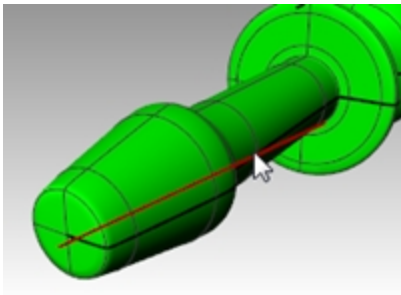

4. On the **Solid** menu, click **Solid Editing Tools**, and then click **Wirecut**.
5. For the **Select objects to cut**, choose the screwdriver, and press **Enter**.

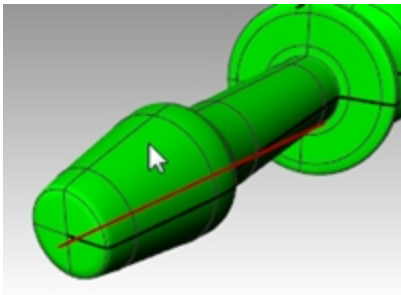

6. For the **First cut depth point**, press **Enter**.
7. For the **Part to cut away**, choose the part you want to remove, and press **Enter**.

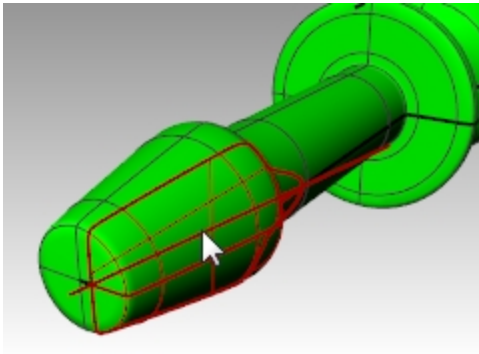

**Mirror the construction line**

1. In the **Top** viewport, on the **Transform** menu, click **Mirror**.  
Use osnaps to precisely mirror the line to the other side of the screwdriver.
2. Repeat steps 3-6 to complete the other side of the blade.

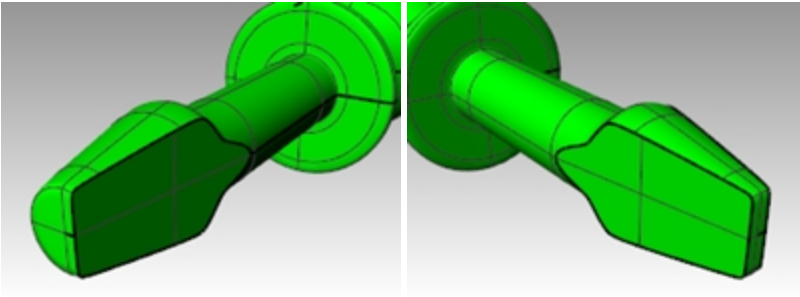

3. In the **Front** viewport, draw a **Curve** along the top of the handle to be used for cutting grooves.  
Drawing the curve in the **Front** viewport, eliminates problems that might arise from having one of the slots along the seam of the surface.

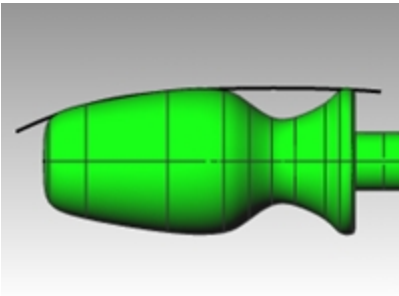

4. Use the **Pipe** command (*Solid menu > Pipe*) to make a pipe surface on the curve.

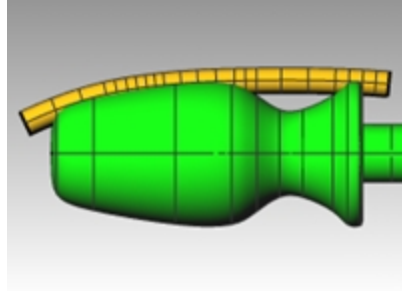

5. Use the **ArrayPolar** command (*Transform menu > Array > Polar*) to make copies of the pipe around the handle.

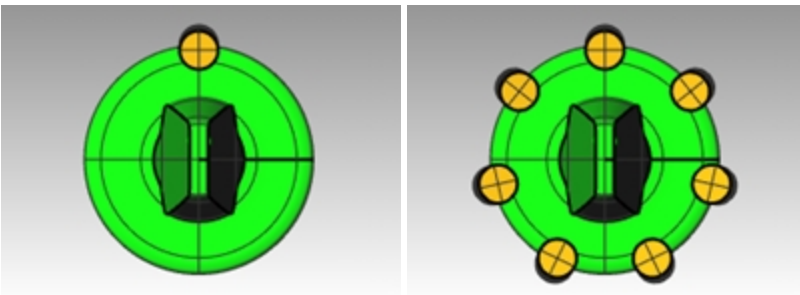

6. Use the **BooleanDifference** command (*Solid menu > Difference*) to remove the pipes from the handle.

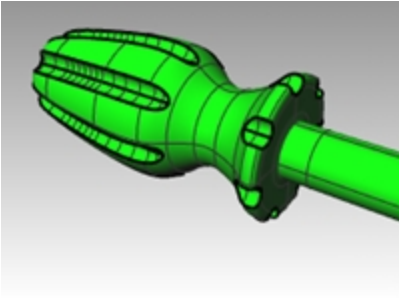

7. Try using the **Render** command (*Render menu > Render*) to make a rendering of the finished screwdriver.

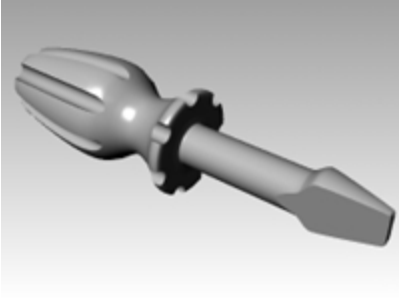



# Chapter 7 - Editing geometry

---

Once you create objects, you can move and edit them to produce complex and detailed variations.

## Fillet

Fillet connects two lines, arcs, circles, or curves extending or trimming them to touch or to join with a circular arc.

Rules to follow when filleting curves:

- The curves must be coplanar.
- The created fillet is determined by picking on the curve portion to keep.
- The radius cannot be so large that it runs past the end of the curve.

## Exercise 7-1 Filleting curves

---

### Connect lines that intersect

---

1. **Open** the model **Fillet.3dm**.

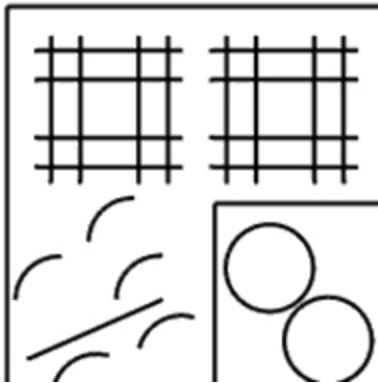

2. On the **Curve** menu, click **Connect Curves**.

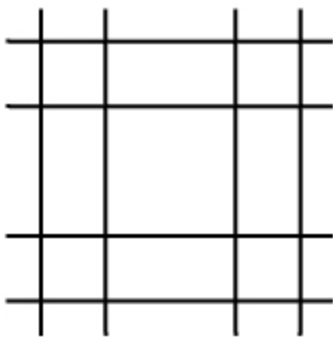

3. For the first curve, select an outer vertical line.

4. For the second curve, select an adjacent horizontal line.  
The ends of the lines are trimmed to a corner.

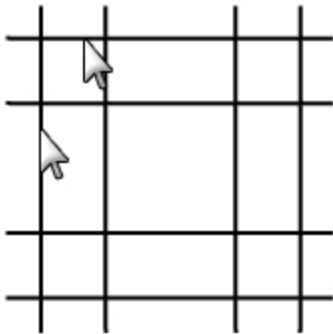

5. Press **Enter** to repeat the command.
6. Connect the other corners, as shown.  
Remember to select the part of the line that you want to keep.

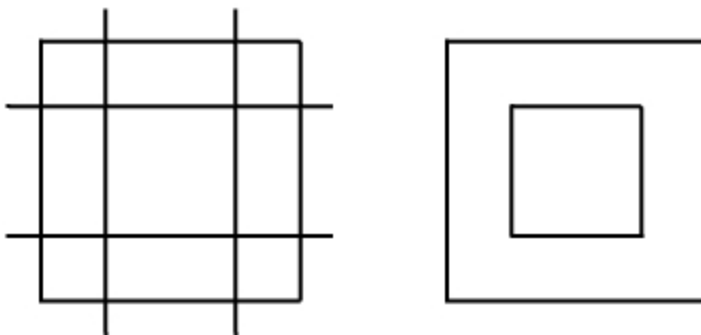

### Join the connected objects

---

1. Select the lines you just connected.
2. On the **Edit** menu, click **Join**.  
The objects are joined together. Curves join only if they touch.

### Fillet lines using an arc

---

1. On the **Curve** menu, click **Fillet Curves**.
2. To change the radius, type **2**, and press **Enter**.
3. In the Command line, set the **Join** option to **Yes**.  
This option joins the curves as they are filleted.
4. Select an outer vertical line.
5. Select an adjacent horizontal line.  
The ends of the lines are trimmed to a radius.



6. Press **Enter** to repeat the command.
7. Fillet the other corners as shown.

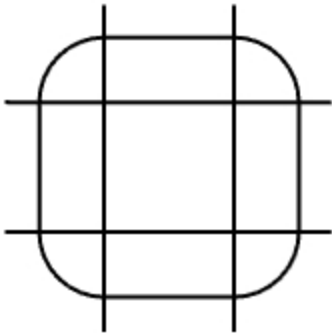

### Fillet the inner lines

1. Press **Enter** to repeat the command.
2. Set the radius to **1**, and press **Enter**.  
This radius will be used for the smaller object.
3. Select an inner vertical line.
4. Select an adjacent horizontal line.
5. Fillet the other corners as shown.

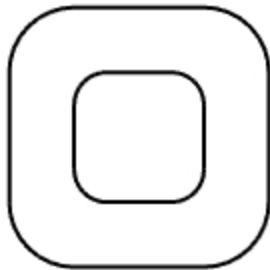

### Fillet circles

1. On the **Curve** menu, click **Fillet Curves**.
2. To set the radius, type **3**, and press **Enter**.
3. Select the right edge of a circle.
4. Select the right edge of the other circle.

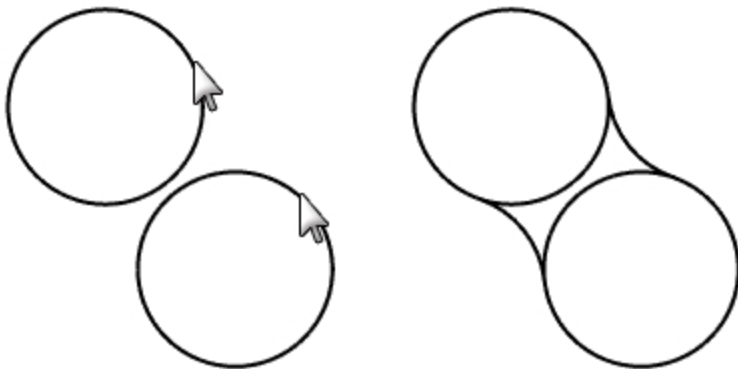

- Repeat the command for the left side of the circles.

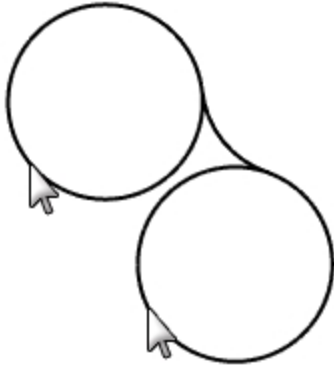

- Select the two fillets you just created.

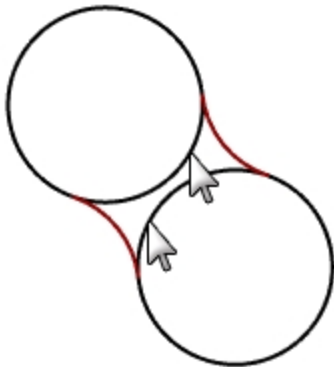

- On the **Edit** menu, click **Trim**.
- For the **Objects to trim**, select the inner edge of each circle.



---

**Fillet and join arcs and lines**

---

1. On the **Curve** menu, click **Fillet Curves**.  
Set **Join=Yes** and **Trim=Yes**.
2. Select the line in the lower left part of the viewport.  
Make sure you select the left half of the line.



3. Select the adjacent arc right above the selected line.
4. Repeat this procedure for the two arcs below the line and the arc you just filleted.

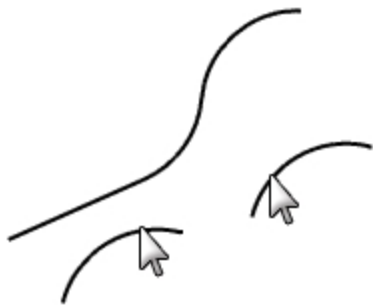

---

**Fillet the corners of a closed polyline**

---

1. Select the closed polyline.

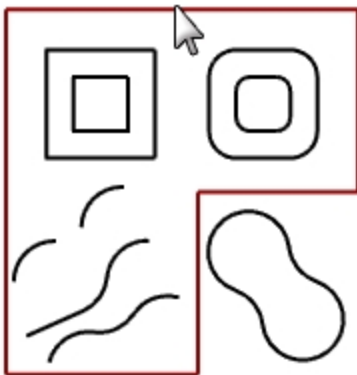

2. On the **Curve** menu, click **Fillet Corners**.

3. For the **Fillet radius**, type **2**, and press **Enter**.  
All corners are filleted at once.

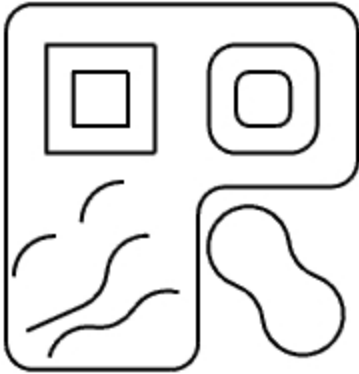

## Curve blends

Blending is another method to connect lines, arcs, or curves. There are two blend commands that work on curves: **BlendCrv** and **ArcBlend**.

### BlendCrv

The **BlendCrv** command allows you to adjust the continuity with the input curves and has adjustable endpoints. It also has options to **Join** and **Trim** the result.

#### Blend two curves with adjustable curve blend

---

1. On the **Curve** menu, **Blend Curves**, then click **Adjustable Curve Blend**.
2. Select the upper right curve near the left end, and then select the lower left curve near the right end to blend the curves.

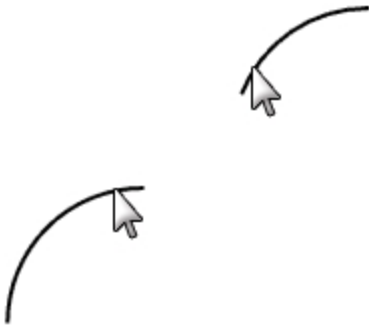

You will see a preview of the default blend with control points displayed and a dialog.

- In the **Adjust Curve Blend** dialog, check the **Join** and **Trim** options.

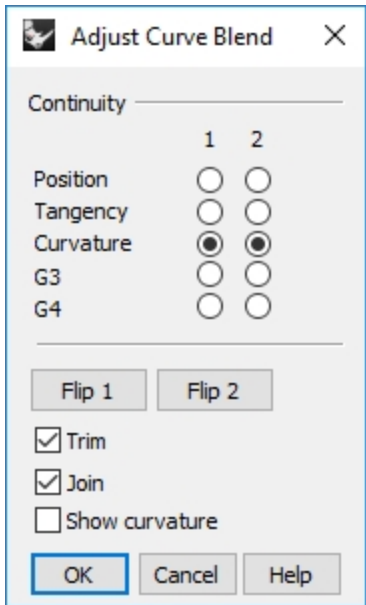

- For the **Select control point to adjust**, select point (1) and drag it further up the curve and click.

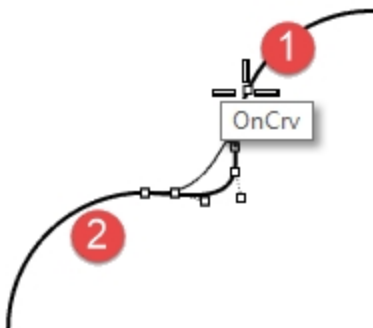

- For the **Select control point to adjust**, select the point to the right of (2), drag it closer to (2), and click.
- After making your adjustments, pick the **OK** button to make the blend.



- On the **Edit** menu, click **Undo**.
- Repeat **Adjust Curve Blend** with **Continuity** set to G3 and G4. Compare the results. Keep the blend curve you like the best.

## ArcBlend

**ArcBlend** consists of two arcs with adjustable endpoints and bulge.

### Blend two curves with ArcBlend

---

1. On the **Curve** menu, **Blend Curves**, then click **Arc Blend**.
2. Select the curves to blend near the ends that you want to connect.  
The two input curves are connected with two arcs.

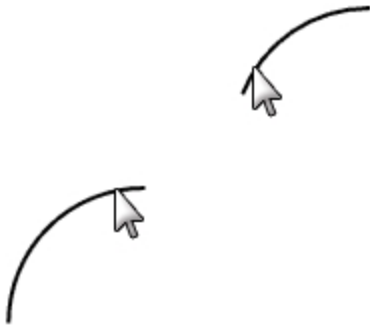

3. Preview the blend.



4. In the command-line, click the **Trim=yes** and **Join=yes** options.
5. **Enter** to create the blend.



## Loft

The **Loft** command fits a surface through selected profile curves that define the surface shape. Select the curves in the order in which the surface should pass through them. Select open curves near the same ends. For closed curves, use the preview to adjust the curve seams.

## Exercise 7-2 Lofting curves

### Make a lofted surface with closed curves

The curves in this model are at two different elevations. You are going to connect the curves at different elevations with a surface.

1. Change to the **Surfaces** layer.
2. In the **Top** viewport select the two squares in the upper left.
3. Make the **Perspective** viewport current.
4. On the **Surface** menu, click **Loft**.

The two squares show a seam direction arrow. They should point the same direction.

If the seams don't line up at corresponding points on the two curves, drag the seam point until it does.

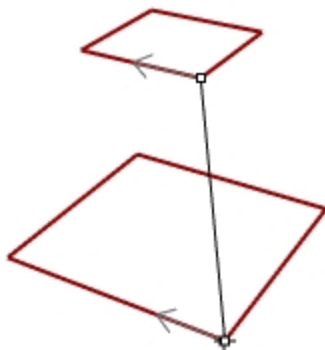

5. Press **Enter**.
  6. In the **Loft Options** dialog box, click **OK**.
- A surface is generated between the two closed polylines.

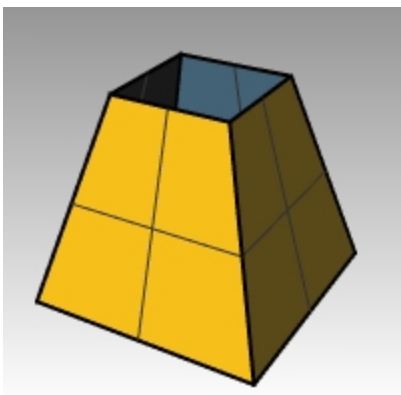

7. Repeat the procedure for the rounded squares.



8. In the **Loft Options** dialog box, click **OK**.

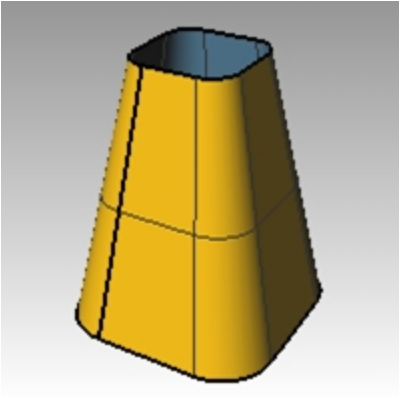

### Make a lofted surface with open curves

---

1. Repeat the **Loft** command for the three open curves.
2. In the **Loft Options** dialog box, change the **Style** to **Loose**, and click **Preview**.

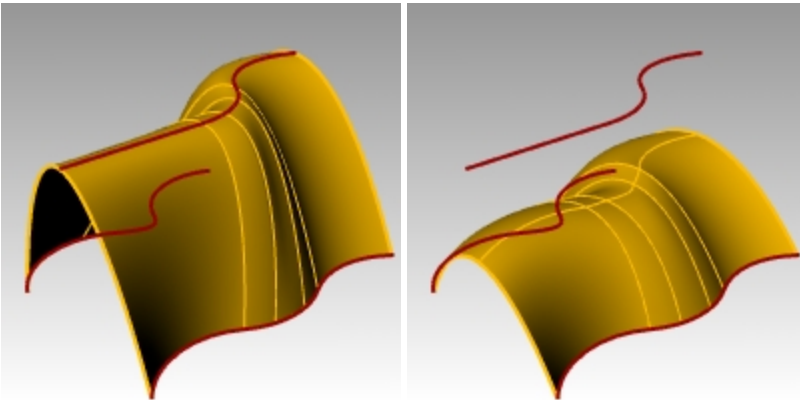

3. Change the **Style** to **Straight sections**, and click **Preview**.

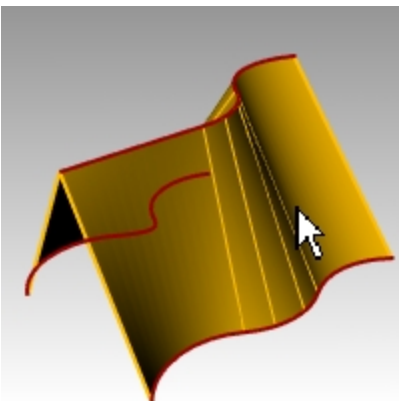



4. Change the **Style** to **Normal**, and click .
5. For the **Cross-section curve options**, click **Rebuild with**, set the number of control points to **12**, and click .

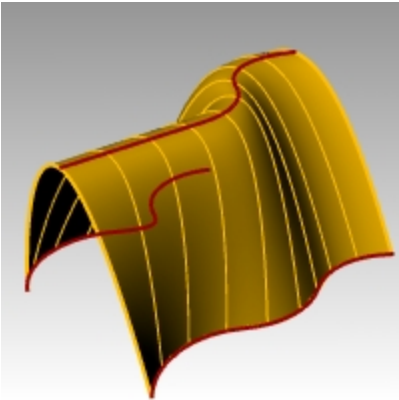

6. Click **Refit within**, click .
7. Click to **Do not simplify**, and click .

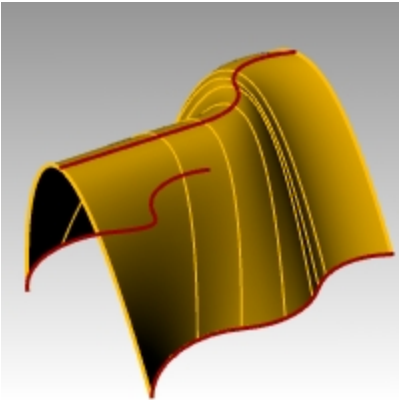

## Chamfer

Chamfer connects two curves by extending or trimming them to intersect or to join with a beveled line. Chamfer works on convergent or intersecting curves.

### Exercise 7-3 Chamfer lines

1. **Open** the model **Chamfer.3dm**.
2. On the **Curve** menu, click **Chamfer Curves**.
3. For the **Select first curve to chamfer**, to set the distances, type **1,1** and press .
4. Set **Join=Yes**.
5. Select one of the inner vertical lines.
6. Select an adjacent horizontal line.

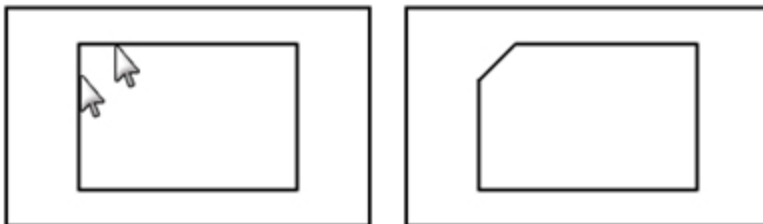

7. Continue creating chamfers on all of the corners.
8. Press  to repeat the command.
9. For the **Select first curve to chamfer**, type **3,2**, and press .

10. Select one of the outer horizontal lines.
11. Select an adjacent vertical line.

The first value is the distance from the intersection of the two curves on first curve selected, the second value is the distance from the intersection of the two curves on the second line selected.

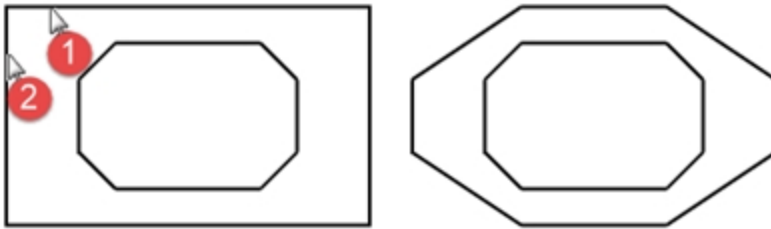

### Turn the curves into surfaces

1. Make the **Surfaces** layer current.
2. On the **Edit** menu, click **Select Objects**, and then click **Curves**.
3. On the **Surface** menu, click **Loft**.

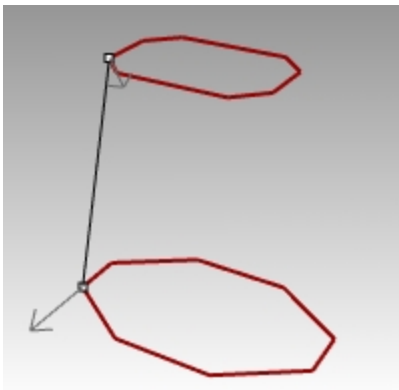

4. Adjust the seam line if necessary, press **Enter**.
5. In the **Loft Options** dialog box, click **OK**.  
A surface is generated between the two chamfered rectangles.
6. **Save** your model.

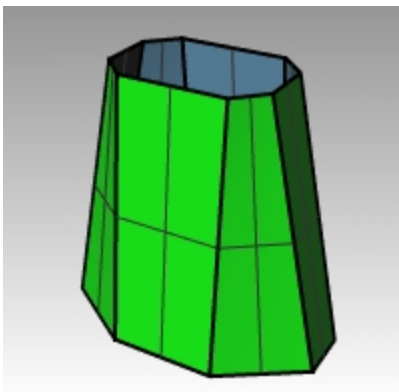

## Exercise 7-4 Practice with Fillet and Chamfer

1. Open the model **Filletex.3dm**.

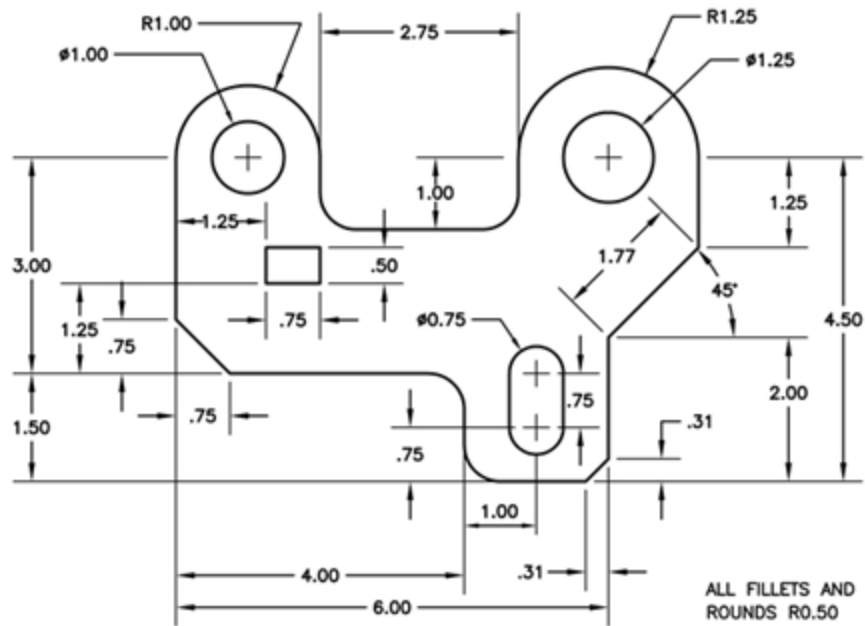

2. Use **Fillet** and **Chamfer** to edit the drawing as shown.  
All fillets and rounds use a radius of 0.5 units.

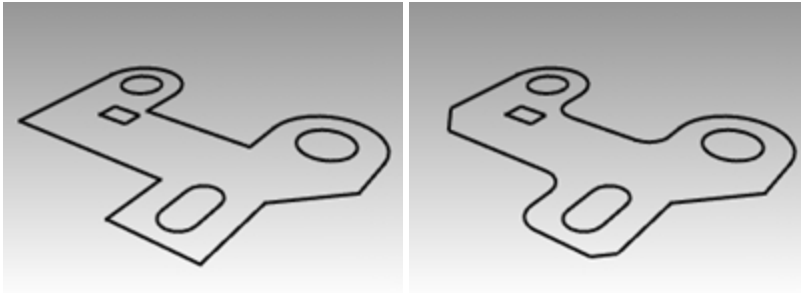

### Make it solid

1. On the **Edit** menu, click **Select Objects**, and then click **Curves**.
2. On the **Solid** menu, click **Extrude Planar Curve** and then click **Straight**.
3. For the **Extrusion distance**, type **1** and press **Enter**.

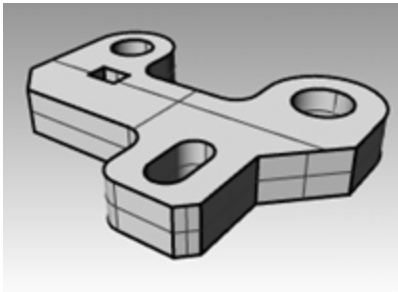

### Fillet the top edge of the solid

---

1. On the **Solid** menu, click **Fillet Edge**, and then click **Fillet Edge**.
2. Change the **Current radius** to **0.25**.
3. Select the edges around the top of the solid, and press **Enter**.

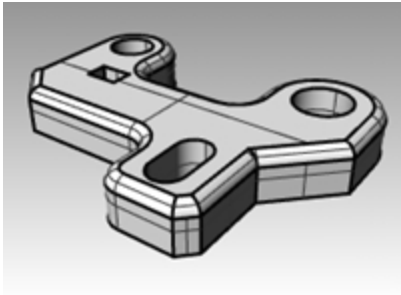

## Transform Commands: Move

Use the **Move** command to move objects without changing orientation or size

### Exercise 7-5 Transform Commands

---

1. **Open** the model **Move.3dm**.
2. Turn off both **Ortho** and **Grid Snap** so you can move objects freely.
3. Turn  **Cen** object snap on.



### Move using object snaps for placement

---

1. In the **Top** viewport, select the small circle at the bottom left side.
2. On the **Transform** menu, click **Move**.
3. For the **Point to move from**, snap to the center of the small circle.

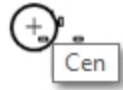
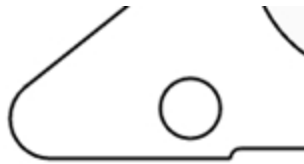

4. For the **Point to move to**, snap to the center of the arc at the lower left of the object.

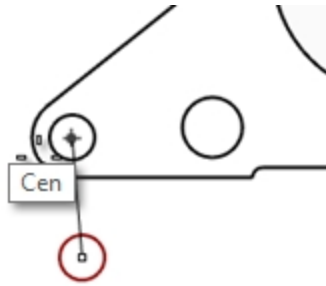

### Move using absolute coordinates

1. On the **Edit** menu, click **Select Objects**, and then click **Curves**.
2. On the **Transform** menu, click **Move**.
3. For the **Point to move from**, snap to the end of the line at the lower part of the object.
4. For the **Point to move to**, type **0,0**, and press **Enter**.  
The end of the line is exactly at point 0,0 in the **Top** viewport.

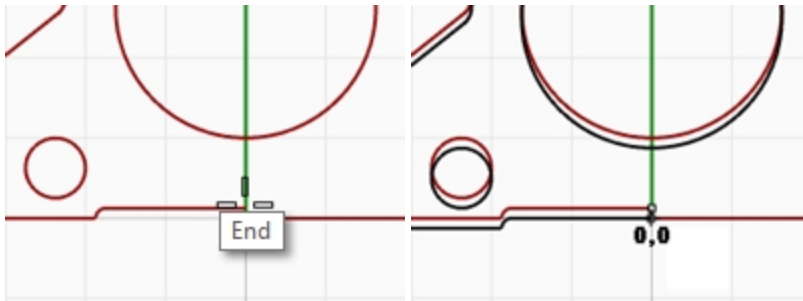

### Move using relative coordinates

1. Select the large slotted circle in the middle of the object.  
You will move the slotted circle relative to the part.
2. On the **Transform** menu, click **Move**.
3. In the **Top** viewport, pick any point.  
It is usually better if you pick near the object you are going to move.
4. For the **Point to move to**, type **r0,-.25** and press **Enter**.  
The circle moved down .25 units.

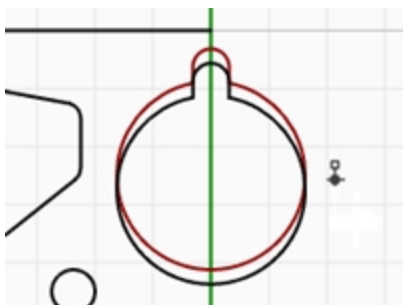

## Copy

The **Copy** command duplicates selected objects and places them in a new location. The command can repeat to create more than one copy in the same command sequence.

### Copy using object snaps for placement

1. Select the small circle at the lower left of the object.
2. On the **Transform** menu, click **Copy**.
3. For the **Point to copy from**, snap to the center of the small circle.

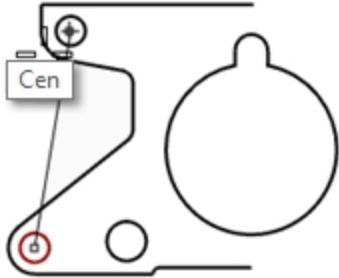

4. For the **Point to copy to**, snap to the center of the arc at the upper left of the object.
5. Pick to place the object, and press **Enter**.

### Make multiple copies

1. Select the small circle at the lower left of the object.
2. On the **Transform** menu, click **Copy**.
3. For the **Point to copy from**, snap to the center of the small circle.
4. For the **Point to copy to**, begin picking points on the screen. Each time you pick, a circle will be copied to that location.



5. Press **Enter** to end the command.
6. **Undo** the multiple copies.

## Undo and Redo

If you make a mistake or do not like the results of a command, use **Undo**. If you decide you want those undone results back after all, use **Redo** command. Redo restores the last thing undone.

If a command has an **Undo** option, type **U** to enter it, or click **Undo** on the command prompt.

You cannot use the **Undo** command after you exit the modeling session or open a different model.

## Rotate

Use Rotate to move objects in a circular motion around a base point. For precise rotation, enter a number of degrees to rotate. Positive numbers rotate counterclockwise; negative numbers rotate clockwise.

## Rotate objects

1. Select the large slotted circle in the middle of the object.
2. On the **Transform** menu, click **Rotate**.
3. For the **Center of rotation**, snap to the center of the slotted circle.

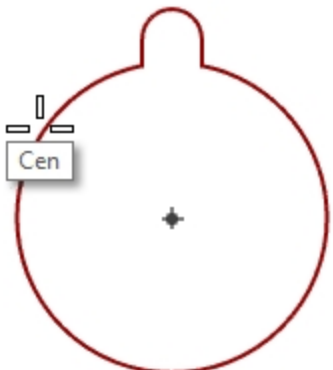

4. For the **Angle**, type **-28** and press **Enter**.



## Group

Grouping objects allows all members of the group to be selected as one. You can then apply commands to the entire group.

### Group selected objects

1. Select the two circles that you placed.
2. On the **Edit** menu, click **Groups**, and then click **Group**.

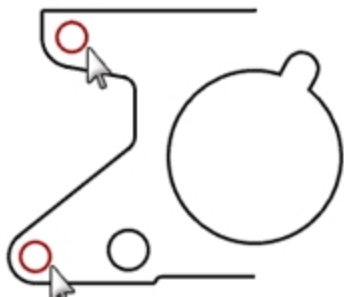

## Add objects to a group

1. Select the polyline on the left, the original circle, and the slotted circle in the center.
2. On the **Edit** menu, click **Groups**, and then click **Add To Group**.
3. For the **Select Group**, select one of the circles in the previous group.  
The objects are part of the group.

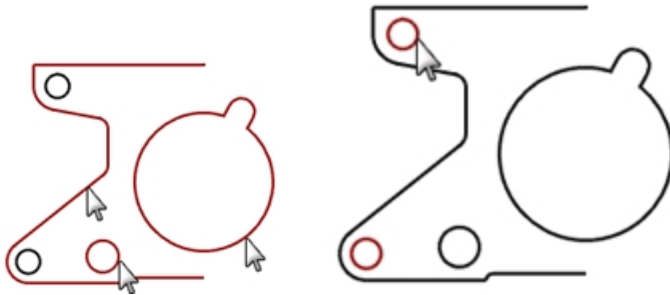

## Remove an object from a group

1. On the **Edit** menu, click **Groups**, and then click **Remove From Group**.
2. For the **Select objects to remove from group**, select the slotted circle, press **Enter**.  
The slotted circle is removed from the group.

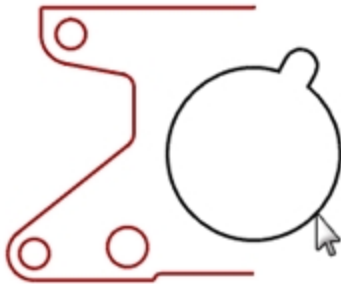

## Mirror

Mirror creates a copy of the objects flipped over a specified axis on the construction plane.

### Mirror objects

1. Select the group.
2. On the **Transform** menu, click **Mirror**.
3. For the **Start of mirror plane** type **0,0**, or snap to the end of the line at the lower right of the part.
4. Toggle **Ortho** on, and pick directly above the previous point.  
Since you mirrored a group, in addition to having a mirror image copy, you also have two groups.



## Join

Join unites curves that meet at a common end, making a single curve. Join can unite curves that do not touch, if you select them after the command has started. As you select non-touching curves, a dialog box asks if you want to fill the gap.



## Join objects

1. Select the two polylines.
2. On the **Edit** menu, click **Join**.

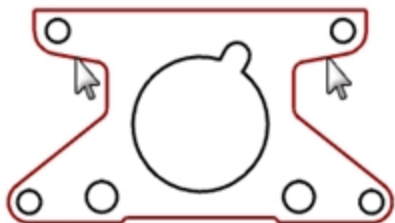

## Scale

Scale changes the size of existing objects without changing their shape. This command scales three-dimensional objects equally along all three axes. There are also two-dimensional, one-dimensional, and non-uniform scale commands.

### Scale objects

1. On the **Edit** menu, click **Select Objects**, and then click **Curves**.
2. On the **Transform** menu, click **Scale**, and then click **Scale 2-D**.
3. For the **Origin point**, type **0**, and press **Enter**.
4. For the **Scale factor**, type **.75**, and press **Enter**.

The whole part scaled to 75 percent of its original size.

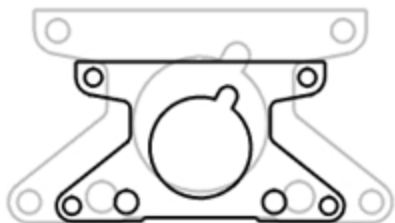

### Scale2D using the reference point option

1. Select the slotted circle.
2. On the **Transform** menu, click **Scale**, and then click **Scale 2-D**.
3. For the **Origin point**, snap to the center of the slotted circle.

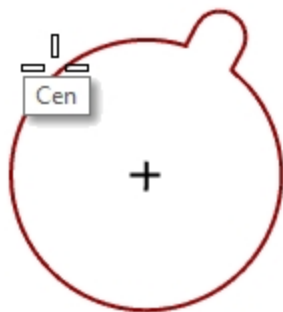

4. For the **First reference point**, snap to the quadrant of the slotted circle. The radius of the slotted circle is the reference for the scale factor.

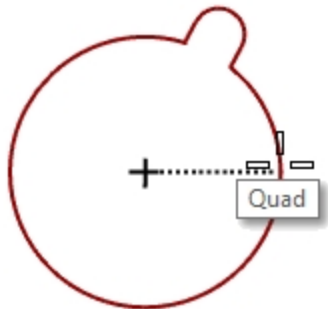

5. For the **Second reference point**, type **1.375** and press **Enter**. The slotted circle now has a larger radius of 1.375.



### Make it solid

---

1. On the **Edit** menu, click **Select Objects**, and then click **Curves**.
2. On the **Solid** menu, click **Extrude Planar Curve**, and then click **Straight**.
3. For the **Extrusion distance**, type **1**, and press **Enter**.

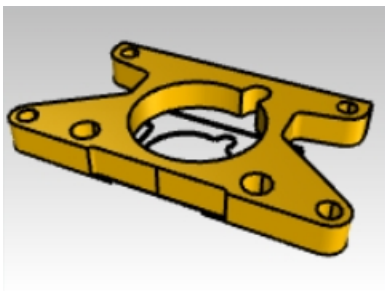

### Scale in 3-D

---

1. On the **Edit** menu, click **Select Objects**, and then click **Polysurfaces**.
2. On the **Transform** menu, click **Scale**, and then click **Scale 3-D**.
3. For the **Origin point** type **0**, and press **Enter**.

- For the **Scale factor** type **1.5**, and press **Enter**.  
The solid is larger in every dimension.

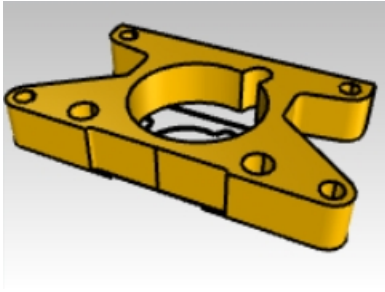

### Scale in one dimension

- On the **Edit** menu, click **Select Objects**, and then click **Polysurfaces**.
- On the **Transform** menu, click **Scale**, and then click **Scale 1-D**.
- For the **Base point**, type **0**, and press **Enter**.
- For the **First reference point**, snap to the **End** point at the top of the part.

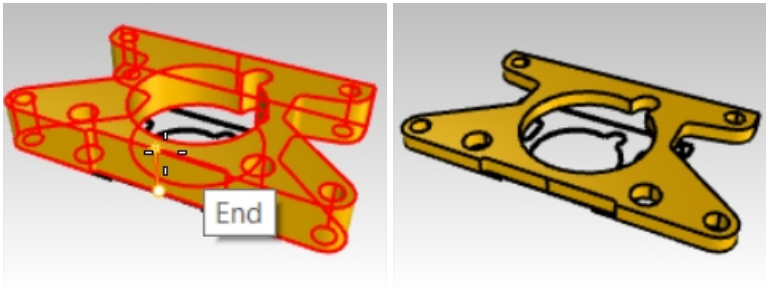

- For the **Second reference point**, type **.5**, and press **Enter**.  
The object is half as thick.

### More on gumball

Gumball displays a widget on a selected object, which is used to facilitate the direct editing. The gumball provides move, scale, and rotate transformations around the gumball origin.

- Click the **Gumball** pane on the **Status Bar**.

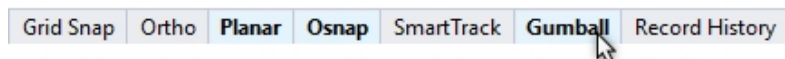

### Exercise 7-6 Gumball menu

In this exercise, we will drag gumball arrows to move an object. Three direction arrows: x (red), y (green), and z (blue) control the direction.

1. **Open** the model **Gumball.3dm**.

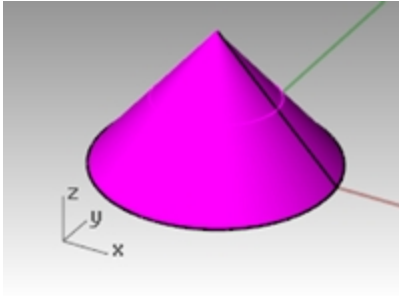

2. In the **Front** viewport, select the cone.

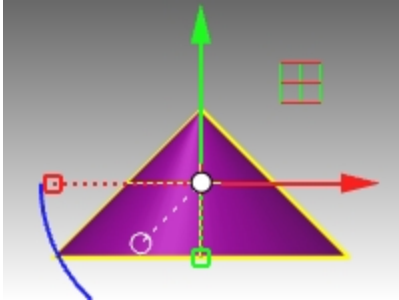

3. Right-click and hold on any part of the Gumball widget.

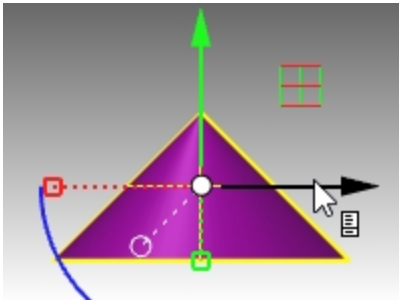

When the page icon appears, release the right mouse button. The Gumball pop-up menu will appear.

4. Click **Relocate Gumball**.

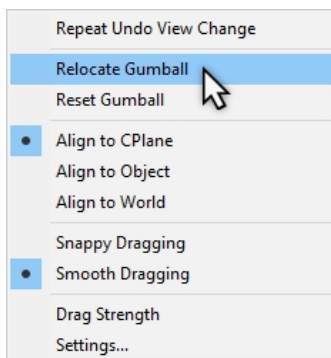

- With the **End point** object snap, pick the top of the cone, and press **Enter** to complete the relocation of the Gumball.

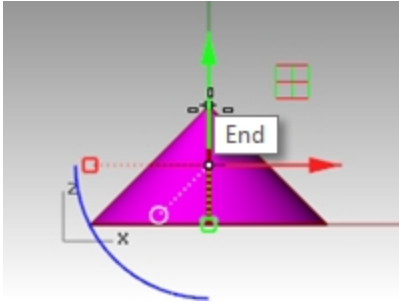

The gumball origin is now located at top of cone. All editing is in reference to the new origin.

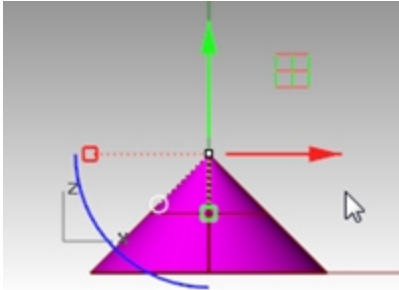

- Click the **Blue arc**.  
A text edit box will appear. You can type a rotation angle into this box to rotate an object an exact angle.
- Type **90** and press **Enter**.  
The cone is rotated exactly 90 degrees in a counter clockwise direction.

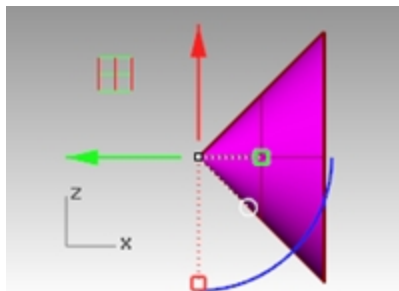
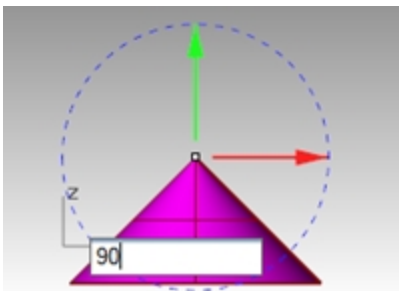

## Exercise 7-7 The 3D Puzzle

Use the **Gumball** to orient the puzzle pieces in 3D.

For additional practice, also use **Rotate3D** and **Orient3Pt** to orient some of the puzzle pieces. Use the Help for details about these commands. Discuss how these commands are different than using the Gumball.

- In the **Layer** panel, do the following:
  - Make **Default** the current layer.
  - Turn off the **Cone** layer.
  - Turn on the parent **Puzzle** layer.

**Note:** The **Puzzle** layer contains sub-layers. Turning on or off the parent **Puzzle** layer, affects the sub-layers visibility, too.

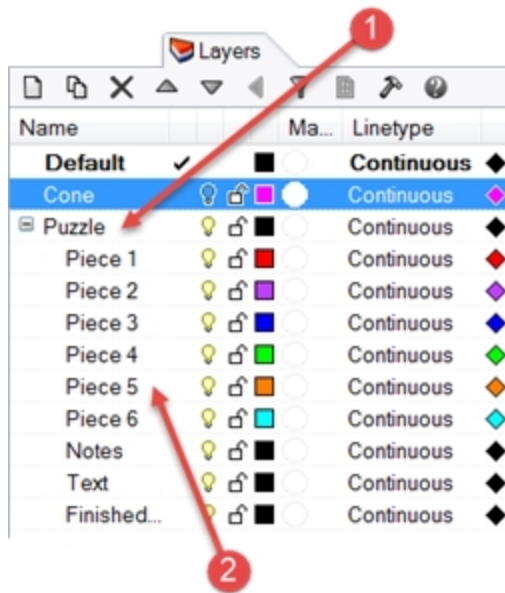

(1) Parent layer; (2) Sublayers.

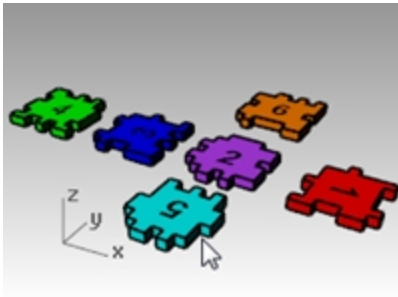

2. On the **View** menu, select **Zoom** and **Zoom Extents All** (Alt+Ctrl+E) to see the puzzle pieces.
3. On the **Status Bar**, turn **Ortho** and **Grid Snap** on. Next right-click **Grid Snap** and click **Settings**.
4. For the **Snap Spacing**, type a value of **0.05**.
5. Click **OK**.

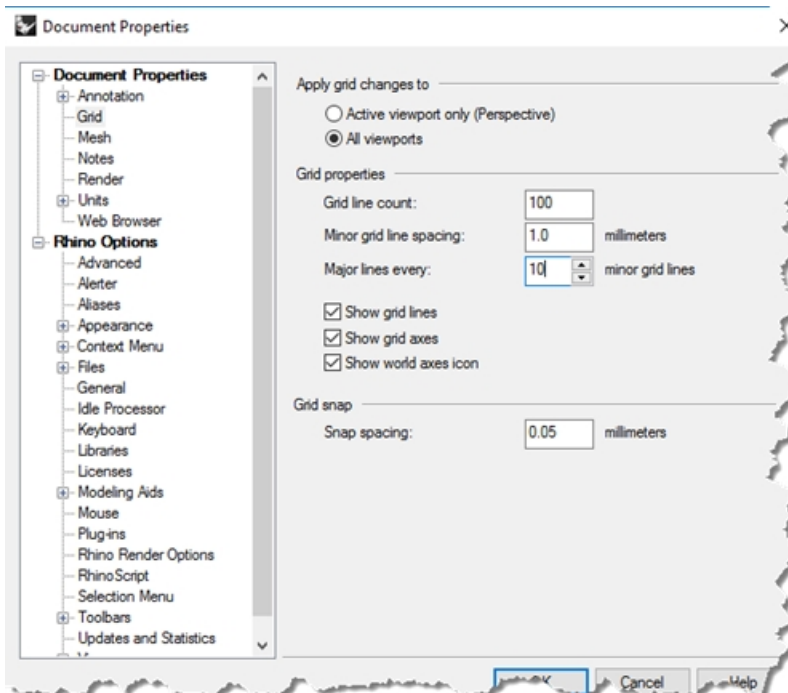

## Reposition the puzzle pieces

1. In the **Perspective** viewport, select the red puzzle **Piece 1**.

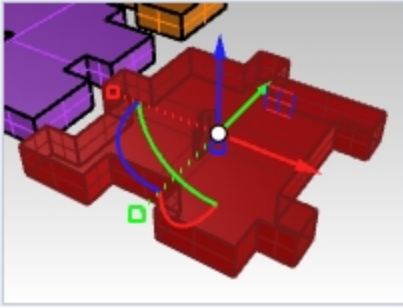

2. Right-click and hold on any part of the Gumball widget.

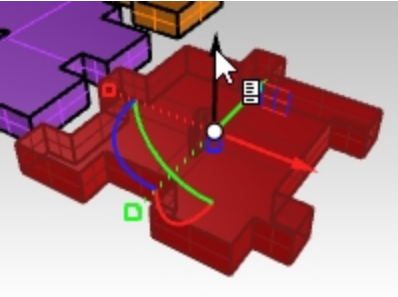

3. When the page icon appears, release the right mouse button. The Gumball pop-up menu will appear.
4. Click **Relocate Gumball**.

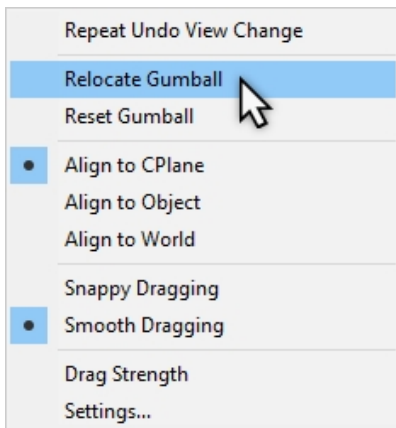

5. With the **End** point object snap, pick lower left corner of the piece and press **Enter** to complete the relocation of the Gumball.

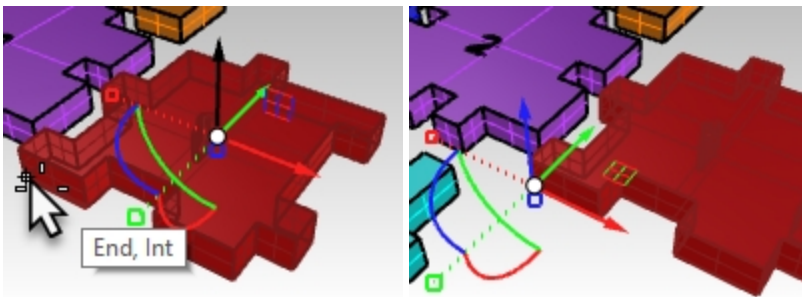

- In the **Front** viewport, click and drag along blue arc to rotate pieces to 90 degrees.  
**Note:** Hold the **Shift** key down to temporarily toggle the **Ortho** setting.

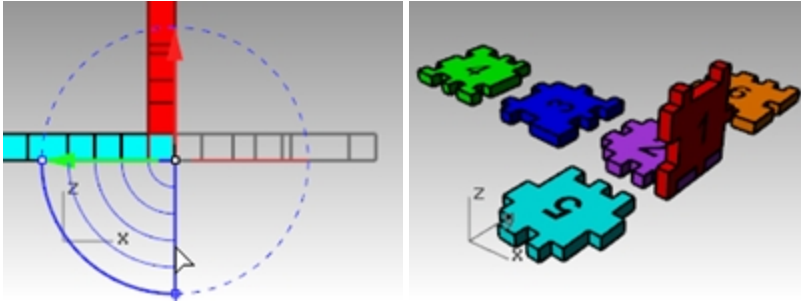

### Orient 3Point

The **Orient3Pt** command moves or copies and rotates objects using three reference and three target points.

- Undo the previous transformation with Gumball.
- Again, in the **Perspective** viewport, select the red puzzle **Piece 1**.

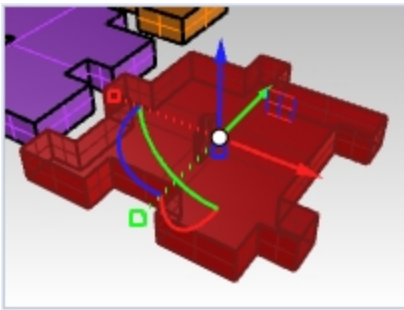

- On **Transform** menu, select **Orient**, then **3Points**.
- Pick **Reference** points 1, 2 and 3 as shown image below.

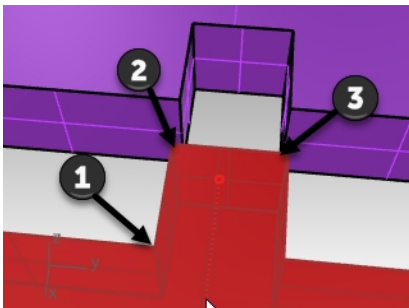

- Pick **Targets** points 1, 2 and 3 as shown image below.



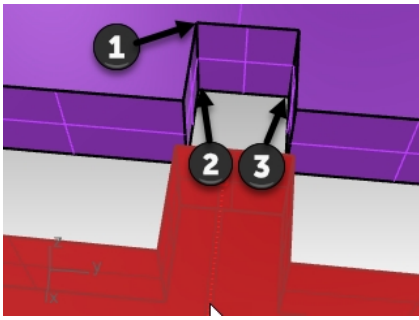

6. Now the Piece 1 is transformed to the new location and orientation.

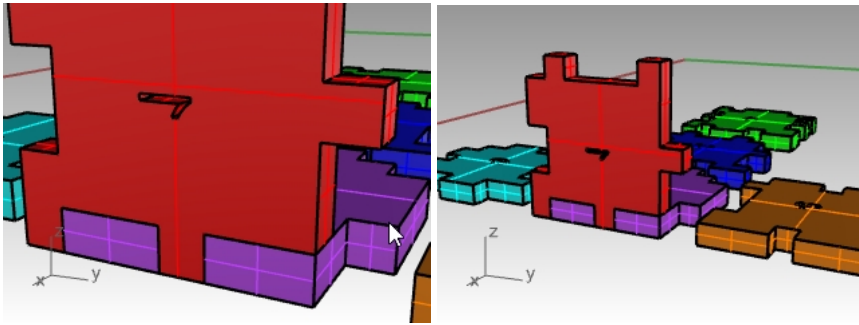

### Transforming the other puzzle pieces

You choose how to transform puzzle Pieces 3, 5, 6. You may use **Gumball** or **Orient3Pt**.

1. **Move** with **Gumball**.
2. **Relocate Gumball** origin.
3. **Rotate** with **Gumball**.

Use the appropriate viewport for rotation.

**Hint:** In the **Front** viewport, rotate Piece 3. In the **Right** viewport, rotate Piece 5 and Piece 6.

### Puzzle Piece 3

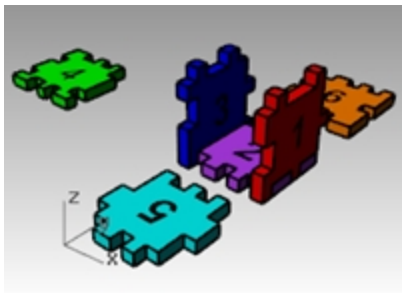
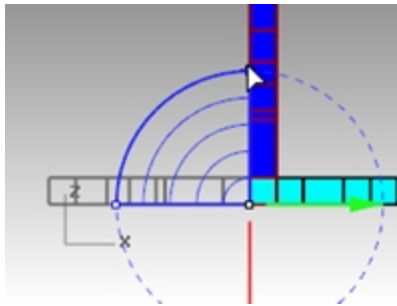
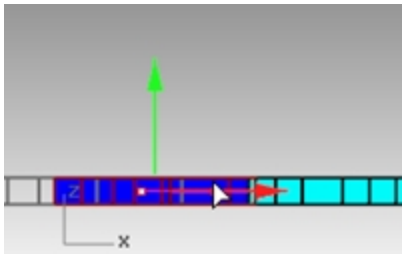

**Puzzle Piece 5**

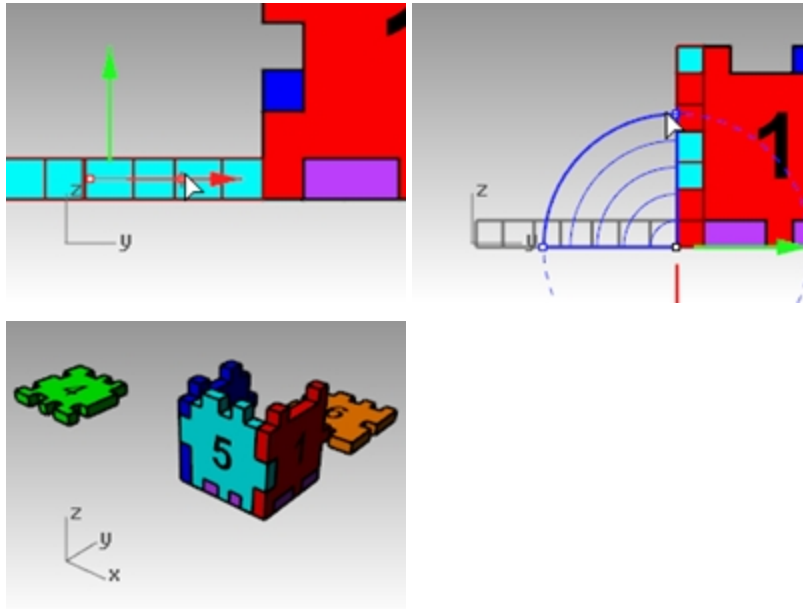

**Puzzle Piece 6**

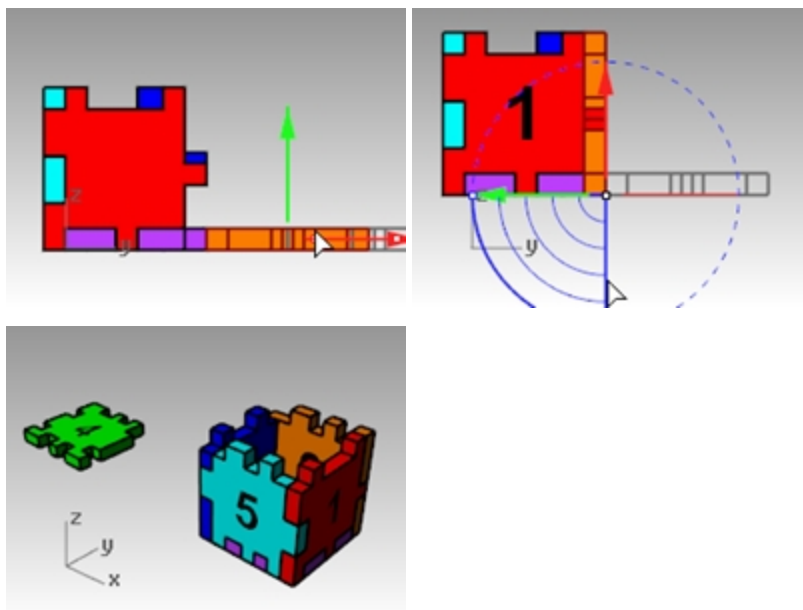

- Now use gumball to move the final **Piece 4** into position on the top of the box using the **Axis plane indicator**. Drag by the plane icon to constrain movement to that plane.

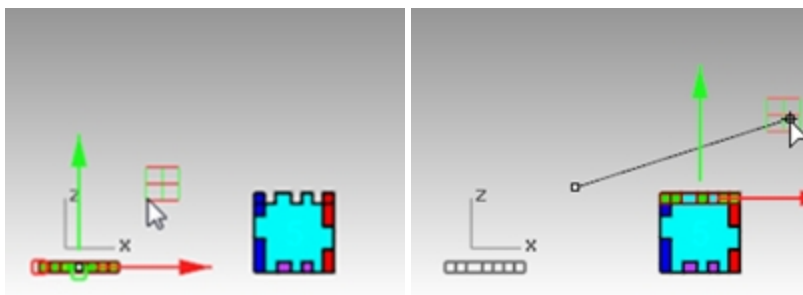

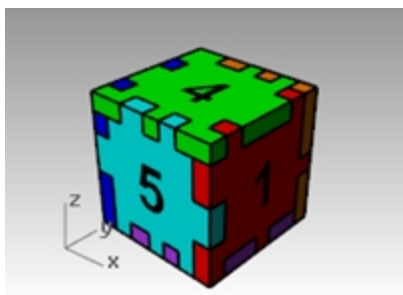

## Trim

Trim cuts and deletes portions of an object to make it end precisely at its intersection with another object. In this exercise, we will pre-select the cutting objects.

### Exercise 7-8 Trim curves

1. **Open** the model **Trim-Split.3dm**.
2. Toggle **Gumball** off.
3. In the **Top** viewport, **Zoom Window** around the grid in the lower left corner.
4. For the cutting objects, select the two outside vertical lines in the grid.

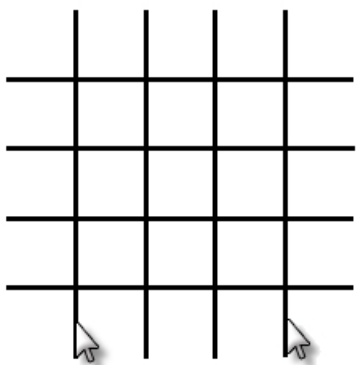

5. On the **Edit** menu, click **Trim**.
6. Select each of the horizontal lines at their left and right ends. The lines are trimmed to the cutting edges.
7. Press **Enter**.

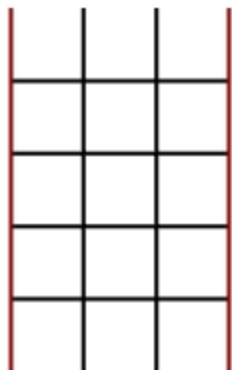

## Trim surfaces

---

1. In the **Perspective** viewport, **Zoom Window** around a sphere and surface.
2. In the **Perspective** viewport, select the surface that intersects the sphere as the cutting object.

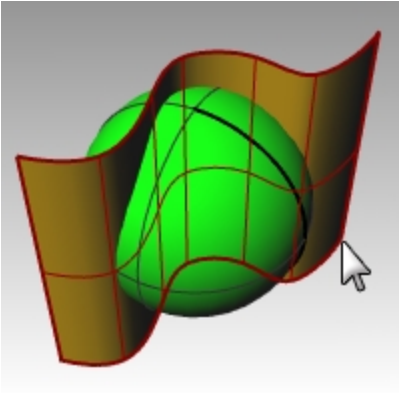

3. On the **Edit** menu, click **Trim**.
4. For the **Object to trim**, pick the right side of the sphere.

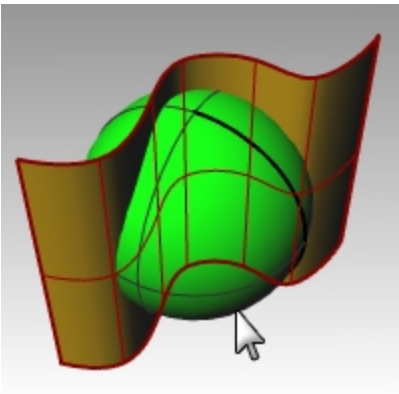

The sphere is trimmed at the surface.

5. Press **Enter**.

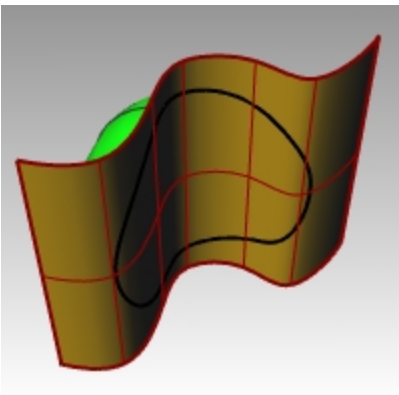

## Split

The **Split** command divides objects into parts using other objects as cutters. The **Split** command breaks the object where it intersects the cutting object but does not delete anything.

In this exercise, we will pre-select the object or objects we are going to split.

---

**Split a curve**

---

1. In the **Top** viewport, **Zoom Window** around the closed curve in the lower right corner.
2. Select the closed curve.

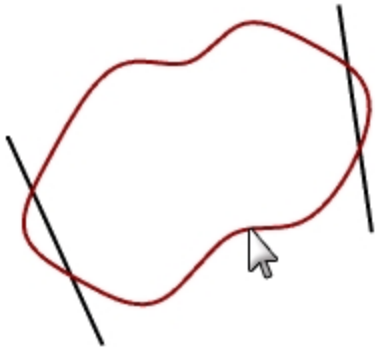

3. On the **Edit** menu, click **Split**.
4. Select the lines, and press **Enter**.

The curve is separated into four curves precisely where the lines intersect it.

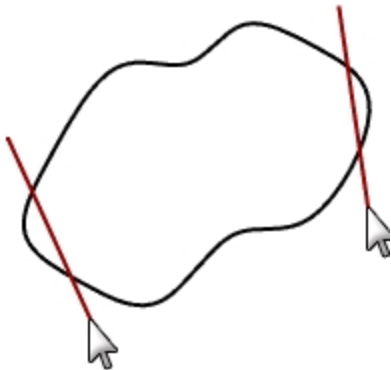

---

**Split a surface**

---

1. On the **View** menu, click **Zoom**, and then click **Zoom Extents All**.
2. Select the sphere (green).

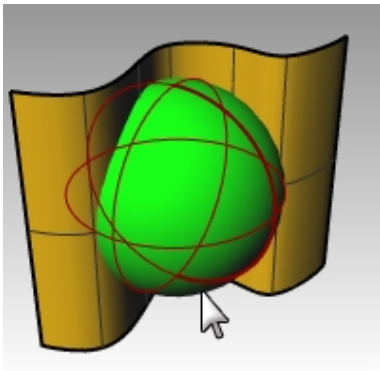

3. On the **Edit** menu, click **Split**.

4. Select the extrusion surface (gold), and press **Enter**.

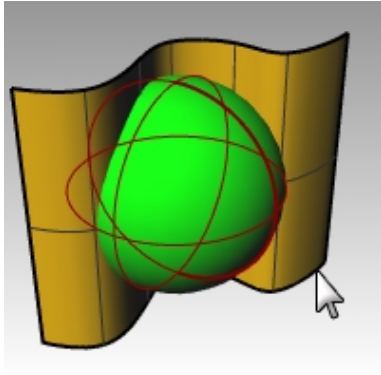

The sphere is separated into two pieces where the surface intersects it

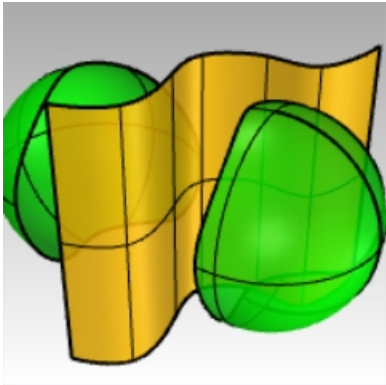

## Extend

The **Extend** command lengthens an object to make it end precisely at its intersection with another object or you can lengthen an object when there is no intersection.

### Exercise 7-9 Extend curves

---

1. **Open** the model **Extend .3dm**.
2. On the **Curve** menu, click **Extend Curve**, and then click **Extend Curve**.
3. For the **Select boundary objects**, select the line at the left and the curve at the right.



4. To close the selection of boundary curves, press **Enter**.
5. For the **Select curve to extend**, in the Command line, click set **Type=Line**.

6. Select both ends of the top line and the left end of two curves.  
The curve and line extend to touch the boundary. The extension is a straight segment.



7. For the **Select curve to extend**, in the Command line, set **Type=Arc**.
8. Select the right end of the middle curve.  
The curve extends with a tangent arc to touch the boundary.

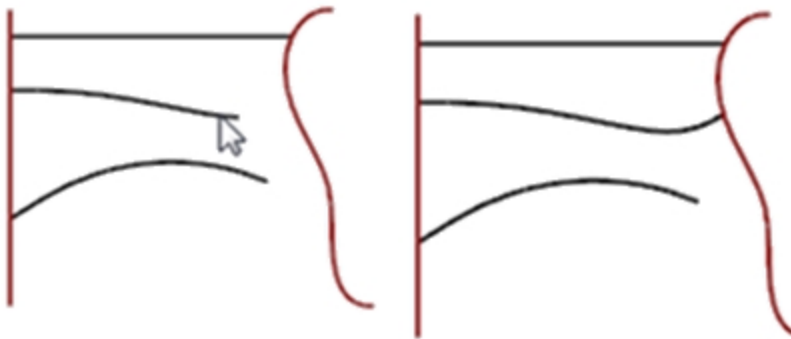

9. For the **Select curve to extend**, in the Command line, set **Type=Smooth**.
10. Select the right side of the bottom curve.  
The curve extends with a curvature (G2) continuous extension to touch the boundary.
11. Press **Enter** to end the command.

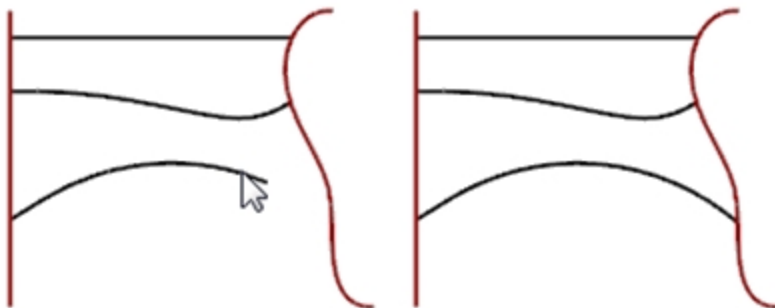

### Extend with a set extension length

1. On the **Curve** menu, click **Extend Curve**, and then click **Extend Curve**.
2. At the **Select boundary objects or enter extension length...** prompt, type **4**, and press **Enter**.
3. In the Command line, set **Type=Smooth**.

4. Select the upper end of the curve on the right.  
The curve extends exactly four units.

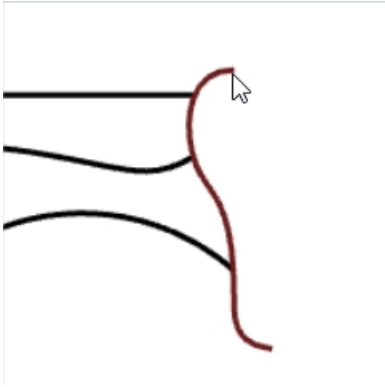

5. Press **Enter** to end the command.

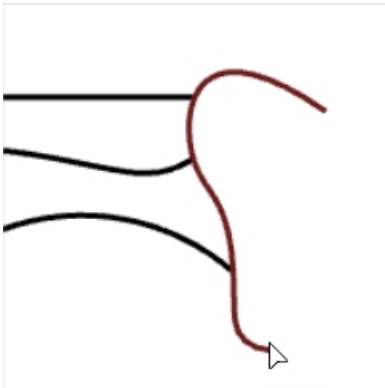

---

### Extend a curve dynamically

1. On the **Curve** menu, click **Extend Curve**, and then click **Extend Curve**.
2. At the **Select boundary objects...** prompt, press **Enter** for a dynamic extension.
3. In the Command line, set **Type=Smooth**.



4. Select the lower end of the curve on the right.

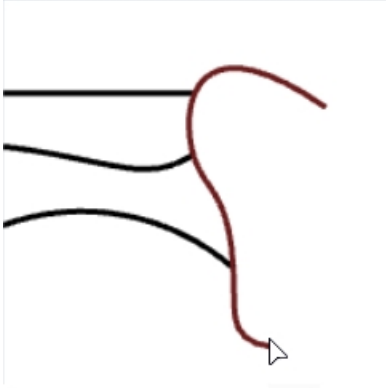

The curve continues with the cursor.

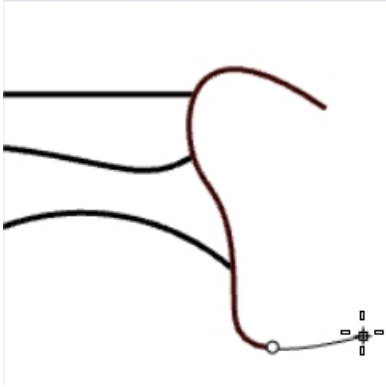

5. On the Command line, click **ToPoint**.
6. Click to end the extension at a point.

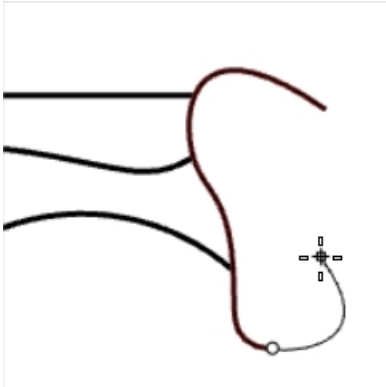

7. Press **Enter** to end the command.



## Extend to a surface

1. On the **Curve** menu, click **Extend Curve**, and then click **Extend Curve**.
2. For the **boundary objects**, select the cylinder on the left and the surface on the right.
3. Press **Enter**.

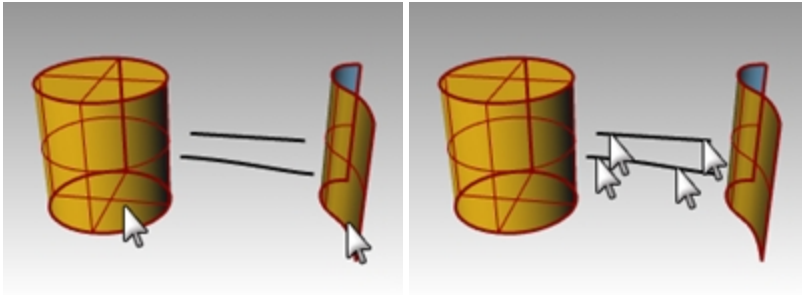

4. Change the type to **Type=Arc**.
5. Select both ends of the line and the curve.  
The curves extend to the surface of the cylinder and to the surface.

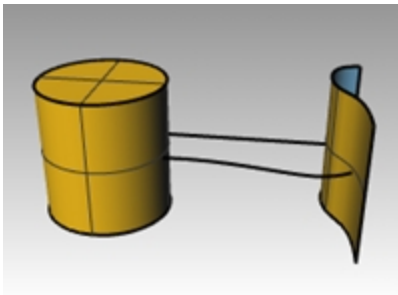

## Offset

The **Offset** command creates an object parallel or concentric to another object. Use Offset to create specialized copies, such as parallel lines, concentric circles, and concentric arcs, through specified points or at pre-set distances.

### Exercise 7-10 Offset curves

1. **Open** the model **Offset.3dm**.
2. **Maximize** the **Top** viewport.
3. Select the line.
4. On the **Curve** menu, click **Offset**, then click **Offset Curve**.

- For the **Side to offset**, pick the upper right side of the line.

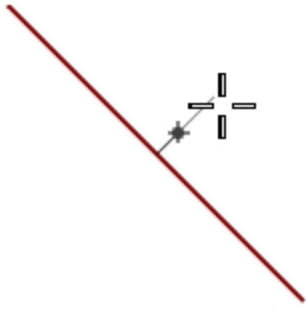

A parallel line is created.



#### Offset with the through point option

- Turn on the **End** object snap.
- Select the circle.
- On the **Curve** menu, click **Offset**, and then click **Offset Curve**.
- For the **Side to offset**, in the Command line, click **Throughpoint**.
- For the **Throughpoint**, snap to the lower right end of the line you offset.  
A concentric circle is created that goes through the endpoint of the line.

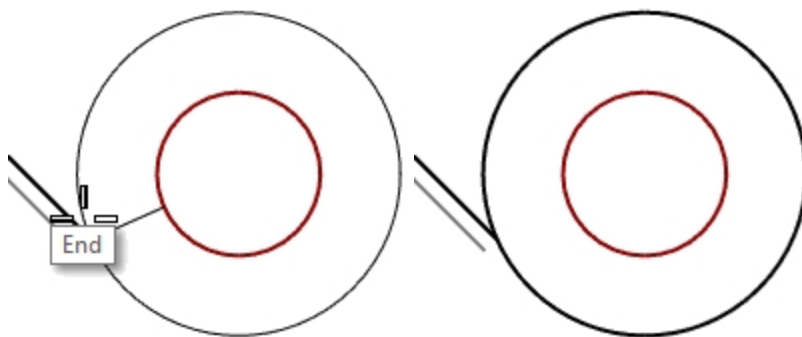

#### Offset a polyline with sharp corners

- Select the polyline.
- On the **Curve** menu, click **Offset**, then click **Offset Curve**.
- To change the offset distance, type **1**, and press **Enter**.

4. For the **Side to offset**, pick inside the polyline.  
The polyline is offset with sharp corners.

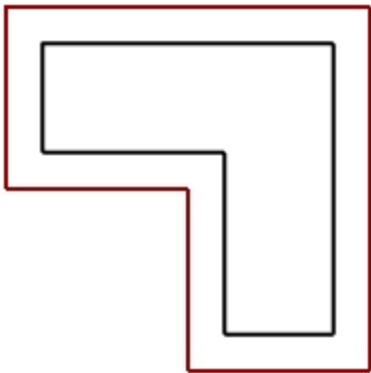

### Offset a polyline with round corners

---

1. Select the polyline.
2. On the **Curve** menu, click **Offset**, then click **Offset Curve**.
3. In the Command line, set **Corner=Round**.
4. Pick outside the polyline.

The polyline is offset, but the corners are rounded with arcs.

Other corner options include **Smooth** and **Chamfer**. Smooth makes a tangent curve that is smoother than an arc at each vertex, while Chamfer makes a bevel at each vertex.

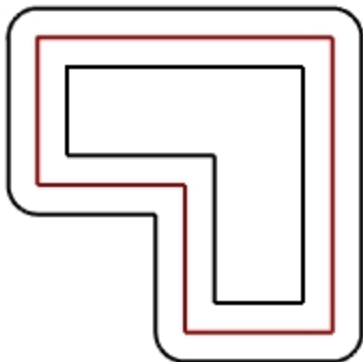

### Offset a curve on bothsides

---

1. Select the free-form curve.
2. On the **Curve** menu, click **Offset**, then click **Offset Curve**.
3. In the Command line, click **Bothsides**.
4. For **Side to offset**, pick either side of the curve.  
Free-form curves are created on both sides of the selected curve.



5. Repeat this process on the arc.  
Concentric arcs are created on both sides of the selected arc.
6. From the **Edit** menu, click **Undo**.

---

**Offset a curve on bothsides with caps**

---

1. Select the arc.
2. On the **Curve** menu, click **Offset**, then click **Offset Curve**.
3. In the Command line, click **Cap**, and then click **Round**.
4. Click **Bothsides** in the Command line.
5. For **Side to offset**, pick either side of the curve.  
Concentric arcs are created on both sides of the selected arc with a rounded end piece connecting the offset curves.

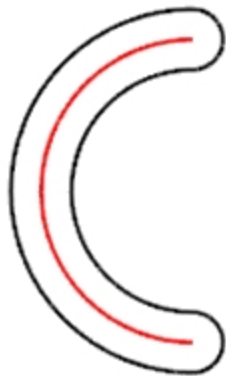

## Offset a surface

1. Select one of the open surfaces.
2. On the **Surface** menu, click **Offset Surface**.
3. Place your cursor over the surface and click to change the offset direction.

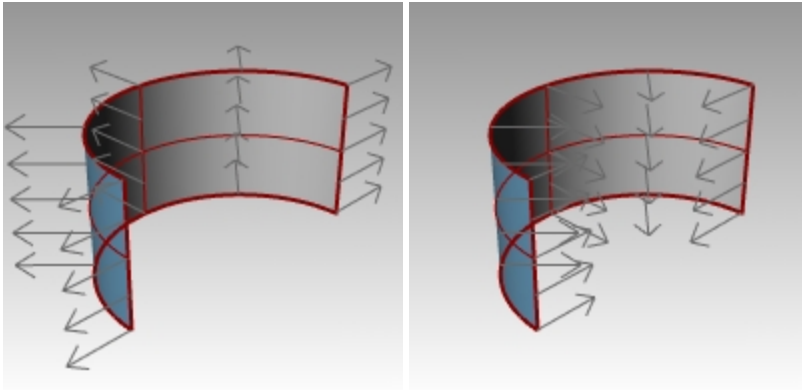

4. Press **Enter**.  
The surface is offset in the direction of the arrows.

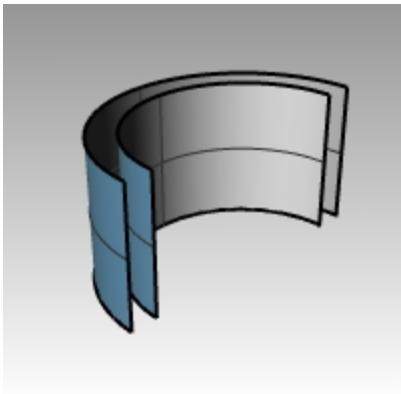

## Offset a surface to a solid

1. Select the other open surface.
2. On the **Surface** menu, click **Offset Surface**.
3. If necessary, click the surface to change the normal direction.
4. In the **Command line**, click the **Solid** option.
5. Press **Enter** to create the offset surface and the surfaces needed to make the solid.

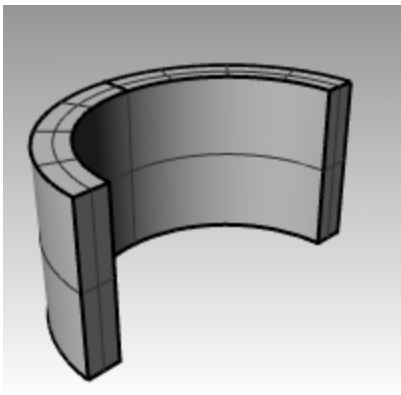

## Offset a polysurface

Offsetting polysurfaces may not give the desired results. In this example we will demonstrate some of the problems.

1. Select the cylinder.
2. On the **Surface** menu, click **Offset Surface**.

The normals on a closed polysurface will always point to the outside.

3. In the Command line, click **Distance**, and type **1**.

4. Set **Corners=Round**, and press **Enter**.

Each surface of the polysurface is offset as a separate surface, then extended or filleted, and joined together as a solid.

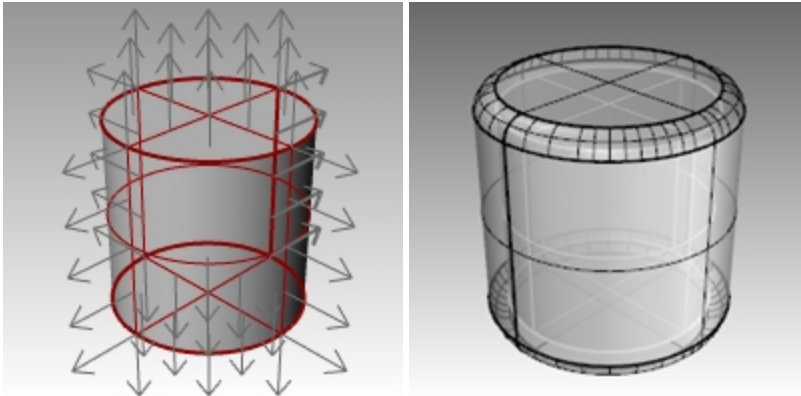

5. **Undo**. Repeat the command and set **Corners=Sharp**.

What you have in both cases is a solid inside of a solid.

**Hint:** Select the object, and on the **Properties** panel, click the **Details** button, to confirm that offset polysurface is a closed solid.

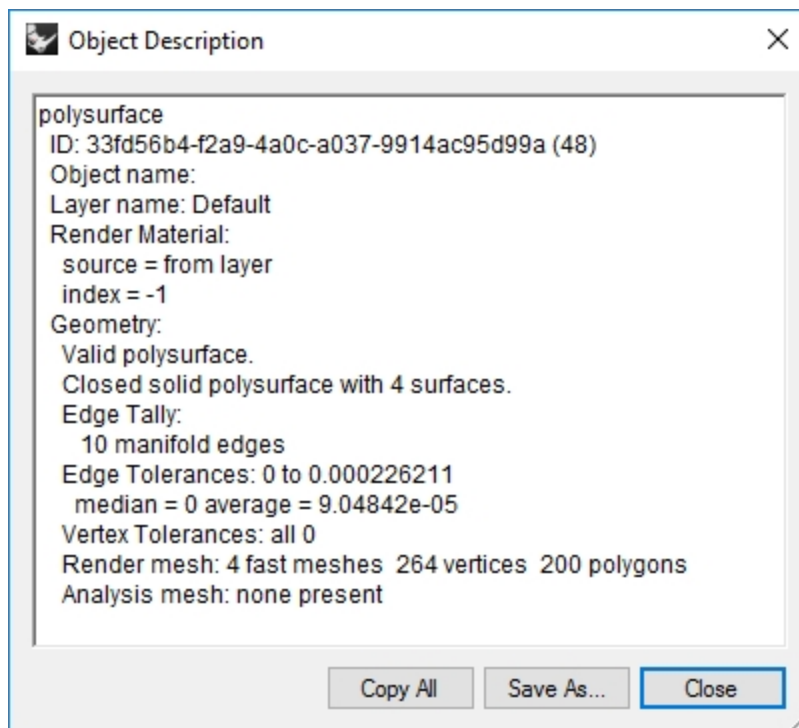
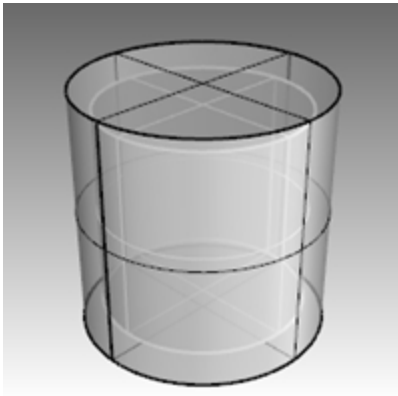

### Shell a polysurface

---

1. **Undo**.
2. Select the **Cylinder**.
3. In the Command line, type **Shell**.
4. For **Select faces to remove** pick the top of the cylinder and press **Enter**.  
The surface is removed and the remainder is offset inward, using the outer parts of the removed surface to join the inner and outer parts.

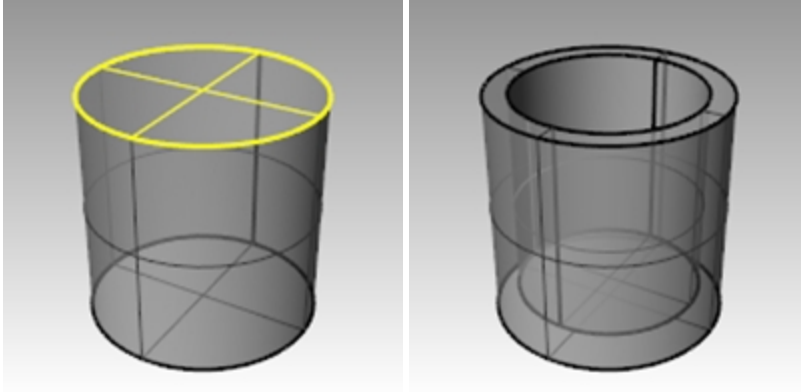

## Array

Use the **Array** commands to make multiple copies of selected objects.

**Array Rectangular** copies objects in rows (x direction), columns (y direction) and levels (z direction).

**Array Polar** copies objects in a circle around a center point.

### Exercise 7-11 Array

---

#### Create a polar array

---

1. **Open** the model **Array.3dm**.
2. In the **Top** viewport, select the small circle.
3. On the **Transform** menu, click **Array**, and then click **Polar**.
4. For the **Center of polar array**, snap to the center of the large circle.

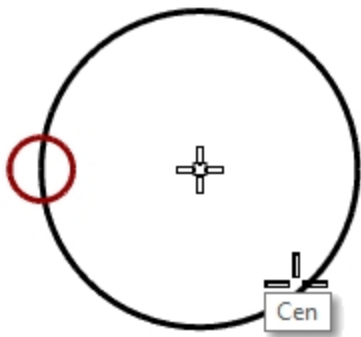

5. For the **Number of items**, type **10** and press **Enter**.



- For the **Angle to fill**, check to see if it is set to **360**, press .  
The small circle is arrayed around the larger one.

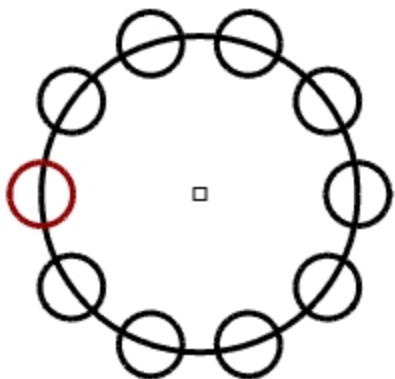

- Save** your model.  
**Note:** You must include the original and the copies as the number in the array.

#### Make the shape for the column

- Window select** the circles.
- On the **Curve** menu, click **Curve Edit Tools**, then click **Curve Boolean**.
- For the **Regions to keep**, click inside the large curve.  
The inside of the circle, excluding the smaller circles is shaded.

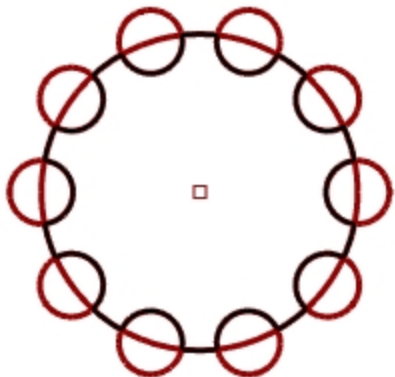

- In the Command line, click **DeleteInput**, click **All**, and press .

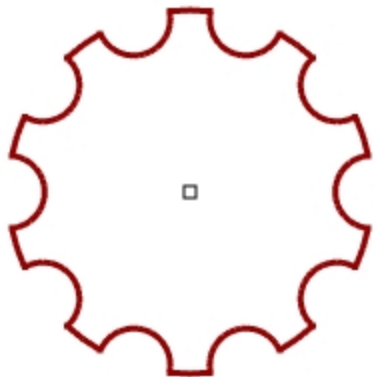

### Make the column

---

1. Select the new polycurve.
2. On the **Solid** menu, click **Extrude Planar Curve**, then click **Straight**.
3. For the **Extrusion distance**, type **14**, press **Enter**.

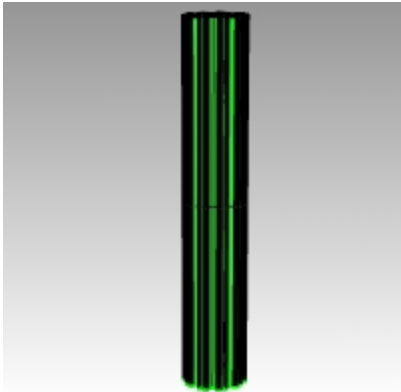

### Make a partial polar array

---

1. Turn on the **Base** layer.
2. Select the column base, the column, and the column cap.
3. On the **Edit** menu, click **Groups**, then click **Group**.  
The three parts are grouped into one.
4. Select the group.
5. On the **Transform** menu, click **Array**, and then click **Polar**.
6. For the **Center of polar array**, type **0**, press **Enter**.
7. For the **Number of items**, type **6** and press **Enter**.

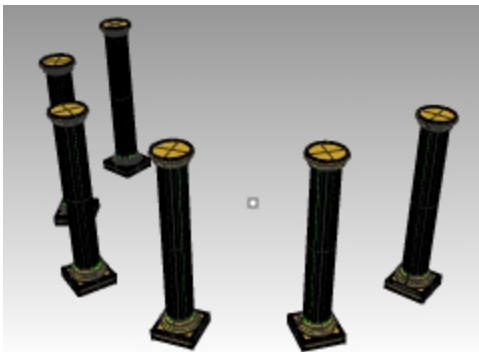

8. For the **Angle to fill**, type **-180**, press **Enter**.  
Six columns are arrayed to fill 180 degrees in the negative direction.

### Rectangular array

Array Rectangular makes rows and columns of objects.

#### Create a rectangular array

---

1. Select the same column group as the last exercise.
2. On the **Transform** menu, click **Array**, then click **Rectangular**.
3. For the **Number in X direction**, type **4**, press **Enter**.
4. For the **Number in Y direction**, type **4**, press **Enter**.
5. For the **Number in Z direction**, type **1**, press **Enter**.
6. For the **X spacing**, type **12** and press **Enter**.

- For the **Y spacing**, type **12** and press **Enter**.  
The columns are visible.

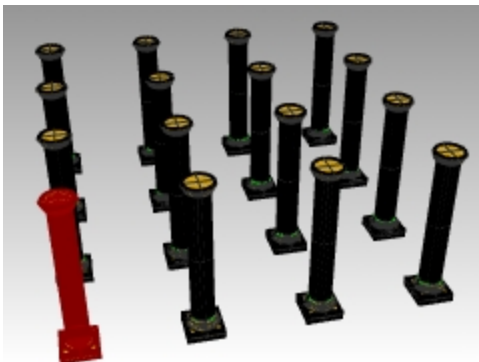

- At this stage you can change the number in each direction or the spacing.  
If you need to make a change, click the option in the Command line and then make the adjustment.

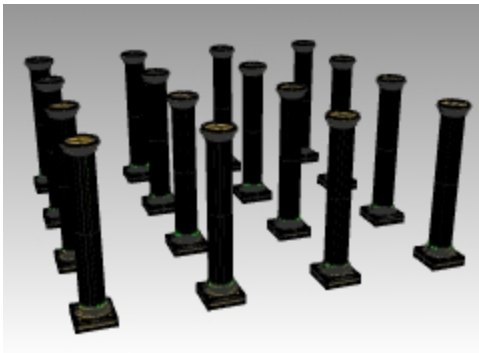

- Press **Enter** to accept.
- Turn on all the layers to see the result.

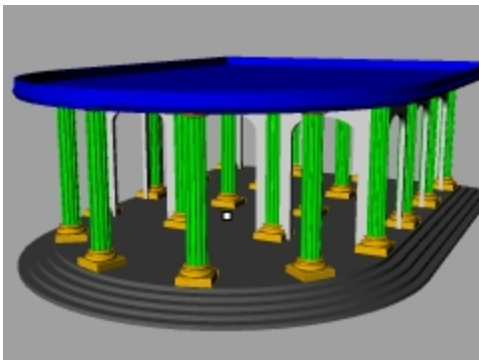

**On your own:** Experiment with additional array commands like Array Linear and Along Curve.

## Exercise 7-12 Practice - The Gasket

In all these practice models, you should separate the geometry into respective layers like: Construction Lines, Object Lines, Dimensions, and Text.

**Hint:** The **Curve Boolean** command can help clean up this geometry with just a few picks.

1. Start a new model, use the **Small Objects - Inches.3dm** template. **Save as Gasket1.**

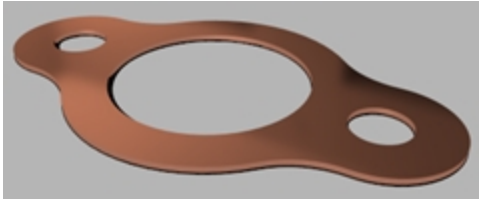

2. Use **Circle**, **Arc**, **Trim**, **Fillet**, and **Join** to create the part shown.

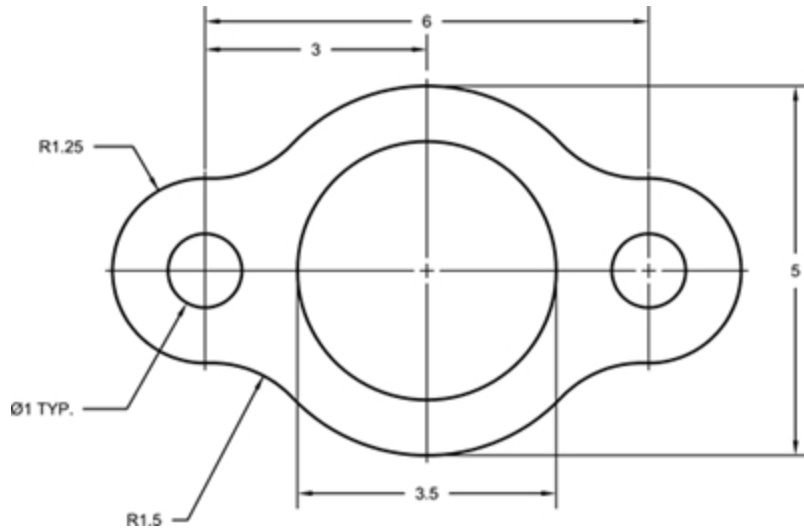

3. On the **Solid** menu, click **Extrude Planar Curve**, and then click **Straight** to create the 3-D part.
4. Set the extrusion thickness to **0.125**.

## Exercise 7-13 Practice - The Cam

1. Start a new model, use the **Small Objects - Inches.3dm** template.
2. Save as **Cam**.



- Use **Circle**, **Arc**, **Line**, **Trim**, **Join**, and **Polar Array** to draw the part shown.

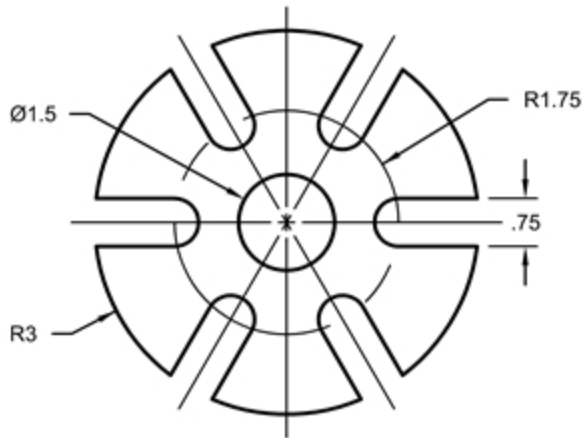

- On the **Solid** menu, click **Extrude Planar Curve**, and then click **Straight** to create the 3-D part.
- Set the extrusion thickness to **0.5**.

### Exercise 7-14 Practice - The Link

- Start a new model, use the **Small Objects - Inches.3dm** template. **Save as Link**.



- Use **Line**, **Arc**, **Trim**, **Offset**, **Join**, **Fillet** and **Circle** to draw the part shown.

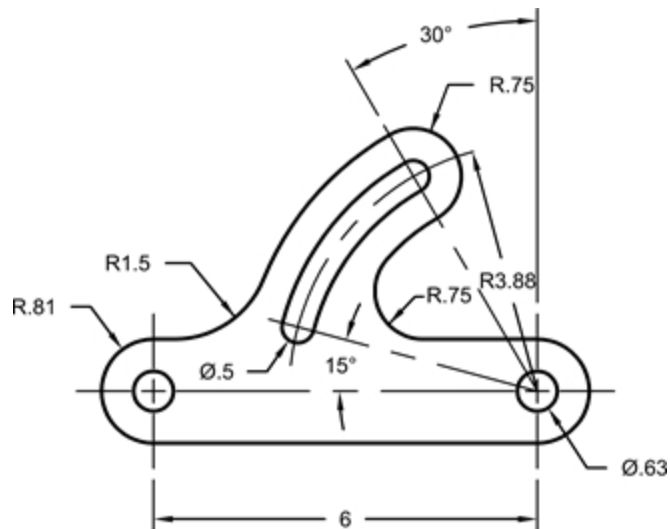

- On the **Solid** menu, click **Extrude Planar Curve**, and then click **Straight** to create the 3-D part.
- Set the extrusion thickness to **0.5**.



# Chapter 8 - Point editing

You can display the control points or the edit points of an object so that you can adjust the shape of an object, rather than manipulating the whole object at once. That is called control point editing.

You can use point editing on meshes, curves, and surfaces, but not on polysurfaces or solids.

Rhino's curves are represented internally with non-uniform rational B-splines (*NURBS*). Three things determine the shape of a NURBS curve:

- A list of points called control points
- Degree
- A list of numbers called knots

If you change any of these things, it changes the shape of the curve.

## About control points, edit points, and knots

- Control points do not have to be on the curve.
- Edit points are always on the curve.
- Rhino lets you edit curves and surfaces by moving control points and edit points.
- Knots are parameters (that is, numbers, not points).
- Adding knots to a curve or surface lets you control the movement of the object during control-point editing.

## Control point editing

In this exercise we are going to experiment with moving control points. Understanding how curves and lines react when control points are moved is very important to understanding NURBS modeling.

### Exercise 8-1 Edit control points

1. **Open** the model **Control Point.3dm**.  
There are pairs of curves with different degrees in the model.
2. Turn **Ortho** and **Grid Snap** on.
3. On the **Edit** menu, click **Select Objects**, and then click **Curves**.
4. On the **Edit** menu, click **Control Points**, and then click **Control Points On** F10.

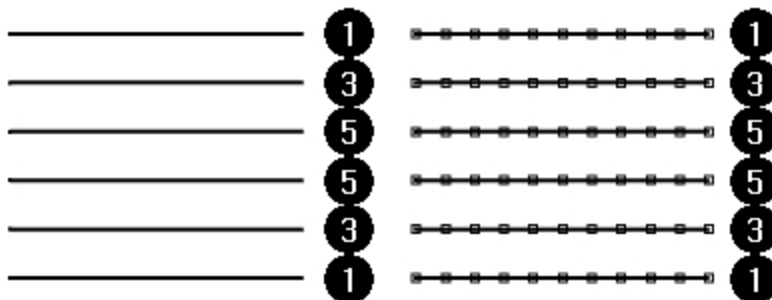

5. In the **Front** viewport, select the middle row of points.
6. Drag the points vertically 8 units.  
Notice that the degree-1 curves (polylines) come to a point at each moved control point and the control points are exactly on the curve.  
The degree-3 and degree-5 curves are smooth. The degree-3 curves have more curvature than the degree-5 curves

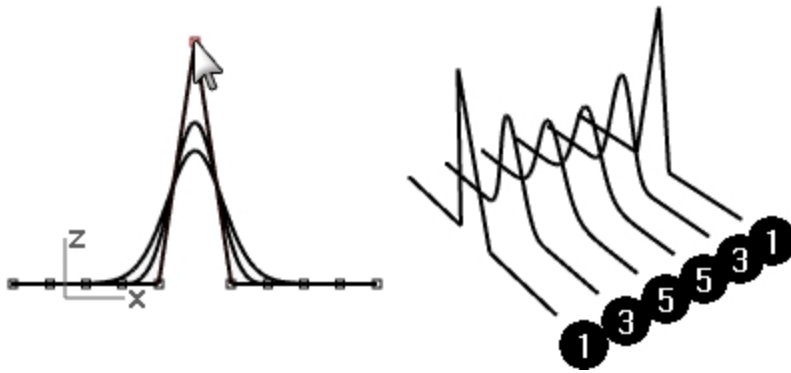

Individual points have more influence on a small area of the curve with degree-3 curves, while points have greater influence over a wider span of the curve with degree-5 curves.

**Check the differences**

1. Turn off the control points **F11** or the **Esc** key.
2. Turn the **Plane** layer on.
3. Select the curves and the plane.
4. On the **Curve** menu, click **Curve** from objects, then click **Intersection**.

Lines are shown on the surface showing the intersections.

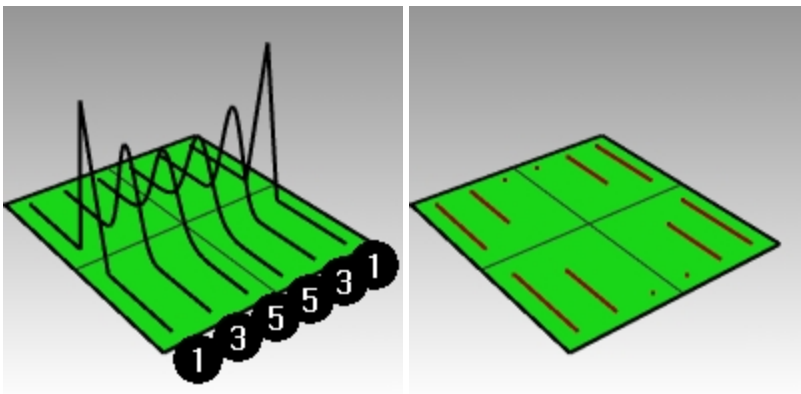

5. Note the difference between the degree 3 and 5 curves.  
 The higher the degree, the greater the influence over the span of a curve, when you edit control points.  
 As you can see by the illustration, editing one point out of 11, on the degree-5 curve, influenced most of the curve. The degree-3 curve has a sharper curvature, because the influence of one point takes place over a shorter span.

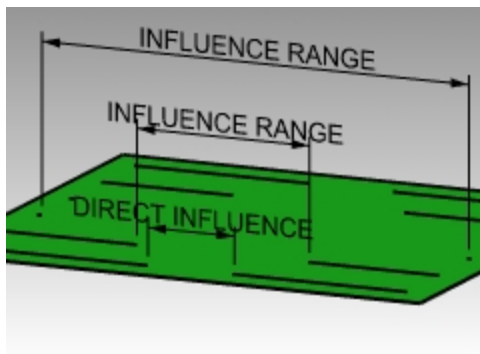

6. **Undo** twice until you get back to seeing just the curves.  
 The intersections will disappear, and the **Plane** layer is off.



### Continue editing control points

1. In the **Front** viewport, select the two rows of points that are three points on either side of the center.
2. Drag the points vertically 5 units.
3. Turn off the control points **F11** or **Esc**.

When a curve or polyline bends sharply at a point, it is called a kink.

If you create a surface from a curve that has a kink, it will have a seam at the kink.

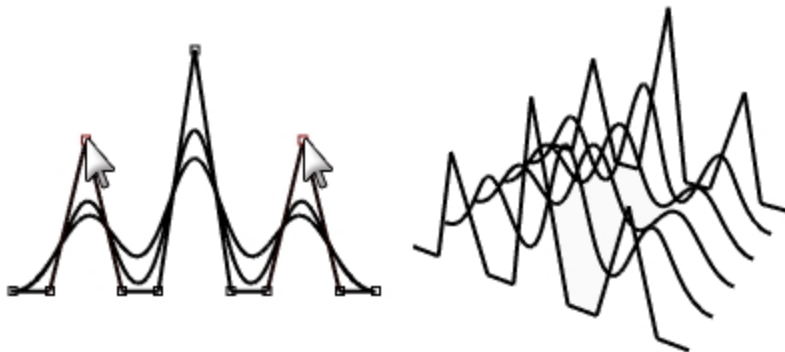

### Make a lofted surface

1. Select the curves.
2. On the **Surface** menu, click **Loft**.
3. In the **Loft options** dialog box, click **OK**.  
Because the degree-1 curves were included in the loft, a polysurface is created with a seam at each kink.
4. Select the surface.
5. **Turn on** the **control points** **F10**.  
The points do not turn on and the following message is displayed in the Command line: "Cannot turn on points for polysurfaces."
6. **Undo** the loft.

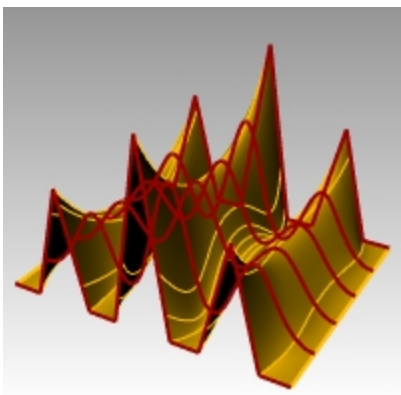

### Change the polylines into curves without kinks

1. Select both polylines.
2. On the **Edit** menu, click **Rebuild**.
3. In the **Rebuild** dialog box set the **Point count** to **11** and the **Degree** to **3**, and click **OK**.  
A degree-3 curve cannot have kinks. The curve smooths and changes shape.

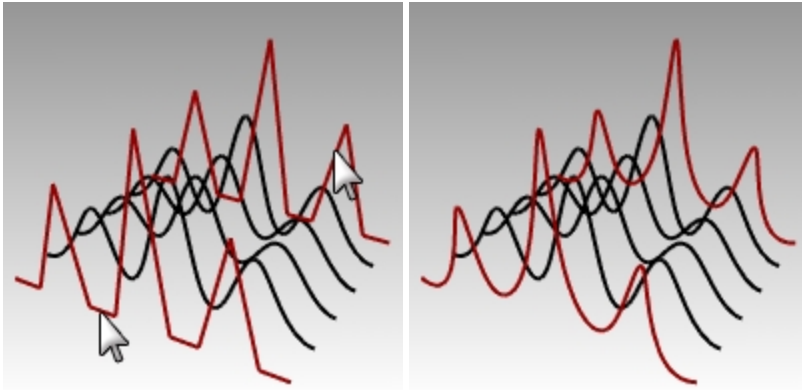

### Loft a surface over the curves

1. Select all of the curves.
2. On the **Surface** menu, click **Loft**.
3. In the **Loft Options** dialog box, click **OK**.  
A single surface appears over the curves. The surface can be edited with control points.
4. Select the surface.
5. **Turn on** the **control points** **F10**.  
Note that there are more control points than what you started with. Rhino adds control points to make the surface conform the original curves.

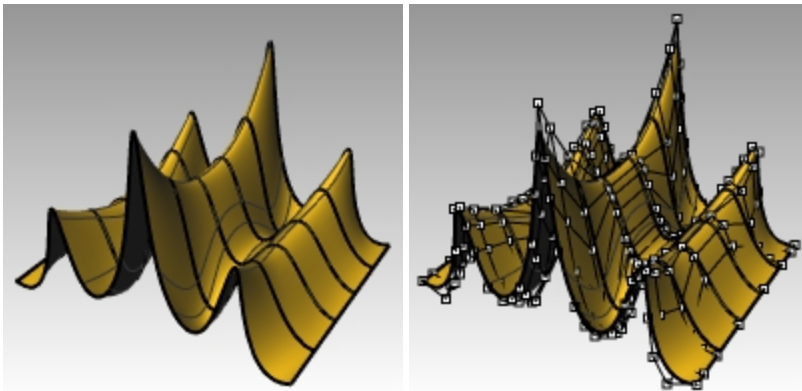

### Rebuild a surface

1. Turn off the control points **F11** or **Esc**.
2. Select the surface.
3. On the **Edit** menu, click **Rebuild**.
4. In the **Rebuild Surface** dialog, change the **point count** to **8** in **U** direction and **13** in the **V** direction.
5. Change the **Degree** to **3** for both **U** and **V**.

6. Check **Delete input**.

The surface is smoother with fewer control points.

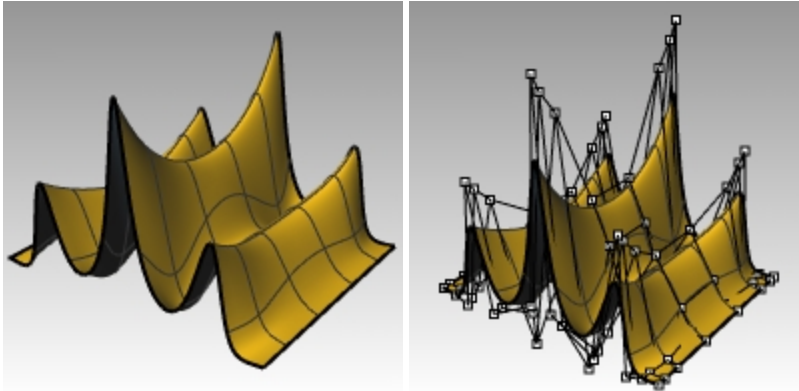

## Nudge Controls

Another method to move control points and other geometry in a more subtle way is to use the Nudge keys. The nudge keys are the arrow keys on the keyboard activated with the **Alt**, **Alt+Ctrl**, and **Alt+Shift** keys.

### Exercise 8-2 Change the nudge settings

1. On the **Tools** menu, click **Options**.
2. In the **Options** dialog box, on the **Modeling Aids** page, note the **Nudge** settings. Any of these values can be changed.

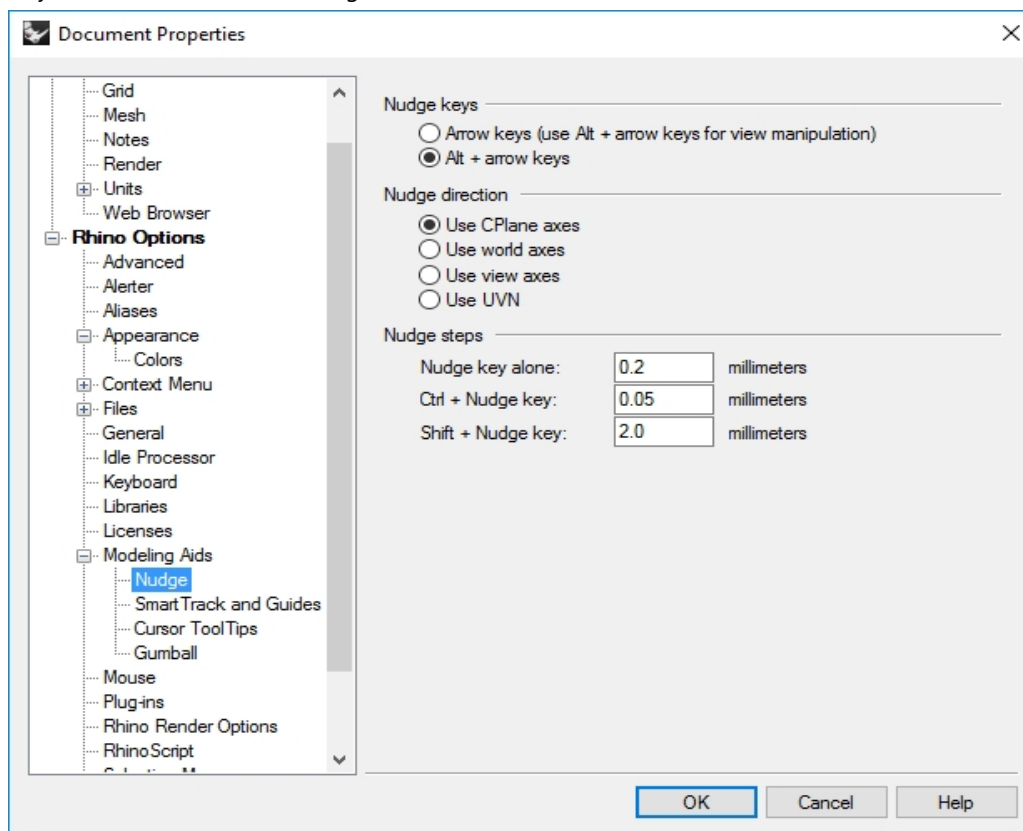

#### Use Nudge keys to move control points

1. In the **Front** viewport, select one or two control points.
2. Hold the **Alt** key down, and press an Arrow key.  
The control points move (*nudge*) a small amount.

3. Hold the **Alt** and the **Ctrl** key down and press another Arrow key.  
The movement is much smaller.
4. Hold the **Alt** and the **Shift** key down and press another Arrow key.  
The movement is magnified.

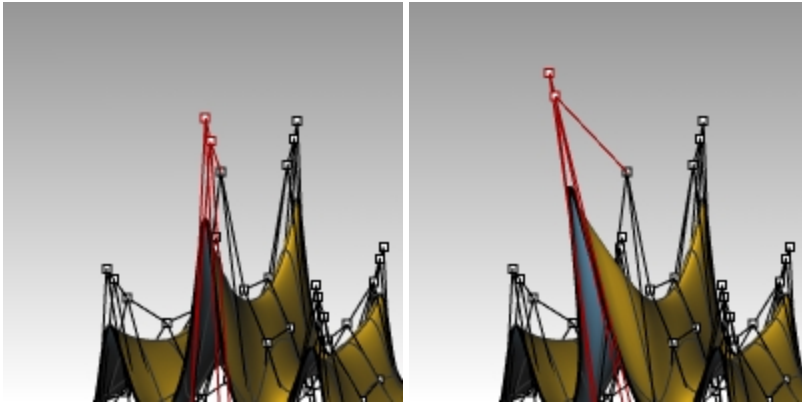

5. Hold the **Alt** and press the **Page Up** or **Page Down** key to nudge in the construction plane z-direction.

### Use Set X, Y, Z coordinates to adjust points

1. Select all the points in one row along the top of the surface.
2. On the **Transform** menu, click **Set X, Y, Z coordinates**.
3. In the **Set Points** dialog box, check **Set Z**, and clear the **Set X** and **Set Y** check boxes.

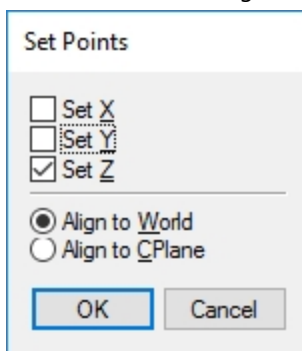

4. In the **Right** viewport, move the points and click.  
The control points are aligned in the world z-direction.
5. Repeat this on some of the other rows of points.

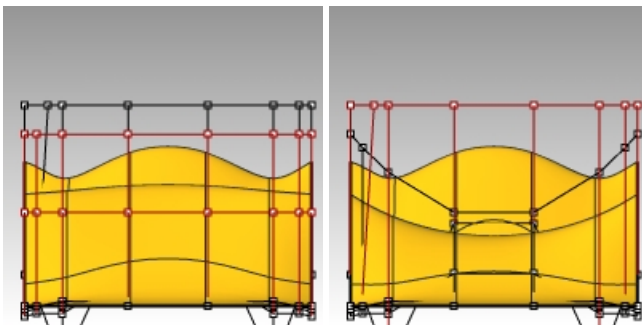

### Use Gumball to move control points

You can use the gumball to move, rotate and scale control points, in a very similar way as you were able to transform objects. Let's look at moving the control points with the gumball.

1. Select the surface.
2. On the **Edit** menu, select **Control Points**, and then **Control Points On** **F10**.

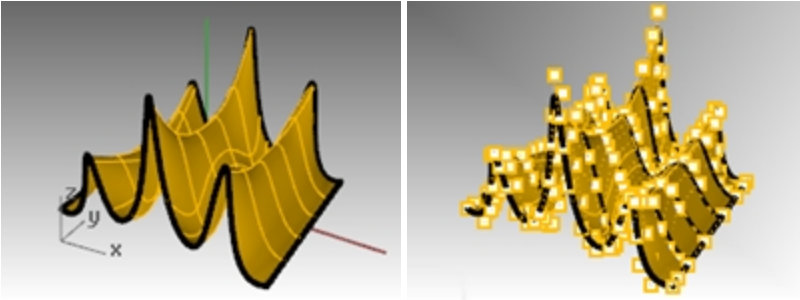

3. Turn on **gumball**, and select the points in one row along the top of the surface.

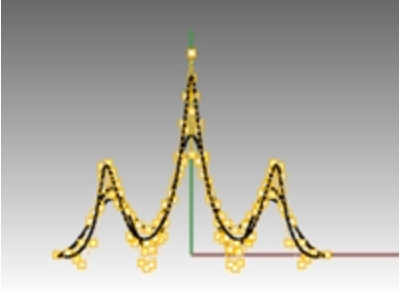

4. In the **Front** viewport, **window select** points as shown.

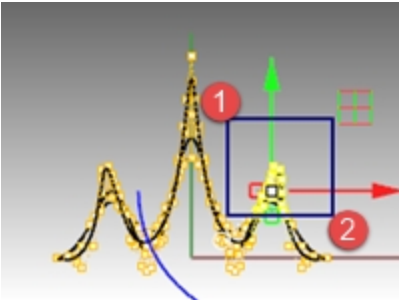

The points along the top row are selected.

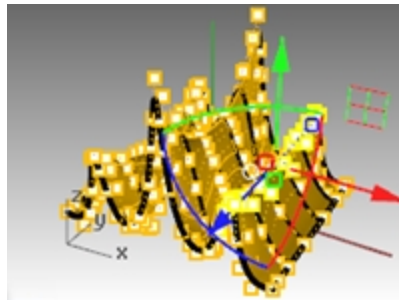

5. In the **Front** viewport, select the **green gumball arrow**, drag up and pick.  
The points move up.

- In the **Front** viewport, select the **red gumball arrow**, drag to the right and pick. The points move to the right.

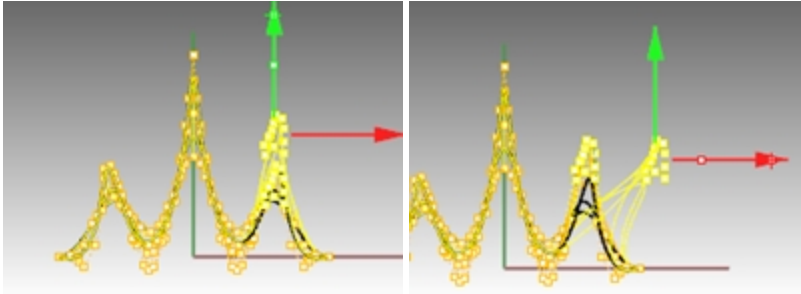

- In the **Front** viewport, pick the **green gumball arrow**, drag down and pick. The points in the top rows move down.

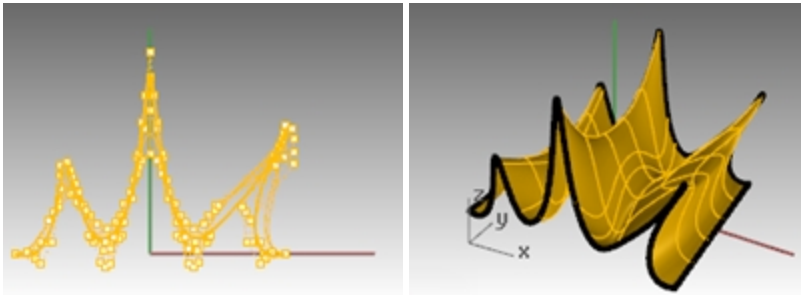

- Press **Esc** to unselect points.
- Use the gumball for control point editing whenever possible in the next few exercises.

### Exercise 8-3 Practice with curves and control point editing

The Glass model contains a picture frame of a glass profile. Use the **Curve** command to trace the profile and revolve into a surface. If the curve and the axis of rotation form a closed area, then the result of the revolution will be closed. If the curve that you revolve is smooth with no kinks, then the result of the revolution will be a closed surface, not a closed polysurface. This is important if you want to control point edit the surface into a fluted shape.

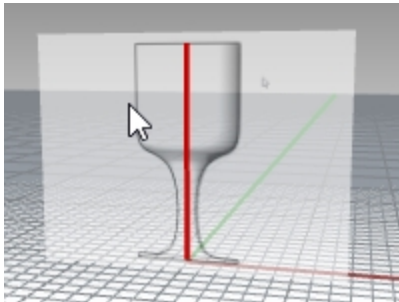

- Open model **Glass.3dm**.  
Glass model is in Inch units. If you prefer MM, then change the Model units in **Options** off the Units page. When prompted to scale the model by the conversion factor of 25.4, pick **yes**. Now you may continue with this exercise in your preferred unit. (Discuss options with your instructor or reference the Help.)
- Make the **Profile\_curve** layer current.
- Use the **Curve** command to create a half cross-section of the glass. (The red center line marks the center of the glass.)
- Use control point editing to adjust the curve until you get the desired shape.

**Make it 3-D**

1. Select the curve you created.
2. On the **Surface** menu, click **Revolve**.
3. For the **Start of revolve axis**, pick one end of the curve.

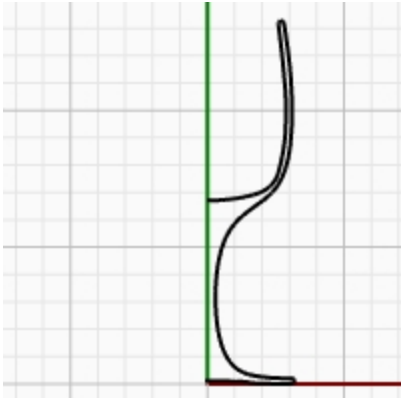

4. For the **End of revolve axis**, pick the other end of the curve.
5. For the **Start Angle**, click **Deformable=Yes**.  
This changes the structure of the revolved surface to make it easier to deform without creating kinks.
6. For the **Start Angle**, click **FullCircle**.



7. **Save** your model.
8. Experiment with adjusting the control points to see what happens.

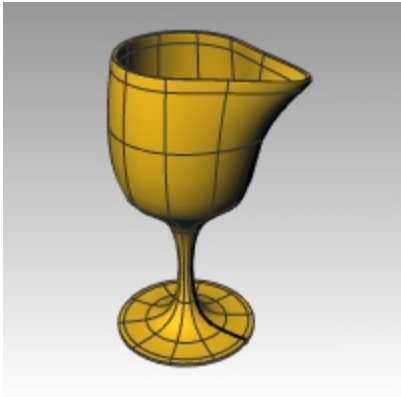

9. From the **Edit** menu, Undo to return the glass to the symmetrical shape.



### Fluted The Glass

---

1. To flute the glass you just made, turn on the control points for the surface.
2. In the **Top** viewport, with the **Lasso** command, select every other radial grouping of control points. **Enter** at the end of each grouping, and **Enter** to repeat the **Lasso** command. This will keep the commands repeating efficiently.

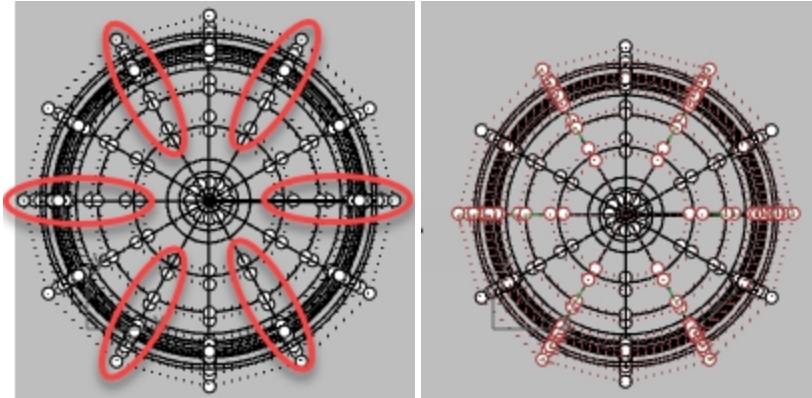

3. Pick Scale 2D from the **Transform** menu.



- At the **Base Point** prompt, in the **Top** viewport, pick at the center of the glass with the End point osnap.

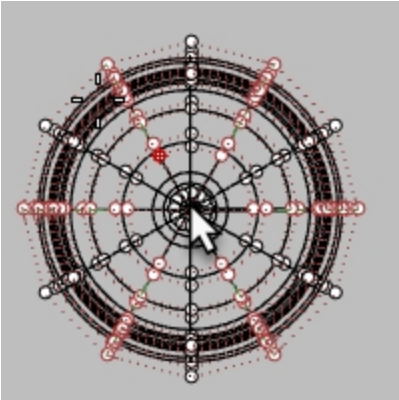

- At the **Scale factor or first reference point** prompt, pick off to the right or left.  
**Hint:** If Ortho is off, hold down the **Shift** key while picking.

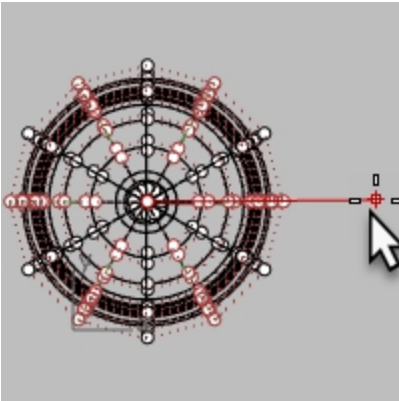

Isocurves will appear in a star shape while picking.

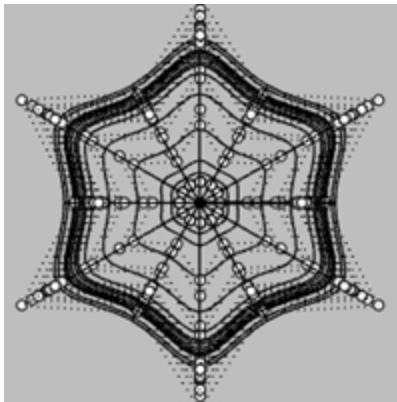
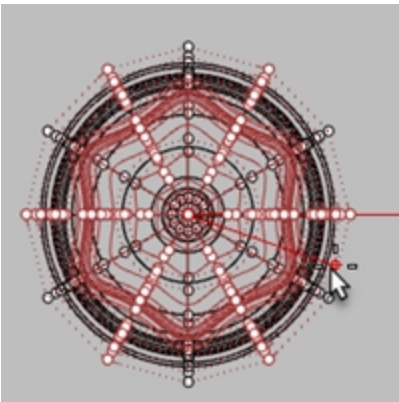

6. View the model in Shaded and Ghosted display modes.



*Shaded and Ghosted display modes.*

7. **Save** your model.

# Chapter 9 - Creating Deformable Shapes

---

When building models in Rhino, you should first determine which methods should be used for each part of the project. There are two basic ways to model in Rhino—free-form and accurate. Some models require more attention to exact dimensions because they might have to be manufactured or parts may have to fit together. Sometimes it is the shape of the object, not the accuracy that is important. These techniques can be merged together to create accurate, free-form shapes. This tutorial focuses only on the free-form, squishy aspect. The exact size and placement of the objects is not critical. The overall form is the main objective.

## Exercise 9-1 The Rubber Duck

---

This exercise shows:

- Simple surface creation
- Surface rebuilding
- Control point editing
- Curve creation ( drawing, projecting )
- Splitting surfaces with curves and surfaces
- Blending between two surfaces
- Lighting and rendering

When you model the rubber ducky, you will use similar modeling techniques for the head and the body.

You will create spheres that will be deformed to make the shapes.

If you need to know more about control points and surfaces, search the Rhino Help index for “control points.”

### Start the model

---

1. Start a new model using the **Small Objects - Millimeters.3dm** template.
2. Save as **Duck**.
3. You can use layers to separate your parts, but for this model, it is not necessary.



### Create the body and head shapes

The body and head of the ducky are created by modifying two spheres. The size and placement of the spheres does not need to be exact.

#### Create the basic shapes

---

1. On the **Solid** menu, click **Sphere**, and then click **Center, Radius**.
2. In the **Front** viewport, pick a point to specify the center of the sphere.  
Or you can type **0** and **Enter** to locate the center of the sphere at the origin of the Front construction plane.
3. Next, in the **Front** viewport, to specify the sphere radius, pick a second point to the left of the center point.  
This will locate the seam of the surface to the left side of the sphere. Later in the exercise when trimming the neck

and beak, you will see the advantages.

**Note** Toggle Ortho on with the **Shift** key.

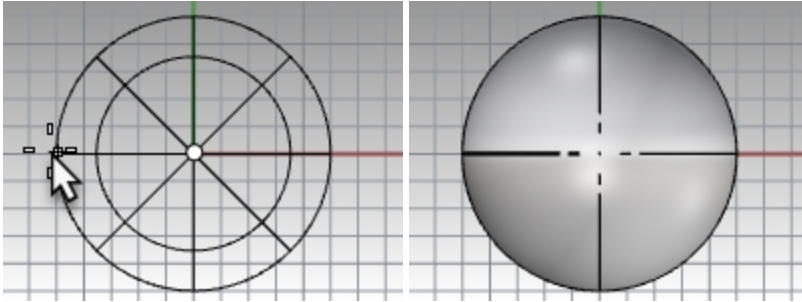

4. Repeat this procedure for the second sphere, also pick to the left of the center point.

**Note:** The seam will appear thicker than the isocurves. Verify the seam location to the left side of the sphere.

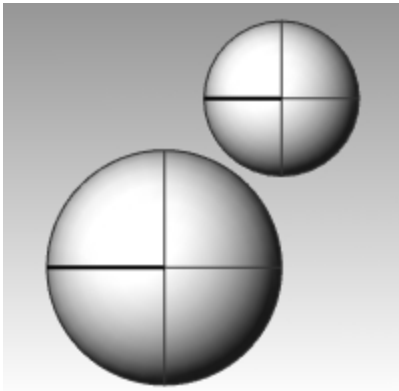

### Make the spheres deformable

---

1. Select both spheres.

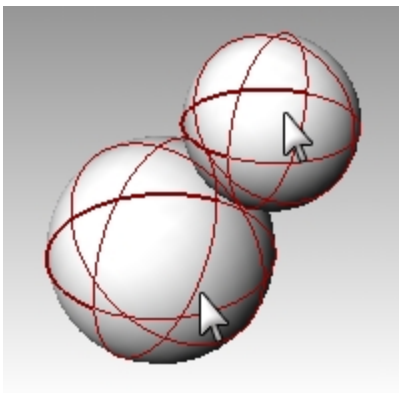

2. On the **Edit** menu, click **Rebuild**.
3. In the **Rebuild Surface** dialog box, change the **Point Count** to **8** for both **U** and **V**.
4. Change the **Degree** to **3** for both **U** and **V**.

5. Check **Delete Input**, clear **Current Layer**, and click **OK**.

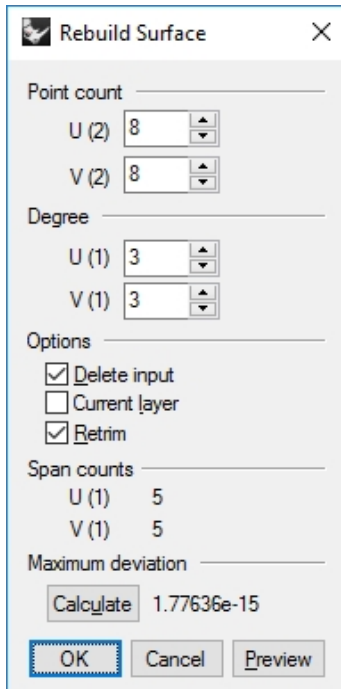

The spheres are now deformable. Having more control points allows more control over smaller parts of the surface. A degree-three surface will have a smoother shape when deformed.

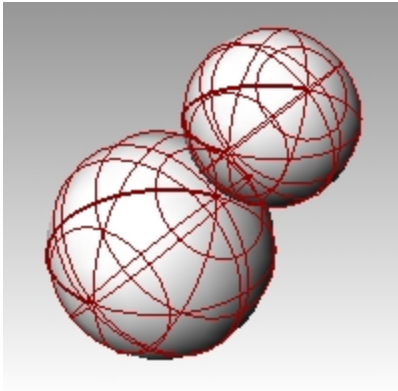

### Modify the body shape

1. Select the large sphere.
2. On the **Edit** menu, click **Control Points**, and then click **Control Points On**.
3. In the **Front** viewport select the control points near the bottom of the sphere.  
To window select, drag a rectangle left to right around the control points.
4. On the **Transform** menu, click **Set X, Y, Z coordinates**.
5. In the **Set Points** dialog box check **Set Z**, and **Align to World** as illustrated above.

6. **Drag** the selected control points up, snap to one of the upper most selected points. This aligns all of the selected control points to the same world z-value (vertical in **Front** viewport), flattening the surface.

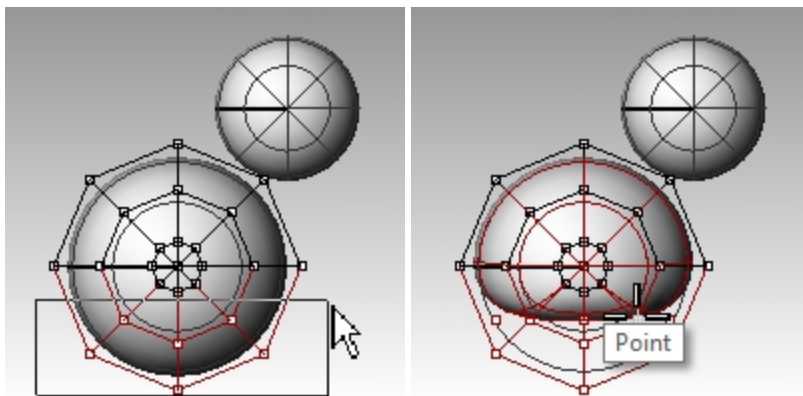
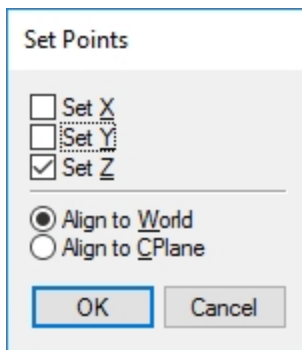

### Scale the sphere shape

1. Turn off control points and select the body shape.
2. On the **Transform** menu, click **Scale**, and then click **Scale 1-D**.
3. For the **Base point**, pick a point near the center of the body sphere.
4. For the **First reference point**, with **Ortho** on, in the **Front** viewport, pick a point to the right.
5. For the **Second reference point**, in the **Front** viewport, pick a point farther to the right.

The body is shaped like an ellipsoid.

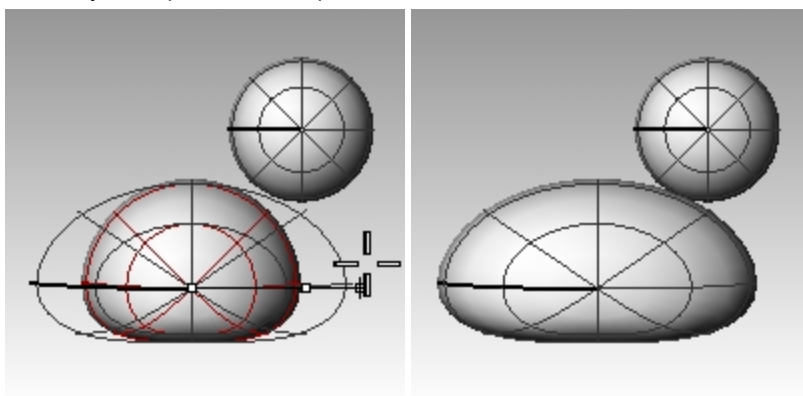

## Reshape the chest and tail

1. Turn the control points on **F10**.
2. Window select the control points at the top right of the body, and drag them to the right to bulge out the chest.

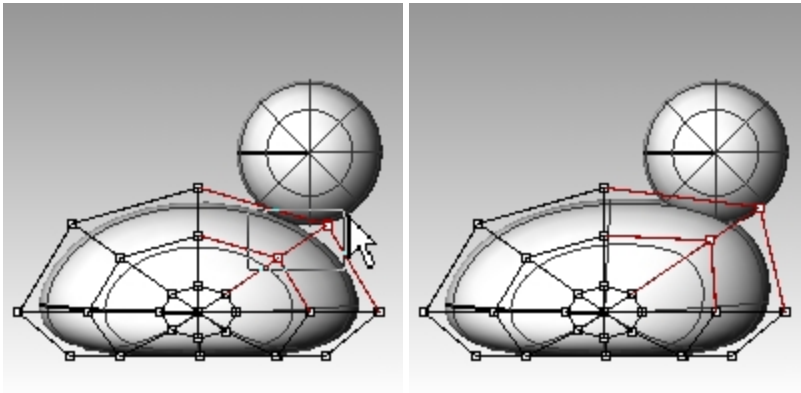

3. Window select the control points at the upper left edge of the body, and drag them up to form the tail. Notice in the **Top** viewport that two control points are selected, though in the **Front** viewport, it looks like only one is selected. This is because the second control point is directly behind the one you can see in the **Front** viewport.

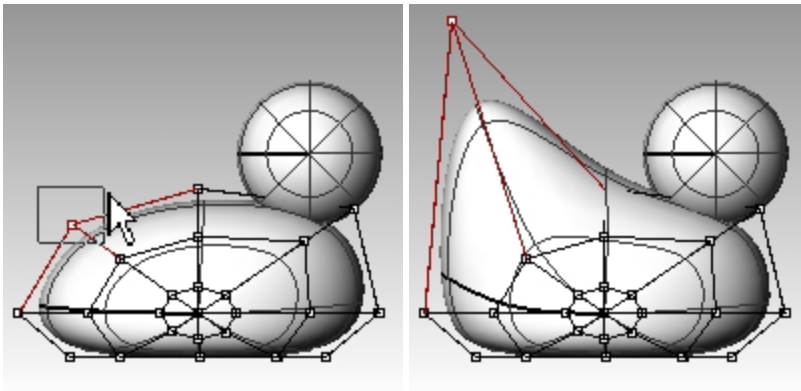

## Add control for further shaping the tail

Before we start to edit the tail further, we will add an additional set of points to the tail portion of the body.

1. On the **Edit** menu, click **Control Points**, and then click **Insert Knot**.
2. For the **Surface for knot insertion**, pick the body surface.  
A surface isocurve will be displayed. It will either be in the U or the V direction.
3. **Flip** the direction if necessary.
4. For the **Point on surface to add knot**, pick a point midway between the tail and the center of the body.

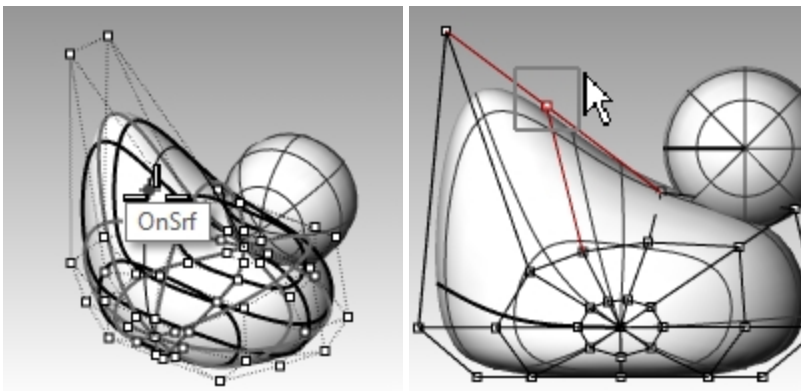

5. Press **Enter** to end the command.  
A new set of isocurves and a new row of points have been added to the body.

6. **Window select** the control points at the upper part of the new isocurve, and drag them down to further form the tail and the body.
7. Adjust the control points further until you get the shape you want.

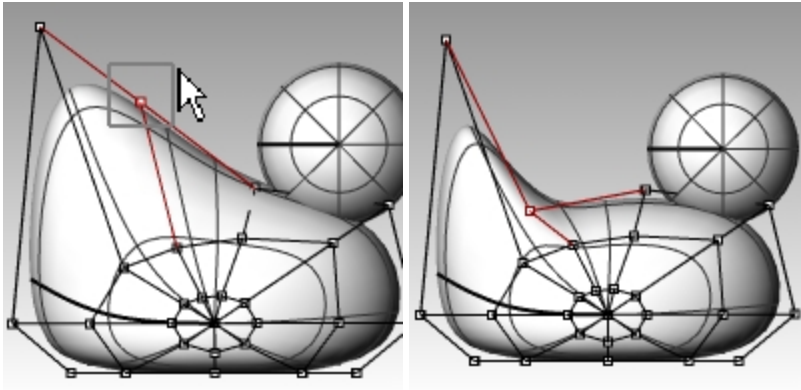

8. **Save** your model.

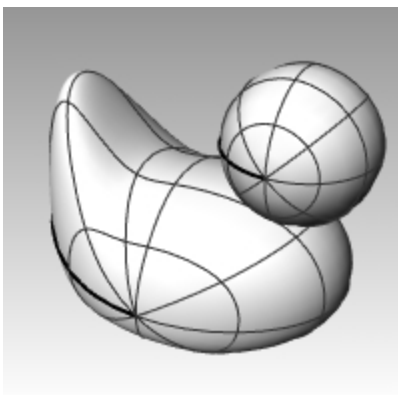

### Create the head

1. In the **Front** viewport, select the small sphere.
2. Turn **Control Points On** (F10).
3. Select the control points on the right side and drag them to begin forming the bill.

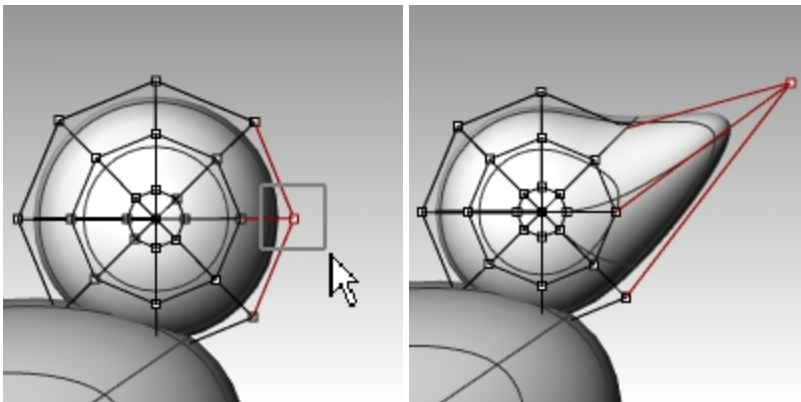



4. **Window select** the control points further back on the same isocurve and drag them forward to widen the bill. There may be multiple control points in the same location in this view.

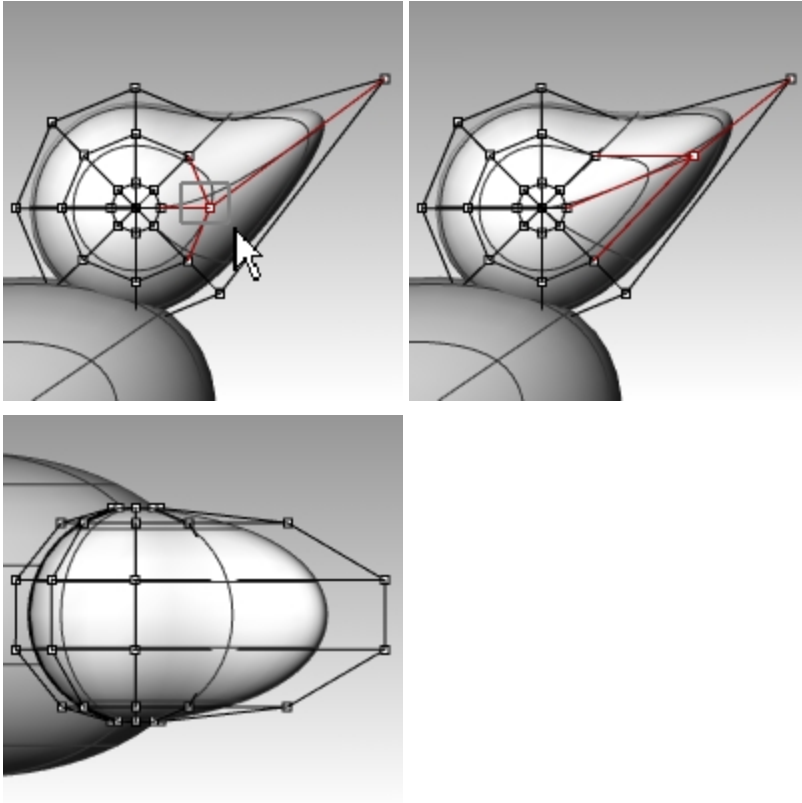

5. **Window select** control points at the top of the bill and drag them down as shown.
6. Press **F11** or **Esc** to turn control points off.

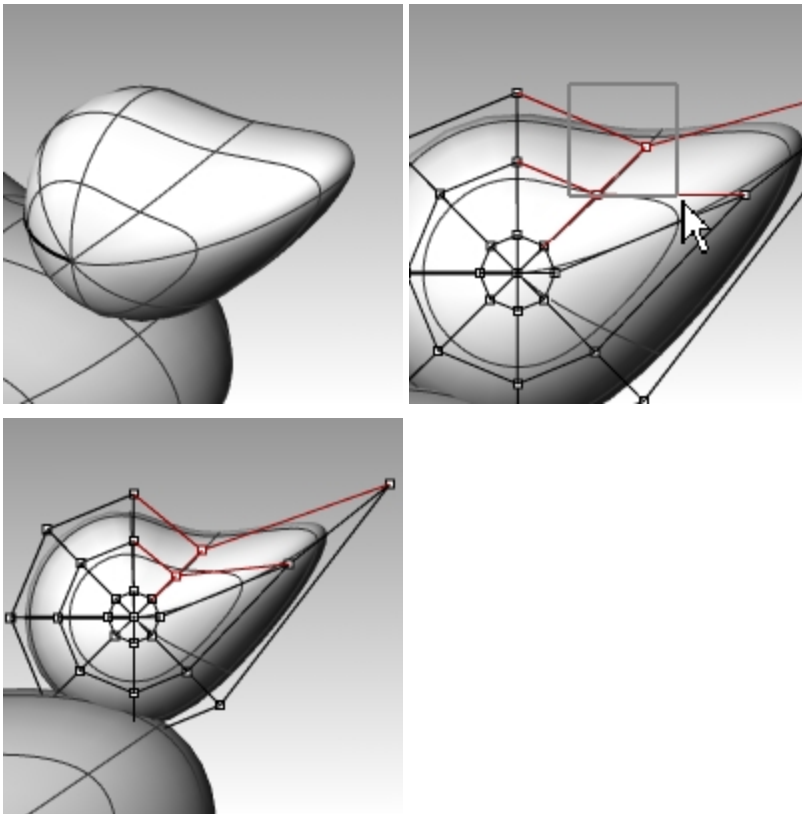

## Separate the bill from the head

For the final rendering, the bill must be a different color from the body. To do this, they must be separate surfaces. You can split a single surface into multiple surfaces many ways. The following technique is just one.

### Split a surface with a curve

---

1. In the **Front** viewport create a curve that looks like the illustration.

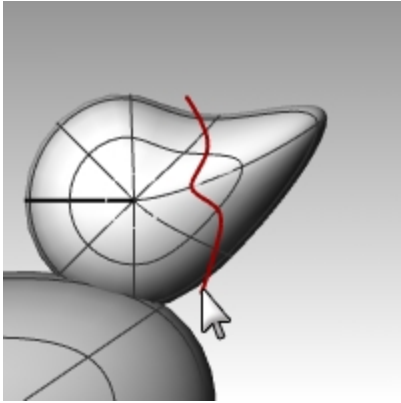

2. Select the head.
3. On the **Edit** menu, click **Split**.
4. For the **Cutting object**, pick the curve you just created, and press **Enter**.  
The bill and head are now separate surfaces. This will allow you to render the surfaces with different colors.

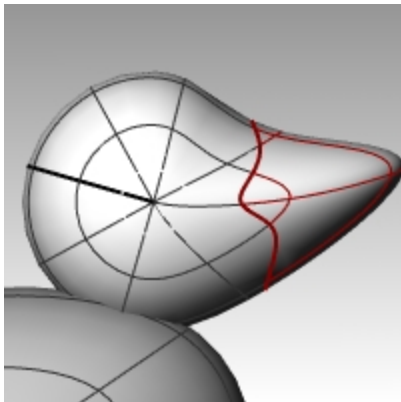

## Create the duck's neck

The ducky needs a neck. You will first make an edge on the surface of the head and a corresponding edge on the surface of the body so you can create a blended surface between the two edges.

### Trim the head and the body

1. Draw a Line across the bottom of the head.
2. **Copy** the line and adjust it so that it intersects the top of the body as illustrated on the right. It is important that the lines intersect the bottom of the head and the body completely.

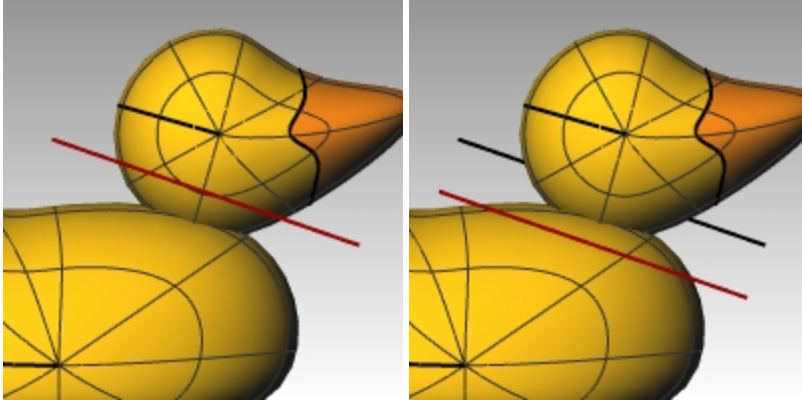

3. Select the lines.
4. On the **Edit** menu, click **Trim**.
5. For the **Object to trim**, pick the bottom of the head and the top of the body. The bottom of the head and the top of the body is trimmed.

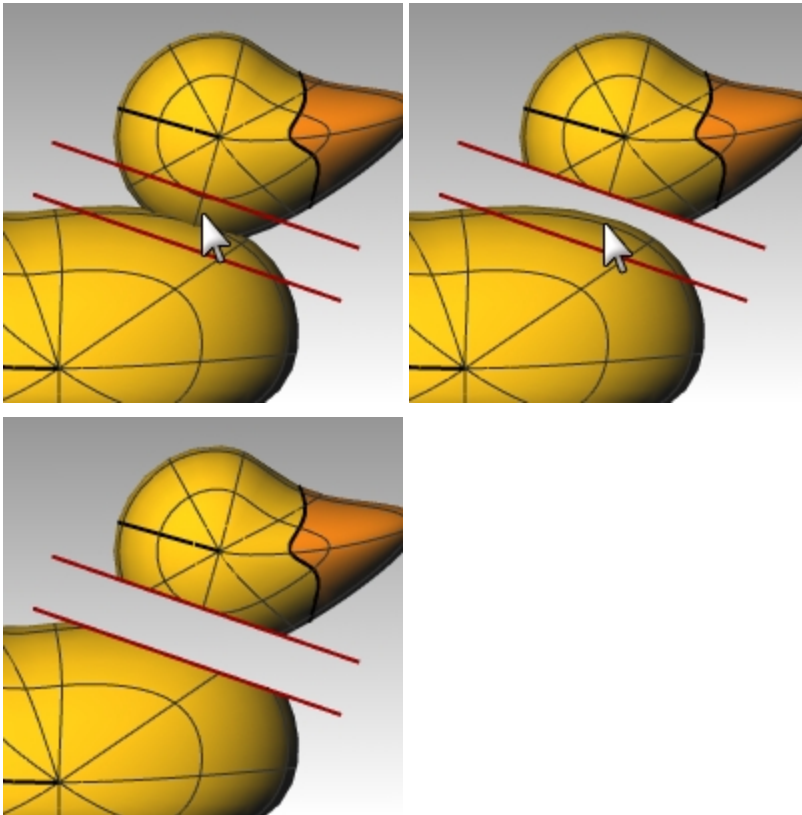

6. **Save** your model.

### Create the blend surface between the head and body

1. On the **Surface** menu, click **Blend Surface**.
2. For the **Segment for first edge**, pick the edge curve at the bottom of the head.
3. For the **Segment for second edge**, pick the edge curve at the top of the hole in the body.

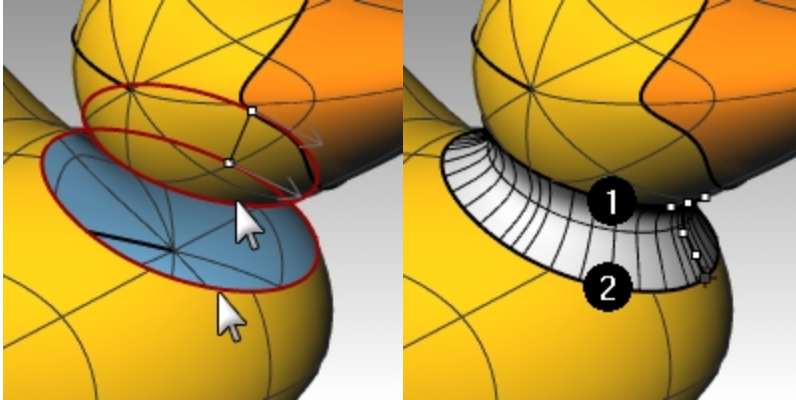

4. Make any adjustments you desire by moving the slider bars in the dialog box, click **OK** when finished. If you click the lock icon at the left of the sliders the surface adjustments are symmetrical.

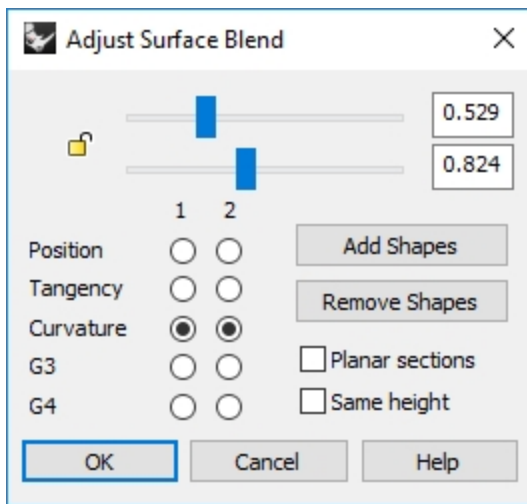

5. **Save** your model.

**Note:** In Rhino 6, the **BlendSrf** command supports **History**.

Undo the last **BlendSrf**, and redo with **Record History** in the Status bar enabled. A blend that is created with **Record History** enabled will react when the input surfaces are moved or rotated. This can be helpful in choosing the best distance for the head of the duck to be located from the body

### Join the parts

1. Select the body the blend surface and the back of the head.
2. On the **Edit** menu, click **Join**.  
The three surfaces are joined into one. The bill is left separate for rendering purposes.

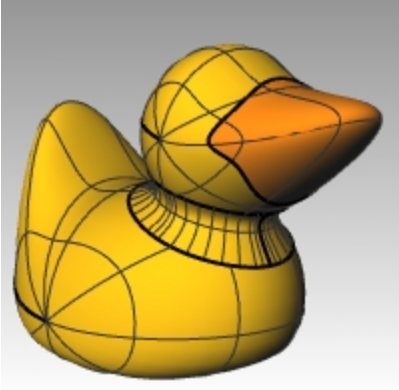

### Make an eye

For this part of the exercise we will make a curve and revolve it to get the surfaces for the eye.

1. Toggle **Grid Snap** on to assist with the point placement.
2. On the **Curve** menu, click **Conic**.
3. In the **Front** or **Right** viewport make a conic curve as illustrated.  
Start of Conic (1), End of Conic (2), Apex (3), Curvature point.

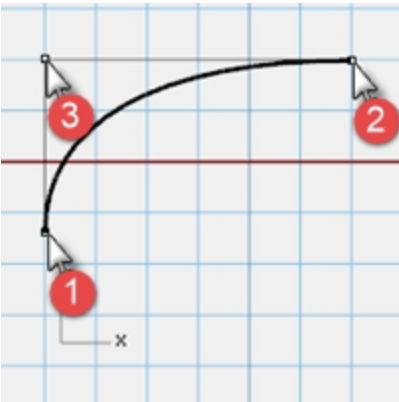

4. Use **SmartTrack**, with **Point**, **End** and **Int** object snaps on, to help place the two points as illustrated.  
These points will be used for placement of the eye on the head.

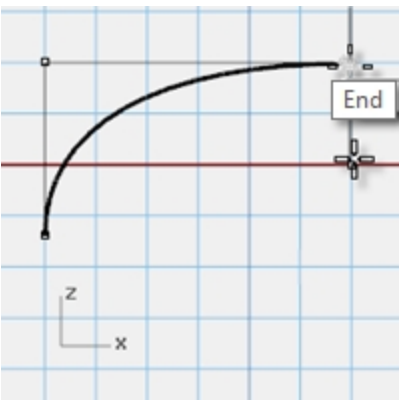

5. On the **Curve** menu, click **Point Object**, then click **Multiple Points**.
6. For the **Location of point object**, hover over the end of the conic until the point activates, drag you cursor down and click to place the point.

The point should be placed above the lower end of the conic.  
This will be the insertion point for eye.

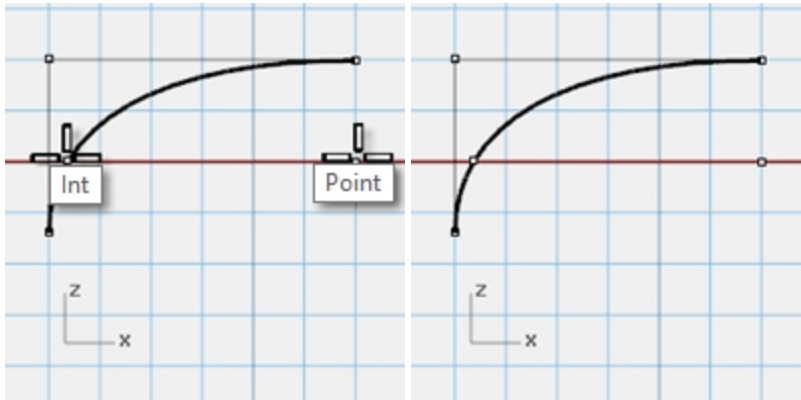

7. For the **Location of point object**, hover over the point you just made until the point activates, drag your cursor left and click when you reach the intersection point.  
This point is for scaling and rotating the eye.

### Split the curve

1. Draw a line that intersects the conic curve.
2. Select the conic curve.
3. On the **Edit** menu, click **Split**.
4. For the **Cutting** object, select the **line**.

Splitting the curve allows you to assign a different color and material properties for the eye and the pupil.  
This step can be done at this stage or after you make the surface.

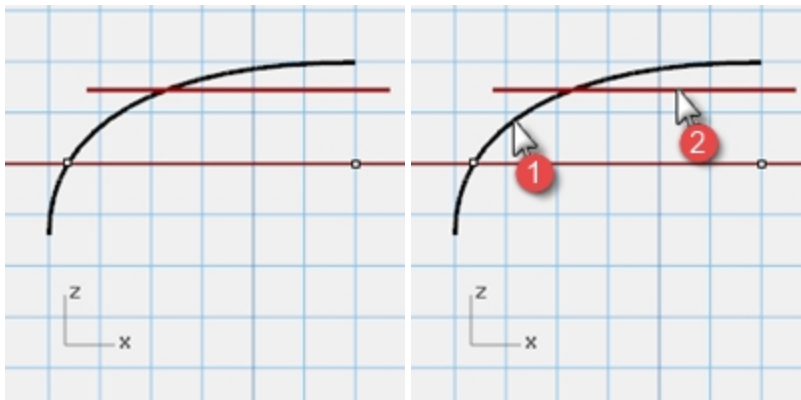

### Make the surface

1. Select both parts of the conic curve.
2. On the **Surface** menu, click **Revolve**.
3. For the **Start of revolve axis**, snap to the point.

4. For the **End of revolve axis**, snap to the end of the conic.
5. For the **Start Angle**, click **FullCircle**.

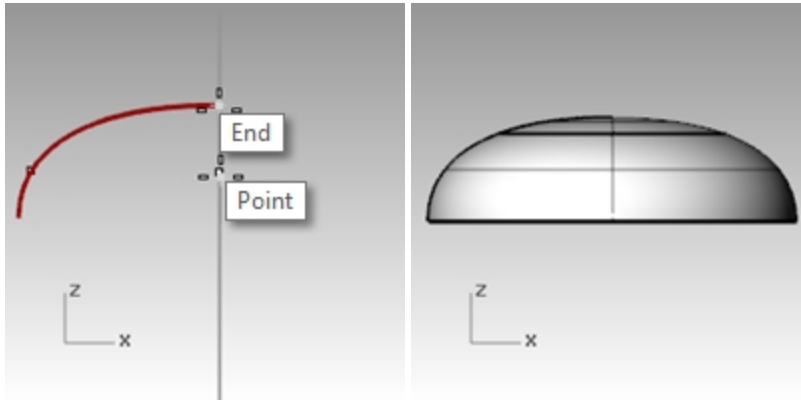

### Assign display color and material color

1. Select the top of the eye.
2. On the **Edit** menu, click **Object Properties**.
3. For the **Display color**, choose a contrasting color, like red.
4. With surface still selected, in the **Properties** pane, select the **Material** page button

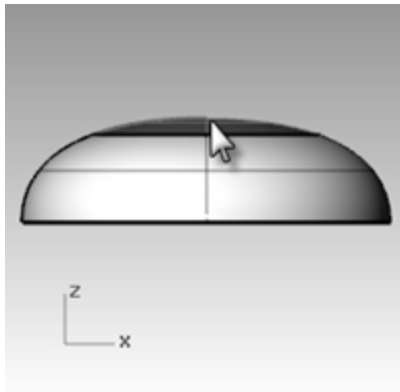

5. In **Materials** select the "+" next to **Use a new material** and select **Plastic** as the new material template.

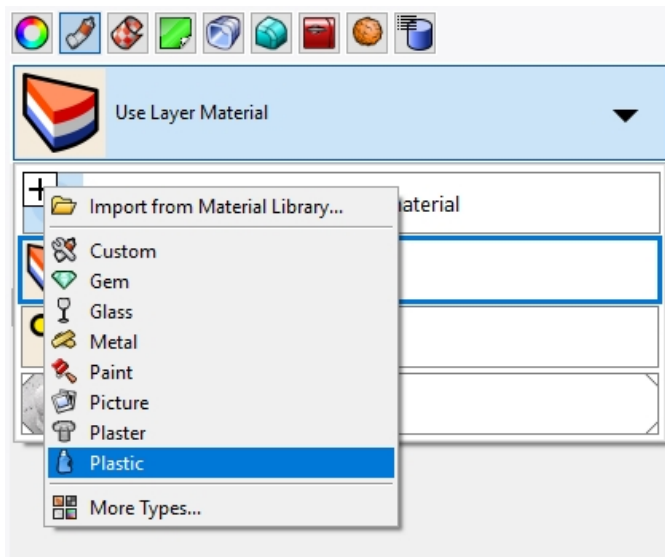

6. Select the **Color** frame and the **Select Color** dialog appears.
7. Select **Black** and click **OK**.

8. Set the **Reflectivity** to **80%**.

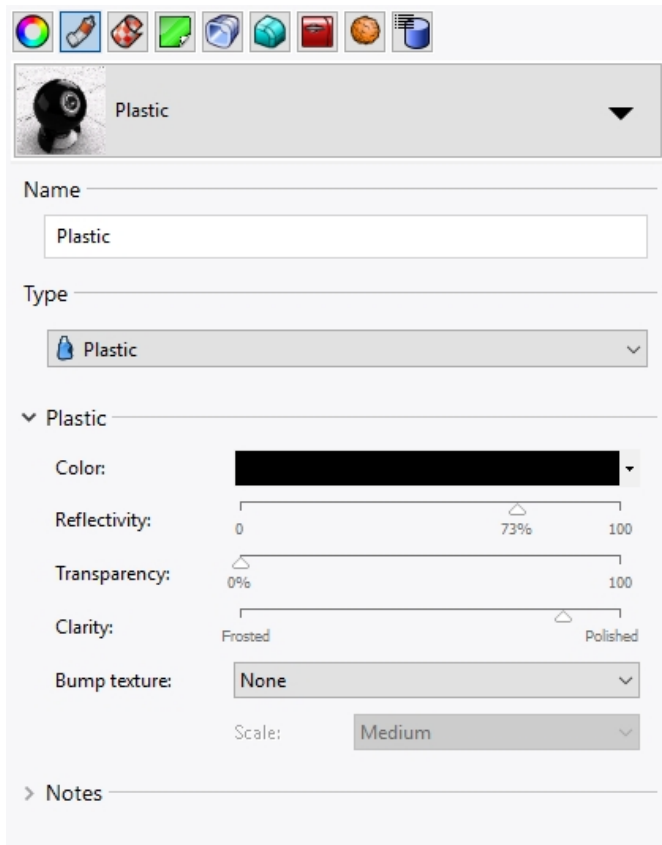

9. Repeat these steps create a white material for the eye.  
 10. On the **Render** menu, click **Render Preview** to see the material color.

### Place the eye on the head

1. In the **Top** viewport, select both parts of the eye.
2. On the **Edit** menu, click **Groups** and then click **Group**.  
The eye parts are grouped as one object.
3. Select the group.
4. On the **Transform** menu, click **Orient**, then click **On Surface**.
5. For **Base point**, snap to the point at the center of the eye.
6. For **Reference point for scaling and rotation**, snap to the point at the edge of the eye.
7. For **Surface to Orient** on, pick the head.

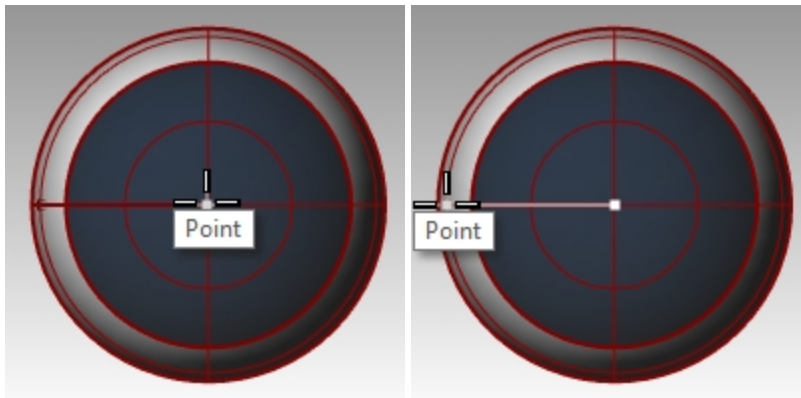



8. In the **Orient on Surface** dialog, for **Scale** check **Prompt** and **Rigid**, click **OK**.

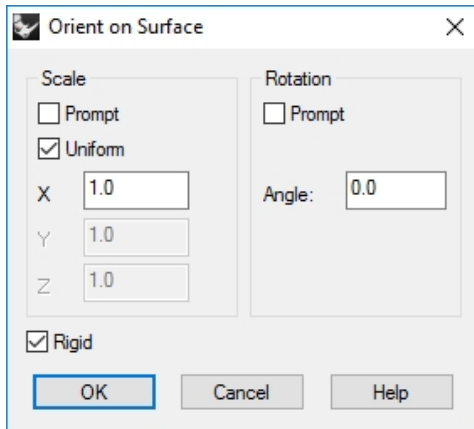

9. For the **Point of surface to orient to**, pick a point on the head.  
 10. For the **Scale factor**, drag your mouse and pick to scale the eye.

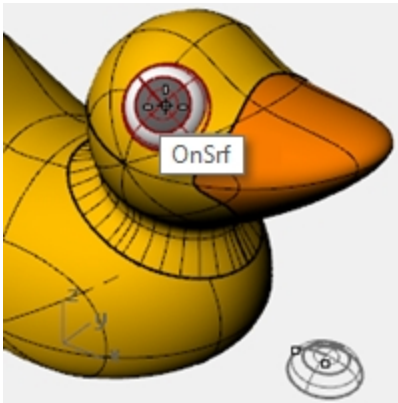

11. **Mirror** the eye to the other side of the head.

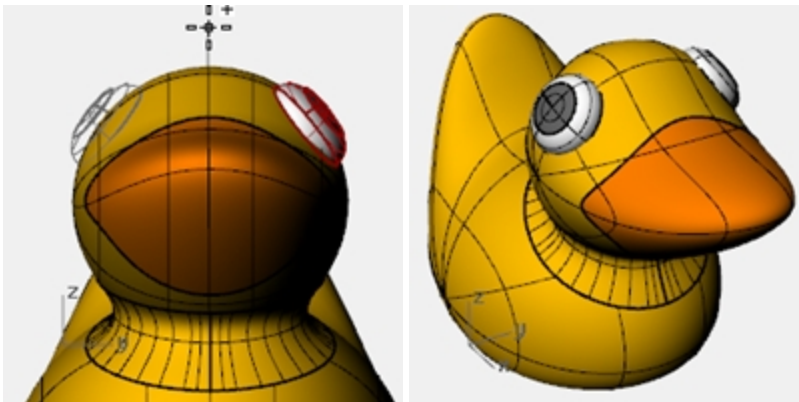

## Render a picture of the ducky

Rendering creates a realistic picture of your model with colors you assign. These render colors are different from the layer colors you might be using, which control the display in wireframe and shaded mode.

### Render the ducky

1. Select the beak.
2. On the **Edit** menu, click **Object Properties**.
3. In the **Properties** panel, on the **Material** page, click and arrow next to **Use Layer Material**, then click the + next to **Use new material**.
4. From the menu, click **Plastic** as the new material template. This will create a new material with presets for plastic.
5. in the **Properties** panel, on the **Materials** page, under the **Plastic** settings, click on the color swatch.
6. In the **Select Color** dialog box, select a color for the beak, like orange. Click OK to close the dialog.

7. Select the body.
8. On the **Edit** menu, click **Object Properties**.
9. In the **Properties** panel, on the **Material** page, click and arrow next to Use Layer Material, then click the + next to **Use new material**.
10. From the menu, click **Plastic** as the new material template. This will create a new material with presets for plastic.
11. Under **Plastic** settings in the Properties panel, click on the color swatch.
12. In the **Select Color** dialog box, select a color for the duck body, like yellow. Click OK to close the dialog.
13. On the **Render** menu, click **Render**.

### Place lights

1. On the **Render** menu, click **Create Spotlight**.
2. Select a point in the middle of the model.

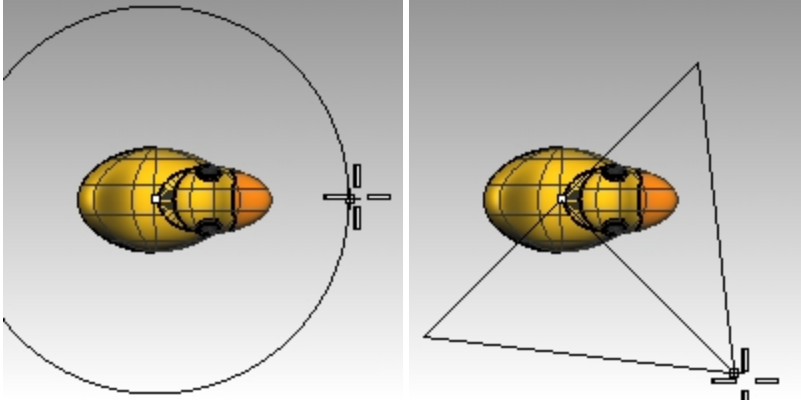

3. **Drag** the radius until it is approximately three times as large as the model.
4. In the **Top** viewport, pick a point while holding the **Ctrl** key down to activate elevator mode.
5. In the **Front** viewport, pick a point slightly above the object.
6. On the **Render** menu, click **Render**.

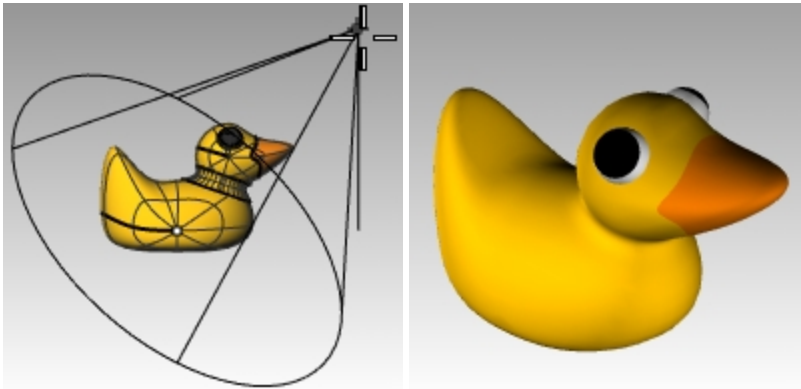

**On your own**

- ▶ Try modeling and rendering a variation of the duck.  
In this image, the duck shape is used for the exterior design of the "Duck Cafe".



*Duck Cafe by Doaa Alsharif*



# Chapter 10 - Modeling with solids

---

Next, you will work with several commands that create and edit solid objects.

- In Rhinoceros, solids are closed surfaces or polysurfaces that enclose a volume.
- Some of the solid primitives are closed single-surfaces carefully edge-matched, others are polysurfaces.
- Rhino's polysurface objects are deformable by using the deformation commands under the **Transform** menu.
- You can also extract surfaces and deform the surfaces with control point editing like the last exercise.

In this part of the training, you will focus on making some solids, separating the parts, making changes and then joining the parts back together to make a solid.

## Exercise 10-1 Model a bar with text

---

In the following exercise we will make a solid primitive, extract some surfaces, rebuild a surface and deform it, join the new surfaces into a solid, fillet the edges, add text to a surface, and do a Boolean operation on the solid.

### Set up the model

---

1. Start a new model using the **Small Objects - Millimeters** template.
2. Save as **Bar**.
3. On the **Solid** menu, click **Box**, and then click **Corner to Corner, Height**.
4. For the **First corner** type **0,0**, and press **Enter**.
5. For the **Length** type **15**, and press **Enter**.
6. For the **Width** type **6**, and press **Enter**.
7. For the **Height** type **1**, and press **Enter**.

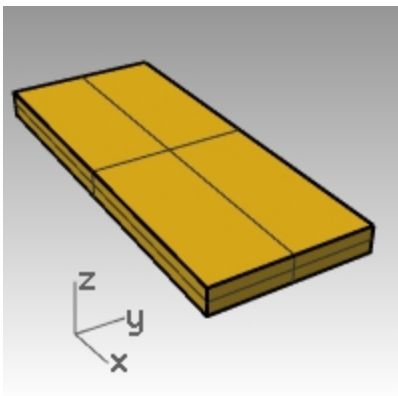

### Edit a surface

---

1. On the **Solid** menu, click **Extract Surface**.
2. For the **Surface to extract**, select the top and both end surfaces, press **Enter**.
3. Select the two ends and delete them.

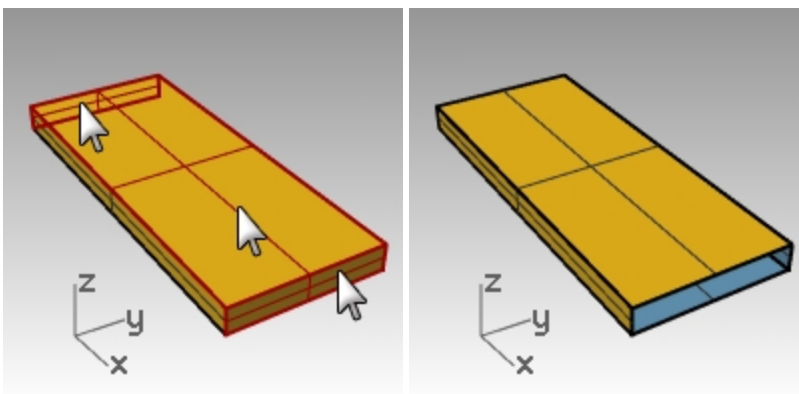

4. Select the top surface.
5. On the **Edit** menu, click **Rebuild**.

- In the **Rebuild Surface** dialog box, set the **Point count** to **4** and the **Degree** to **3** for both **U** and **V**, click **OK**.

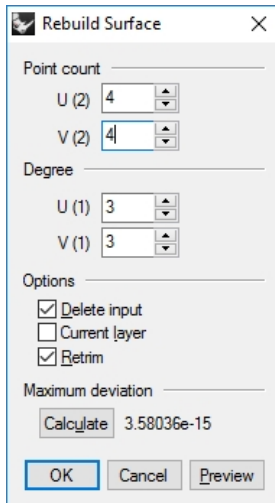

- Turn control points on.
- In the **Right** viewport, window select the middle points.
- Drag the points up approximately one unit.
- Turn control points off.

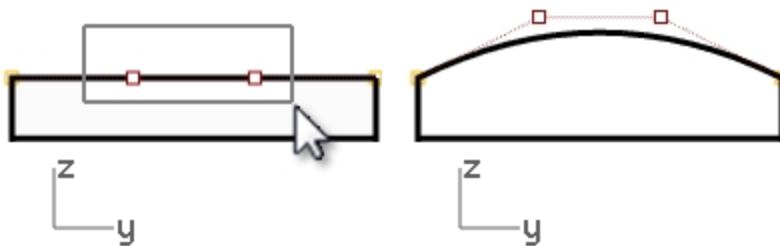

### Make the bar solid

- Select all of the surfaces.
- On the **Edit** menu, click **Join**.  
The surfaces are joined making an open polysurface.
- Select the polysurface.
- On the **Solid** menu, click **Cap Planar Holes**.  
Two end caps are created.

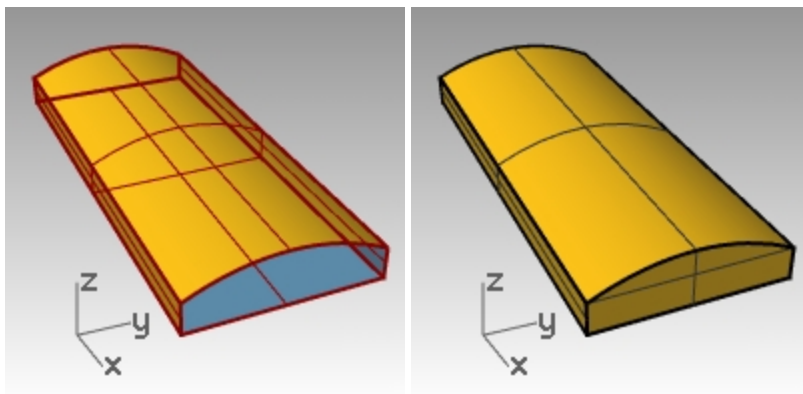

### Fillet the edges

- On the **Solid** menu, click **Fillet Edge**, and then click **Fillet Edge**.
- Set the **Next Radius=1.0**.
- For **Select edges to fillet**, pick the four vertical edges, press **Enter**.

4. For **Select fillet handle to edit**, press **Enter**.

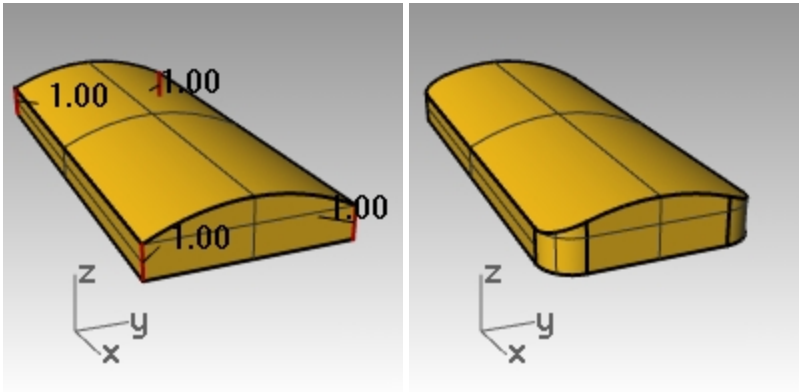

5. Repeat the **Fillet Edge** command.  
 6. Set the **Next Radius=0.2**.  
 7. For **Select edges to fillet**, window select the entire bar to get the horizontal edges, press **Enter**.  
 8. For **Select fillet handle to edit**, press **Enter**.

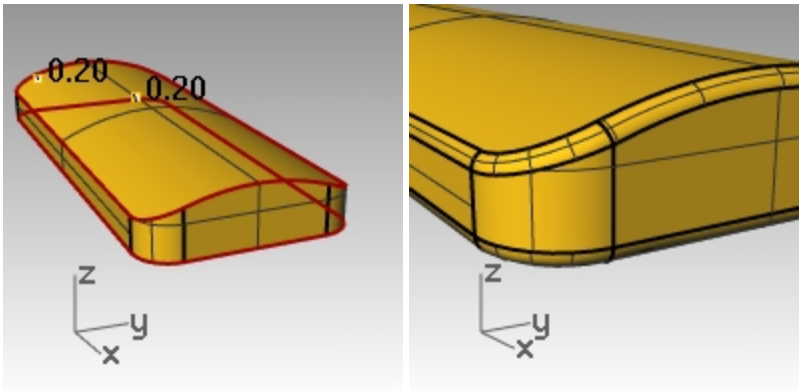

### Make a copy of the bar on a different layer

We need to make a copy of the finished bar for the next part of this exercise. On one of the copies we will engrave text, on the other we will emboss text.

1. Select the finished bar.
2. On the **Edit** menu, click **Layers**, then **Copy objects to layer**.
3. In the **Select layer to copy objects** dialog, pick **Layer 01**, and click **OK**.
4. In the **Layers** panel, turn **Layer 01** off.

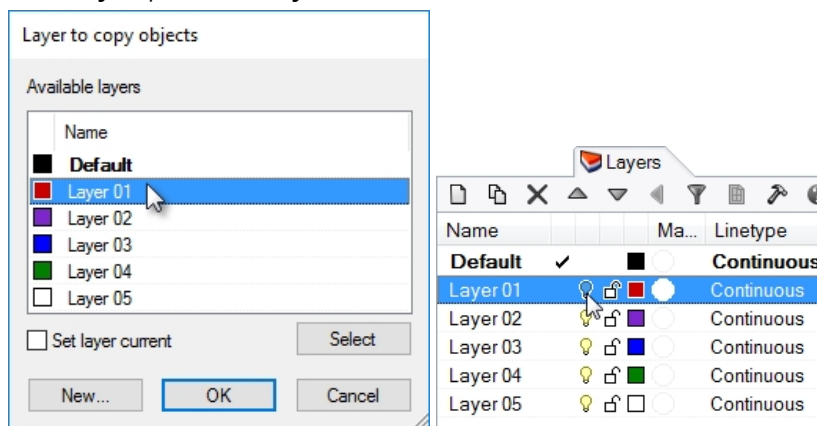

### Make solid text

1. Make **Layer 02** current.
2. On the **Solid** menu, click **Text**.
3. In the **Text Object** dialog box, set the **Height** to **3.00**,

4. In the **Font** list, pick a font like **Arial**.
5. Click the **B** button to set the text format to bold.
6. In the **Output** section, click **Solids** and set the **Thickness** to **1.00**.
7. Check **the Group output**, and click **OK**.
8. For the **Insertion point** in the **Top** viewport, position the text in the center of the bar and click.

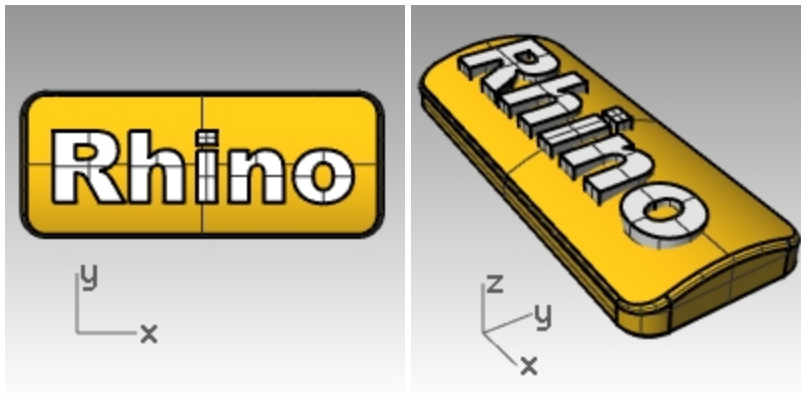
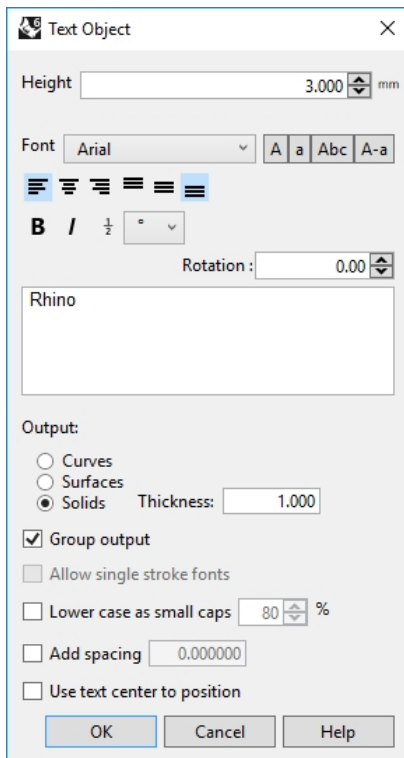

9. In the **Front** or **Right** viewport, drag the text until it protrudes through the top surface.

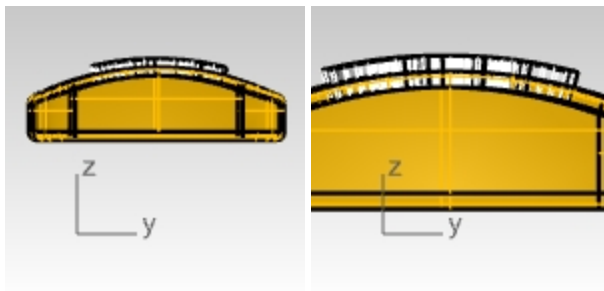



### Engrave the text in the bar

1. Select the bar.
2. On the **Solid** menu, click **Difference**.
3. For **Select second set**, set **DeleteInput=Yes**, select the text, press **Enter**.

The text is engraved into the bar. However, it does not follow the curvature of the bar. Let's look at how to make this text better follow a curved surface.



### Offset solid text

Occasionally you will want to create text that exactly follows the curvature of a base surface. One method is to split the top surface of the bar with the text curves and offset the surface into solid text objects. The solid text can be used to engrave (difference) or emboss (union) into the original surface or polysurface:

### Make a label

1. Turn **Layer 01** on and turn the **Default** layer off.
2. On the **Solid** menu, click **Extract Surface**.
3. Set **Copy=Yes**.
4. Select the top surface, press **Enter**.

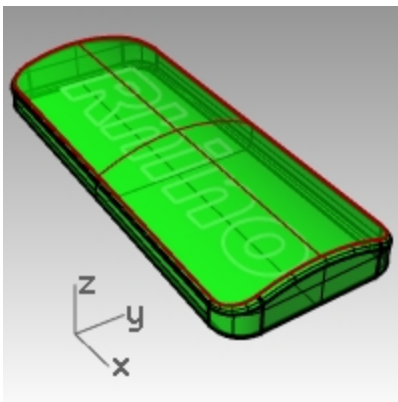

5. **Hide** the lower part of the bar.  
The top surface will only remain visible.
6. In the **Top** viewport, on the **Solid** menu, click **Text**.

- In the **Text Object** dialog box, under **Output**, click **Curves**, check **Group output** and set the **Height** to **3**, if it not already. Click **OK**.

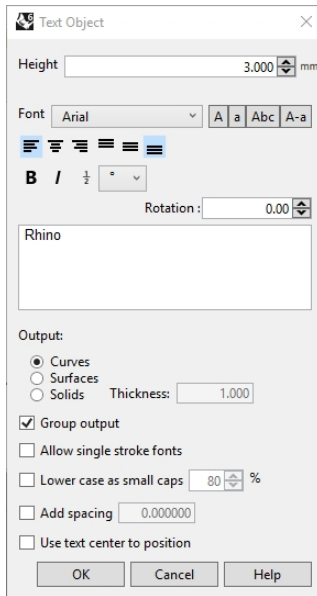

- For the **Insertion point**, position the text in the center of the bar in the **Top** viewport and click.  
**Hint:** Use Gumball to scale the text curves for acceptable size and placement.

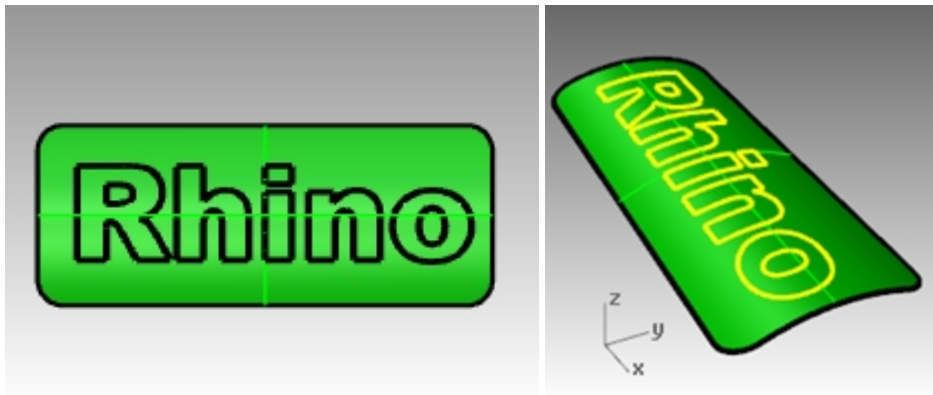

### Trim the top surface of the bar with the text

- In the **Top** viewport, select the text curves.  
Since the Group objects box was checked when you created the text, you can pick all of the text by clicking on one element.



- On the **Edit** menu, click **Trim**.

3. Select the surface in three places: near outer edge, in center of O, and in center of R.  
Remember to trim out the center of letters like R and O.

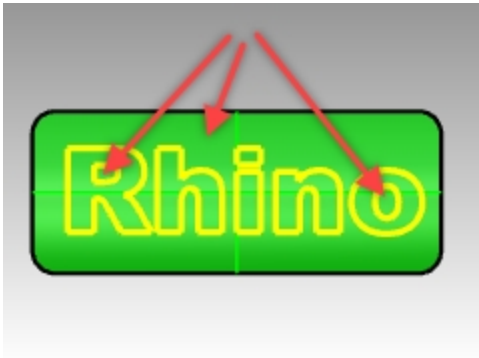

The curves have split the surface. The outside surface has been deleted and each part of the text is a separate surface.



4. **Delete** the original text curves.  
**Hint:** The **SelCrv** command will select just the curves.
5. Select the text surfaces.  
**Hint:** The **SelSrf** command will select just the surfaces.
6. On the **Edit** menu, click **Group**, and then click **Group**.  
The text surfaces are now grouped for easier selection.



### Create solid text

1. On the **Edit** menu, click **Select Objects**, and then click **Previous Selection**.  
This selects the text surfaces again. Or since they are grouped, you can pick on any one of the surfaces, and they will all select.
2. On the **Surface** menu, click **Offset Surface**.
3. For the **Offset distance**, click **Bothsides=Yes**, **Solid =Yes**, and **DeleteInput=Yes** in the Command line.  
**Bothsides** will create the offset located on both sides of the original.

- For the **Distance**, type **.1**, and press **Enter**.

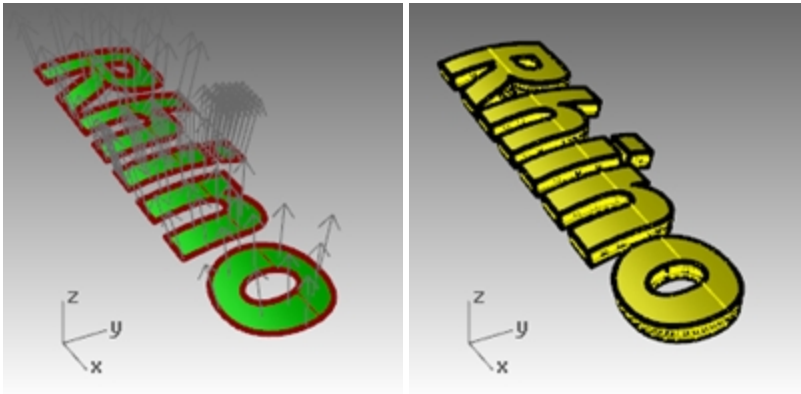

**Hint:** Keep the letters separate to render a different material than the bar.

- Show** the bottom part of the bar. (You used the **Hide** command on it in an earlier step.)
- Use the gumball to **Copy** the bar and solid text to create a second additional set.

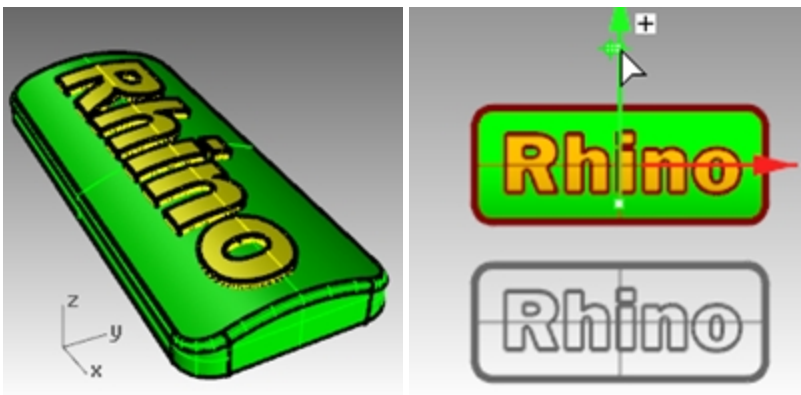

### Modeling embossed text

Next you will union the solid text with the bottom solid bar.

- Select the first set of bar and solid text.
- On the **Solid** menu, click **Union**.
- The text and the bar are unioned into one closed polysurface with the text embossed on the top bar surface.



### Modeling engraved text

Next you will difference the solid text from the bottom solid bar.

- Select the bottom polysurface of the second set.
- On the **Solid** menu, click **Difference**.

- For the **Select surfaces or polysurfaces to subtract** with **DeleteInput=Yes**, select the second solid text, and press **Enter**.  
The second set of the solid text and the bar are joined into one closed polysurface with the text engraved into the bar surface.

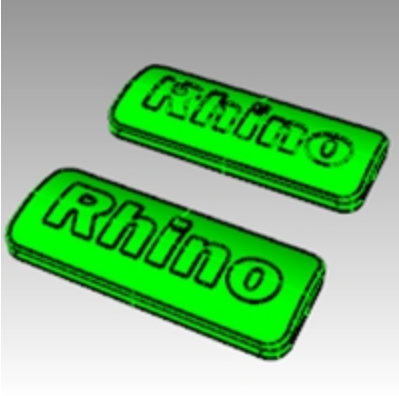

- On the **Render** menu, click **Render**.



*Embossed polysurface.*



*Engraved polysurface.*



# Chapter 11 - Creating surfaces

---

A Rhino surface is similar to a piece of stretchy fabric. It can take on many different shapes.

Surfaces are bounded by curves called edges. To visualize the surface shape Rhino displays a grid of isoparametric curves (isocurves) on the surface.

Surfaces have an area, their shape can be changed by moving control points, and they can be meshed.

## Simple Planar Surfaces

Planar or flat surfaces are created by picking points or by picking an existing, closed planar curve. In the next exercise, you will create planar surfaces using these commands.

### Exercise 11-1 Closed polysurface box

---

In this exercise, you will model some simple surfaces.

1. Start a new model, use the **Small Objects - Millimeters.3dm** template.
2. Save as **Surfaces**.
3. Turn on **Grid Snap** and Planar.

#### Create a plane from two corner points

---

1. On the **Surface** menu, click **Plane**, and then click **Corner to Corner**.
2. For the **First corner of plane**, pick a point.
3. For the **Other corner**, pick another point to make a rectangular plane.

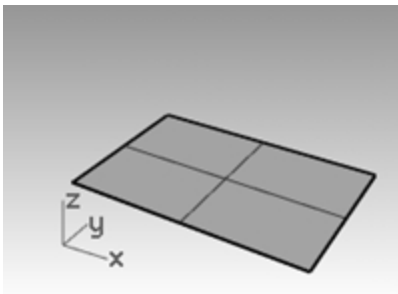

#### Create a vertical plane

---

1. On the **Surface** menu, click **Plane**, and then click **Vertical**.
2. For the **Start of edge**, snap to the endpoint at the right side of the surface.
3. For the **End of edge**, snap to the other endpoint at the right side of the surface.
4. Drag your cursor up and pick.

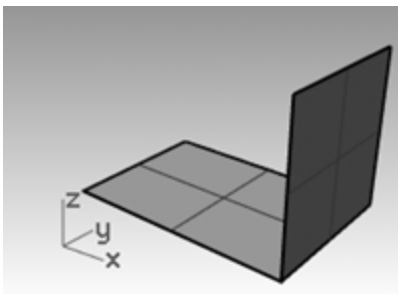

#### Create a plane from three points

---

1. On the **Surface** menu, click **Plane**, and then click **3 Points**.
2. For the **Start of edge**, snap to the endpoint at the left of the first surface.
3. For the **End of edge**, snap to the other endpoint at the left side of the first surface.

4. For the **Height**, use **SmartTrack** to track a point from the top of the vertical plane.

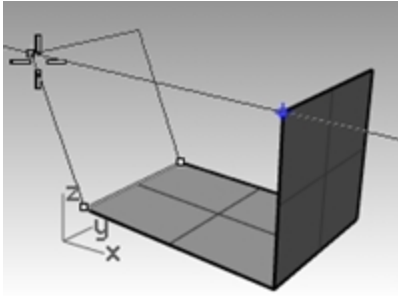

Drag the tracking point until the surface is tilted slightly and click.

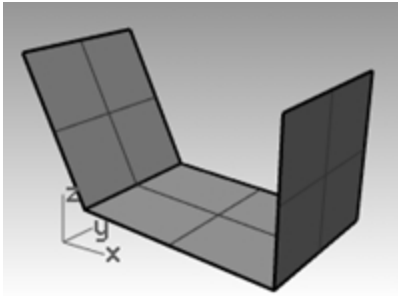

### Create a plane from corner points

1. On the **Surface** menu, click **Corner Points**.  
When you pick the points in the next four steps, pick them in a clockwise direction.
2. For the **First corner**, snap to an endpoint at the edge of the first surface.
3. For the **Second corner**, snap to the endpoint at the edge of the second surface.
4. For the **Third corner**, snap to an endpoint at the edge of the third surface.
5. For the **Fourth corner**, snap to the other endpoint at the edge of the third surface.

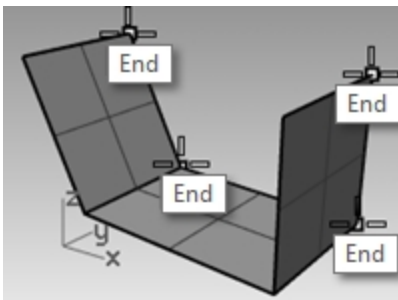

A surface will be created with corners at the points you selected.

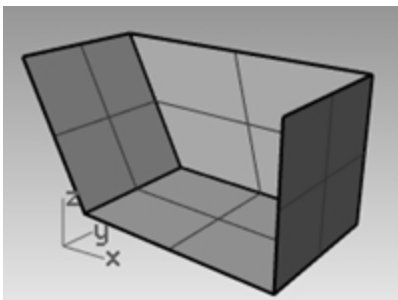



### Create a surface from planar curves

1. Turn **Planar** mode on.
2. Draw a curve that starts and ends at the top of the two vertical surfaces as shown below.  
**Planar** mode keeps this curve on the same plane as the surface corners.

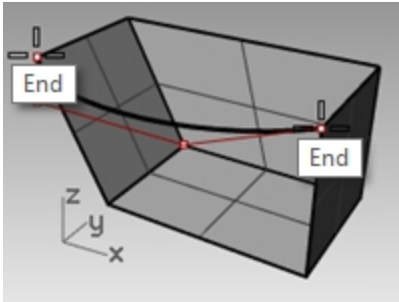

1. On the **Surface** menu, click **Planar Curves**.
2. Select the curve you just created.
3. Select the top edge of the three surfaces and press **Enter**.

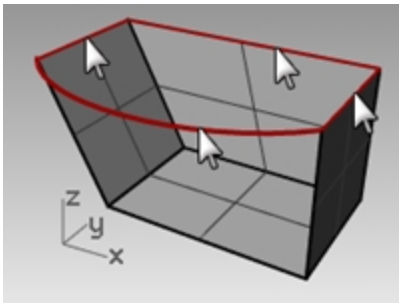

A surface is created.

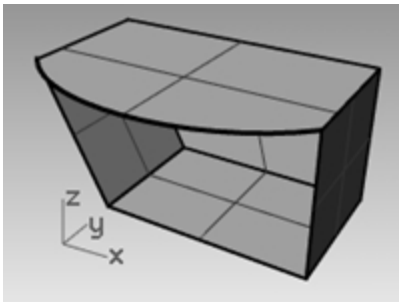

### Create a surface from edge curves

1. On the **Surface** menu, click **Edge Curves**.
2. Select the four surface edges.

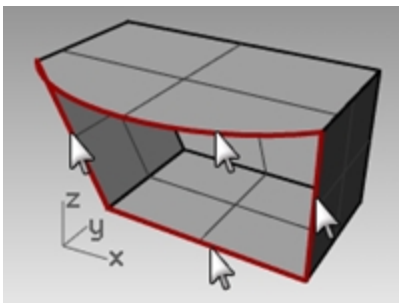

A surface is created.

3. Select all the surfaces, and on the **Edit** menu, click **Join**.

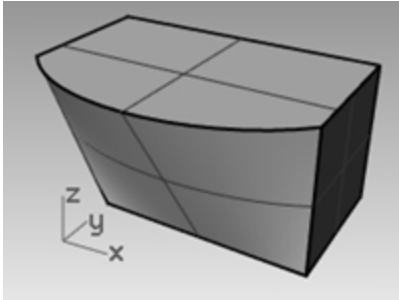

Result should be valid, closed polysurface.

**Hint :** Use the **What** command to confirm that offset polysurface is valid, closed solid.

## Surfaces from Extruded curves

The extrude curve commands create surfaces by tracing the path of a curve in a straight line or to follow a specific curve. You can also extrude to a point or tapered.



## Exercise 11-2 - Retro handset

In this exercise, you create a 1990's style cordless phone using extrusions. This technique can be used to create other hand-held controls. To aid in organizing the model, surface and curve layers have been created. Make sure you change layers as you are making the surfaces.

### Extrude curves to surface the phone

1. Open the model **Extrude.3dm**.
2. Make the **Top Surface** layer current.
3. Select the curve as shown.

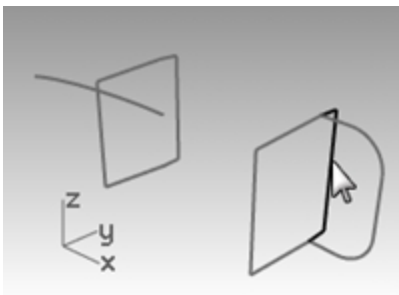

4. On the **Surface** menu, click **Extrude Curve**, and then click **Straight**.

5. Drag the cursor in the -x direction or towards the second vertical rectangle. This will tell Rhino the direction of the extrusion.

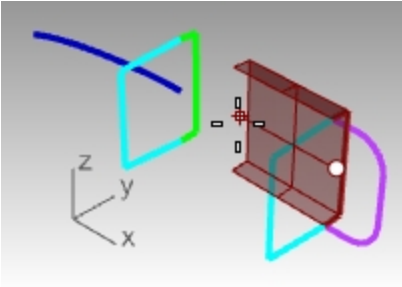

6. At the **Extrusion distance** prompt, type **3.5** and press **Enter**.  
**Note:** If the object being extruded is a planar curve, the curve is extruded perpendicular to the plane of the curve.

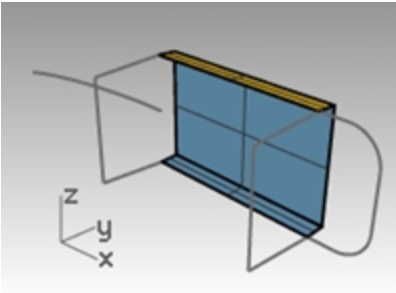

### Extrude a curve along another curve

1. Select the curve (1) on the left of the first extruded surface.

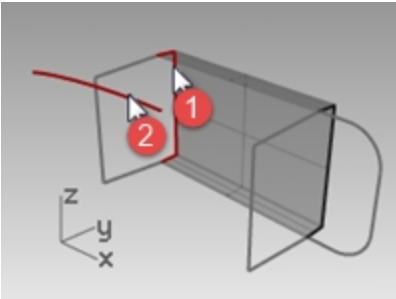

2. On the **Surface** menu, click **Extrude Curve**, and then click **Along Curve**.
3. Select the **path curve** (2) near its right end.  
The curve is extruded along the path of the secondary curve.  
If you don't get the answer you expected, undo and try picking near the other end of the path curve.

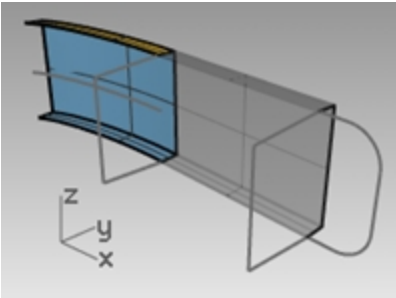

### Extrude a curve with a taper (draft angle)

---

1. Select the curve on the right.

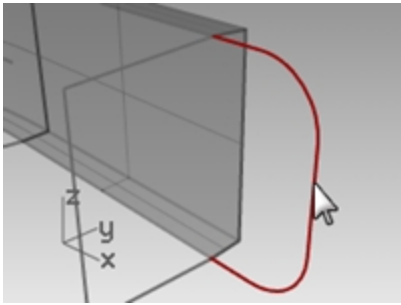

2. On the **Surface** menu, click **Extrude Curve**, and then click **Tapered**.
  3. For the **Extrusion distance**, click **DraftAngle** in the Command line.
  4. For the **Draft angle**, type **-3** and press **Enter**.
  5. For the **Extrusion distance**, type **.375** and press **Enter**.
- The curve is extruded with a three-degree draft angle in the positive direction on the y-axis.

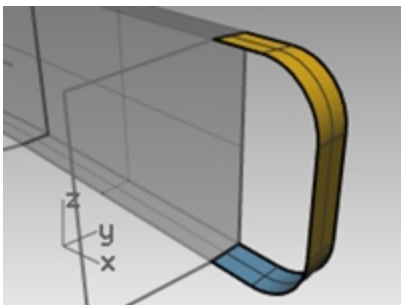

### Create a surface from planar curves

---

1. On the **Surface** menu, click **Planar Curves**.
2. Select the edge curves that bound the opening of the tapered extrusion at the top.

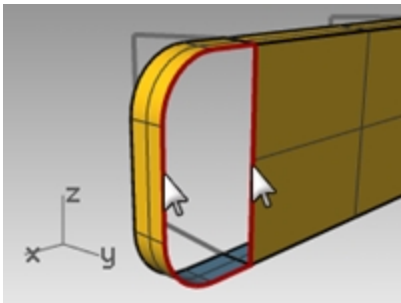

3. Press **Enter**.
- A surface is created at the end.

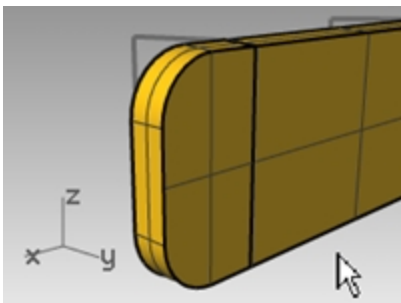

4. Select the four surfaces.

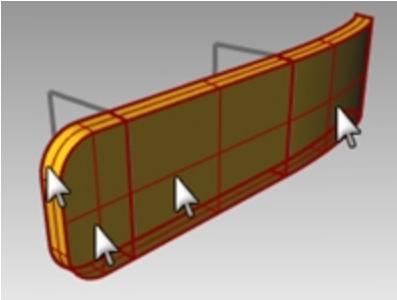

5. On the **Edit** menu, click **Join**.

### Make the extruded surfaces for the other half of the phone

Next, we will repeat the previous steps for the other half of the phone.

1. Make the **Bottom Surface** layer current.
2. Select the curve as shown.

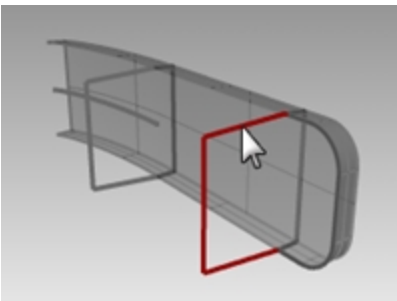

3. On the **Surface** menu, click **Extrude Curve**, and then click **Straight**.  
Drag the cursor in the -x direction or towards the second vertical rectangle. This will tell Rhino the direction of the extrusion.
4. For the **Extrusion distance**, type **-3.5** and press **Enter**.  
If the object being extruded is a planar curve, the curve is extruded perpendicular to the plane of the curve.

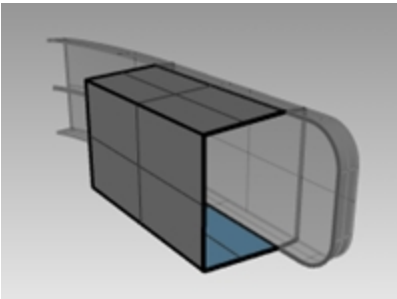

5. Select the curve (1) on the left of the first extruded surface.

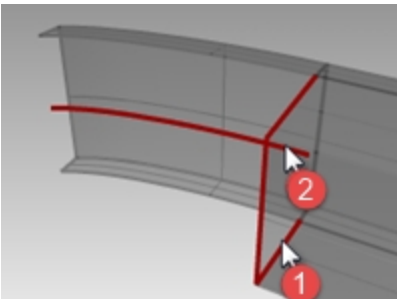

6. On the **Surface** menu, click **Extrude Curve**, and then click **Along Curve**.

7. Select the path curve (2) near its right end.  
The curve is extruded along the path of the secondary curve.

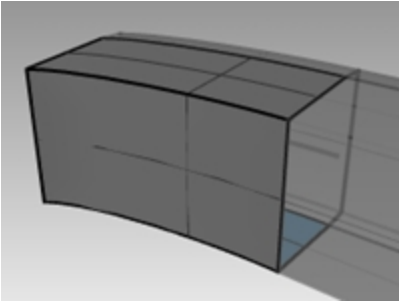

8. Select the curve on the right.

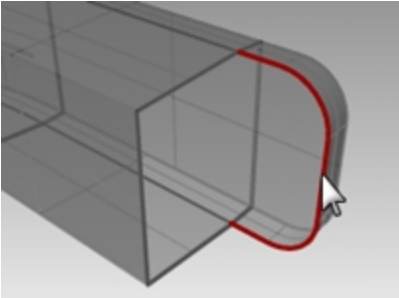

9. On the **Surface** menu, click **Extrude Curve**, and then click **Tapered**.
10. For the **Extrusion distance**, type **-1.375** and press **Enter**.  
The curve is extruded with a three-degree draft angle in the negative direction on the y-axis.

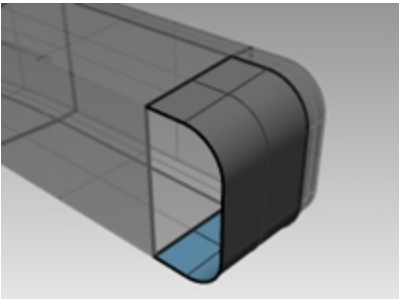

11. On the **Surface** menu, click **Planar Curves**.
12. Select the edge curves that bound the openings of the tapered extrusion at the top.

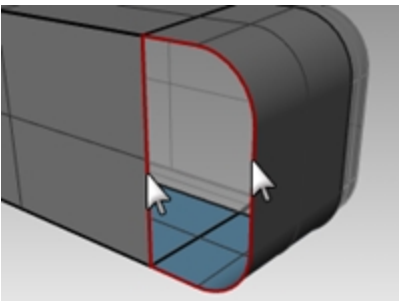

13. Press **Enter**.

A surface is created at the end.

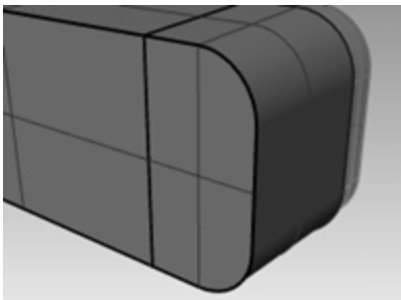

### Join the surfaces

1. Select the four surfaces.
2. On the **Edit** menu, click **Join**.

### Create an extruded surface on both sides of a curve

1. Turn on the **Extrude Straight-bothsides** layer.
2. Select the free-form curve as shown.

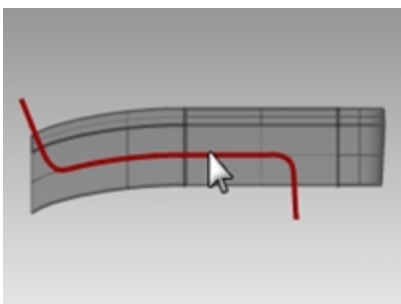

3. On the **Surface** menu, click **Extrude Curve**, and then click **Straight**.
4. For the **Extrusion distance**, click **Bothsides** in the Command line.

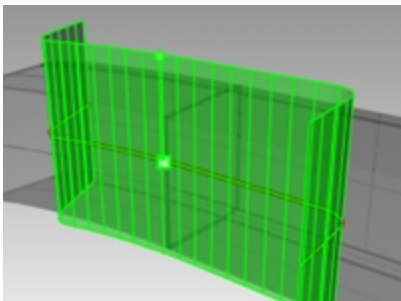

5. For the **Extrusion distance**, drag the extrusion and pick.  
Make sure the surface extends past the other surfaces in both directions. The surface is extruded symmetrically from the curve.

## Basic techniques joining surfaces together

### Trim the surfaces

1. Select the joined top and bottom polysurfaces, and the surface you just extruded.

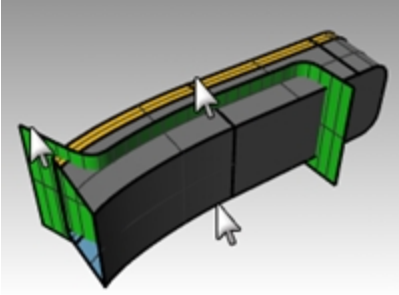

2. On the **Edit** menu, click **Trim**.
3. For the **Object to trim**, pick the outer edge of each surface.

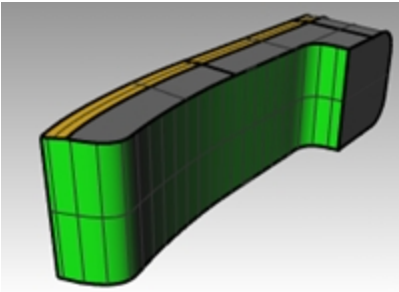

### Split the trimmed surface

1. Select the trimmed extruded surface.
2. On the **Edit** menu, click **Split**.
3. For **Select cutting objects**, in the Command line, click **Isocurve**.  
Drag your cursor along the surface to determine which isocurve direction is selected.

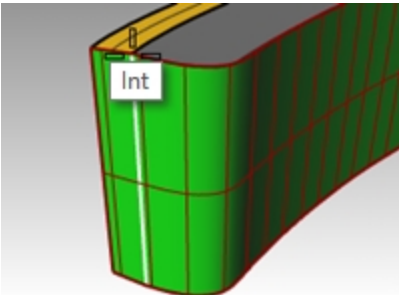

4. Click **Toggle** in the Command line if it is not the correct direction.
5. For the **Split point**, snap to the intersection where all three surfaces intersect.
6. Press **Enter**. The surface is split into two surfaces along that isocurve.

### Join

Next you will join the split surface and the polysurface for the top and the bottom of the handset. The left (smaller) part of the split surface goes with the top of the phone handset, the larger part goes with the bottom part of the phone handset.



### Join the surfaces

1. Select the left (smaller) part of the split surface and the top polysurface.

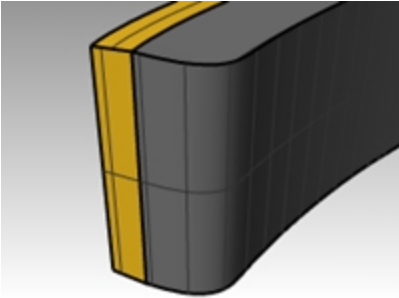

2. On the **Edit** menu, click **Join**.
3. Select the larger part of the split surface and the bottom polysurface
4. On the **Edit** menu, click **Join**.

### Round the edges of the polysurfaces

1. On the **Solid** menu, **Fillet Edge**, then **Fillet Edge**.  
Use a radius of **.2** to round the edges.
2. For the **Select edges to fillet**, select the edges around the top of the top polysurface and the two horizontal edges at the front, press **Enter**.

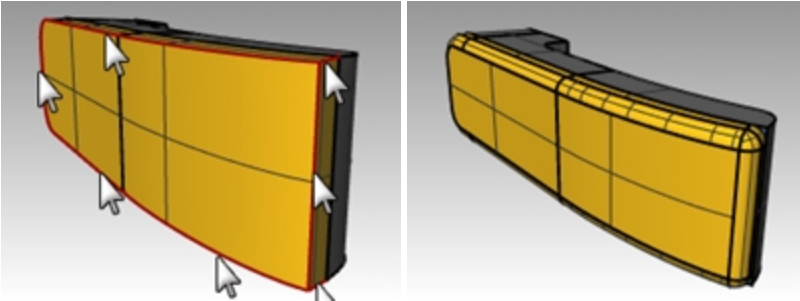

3. For the **Select fillet handle to edit**, click the command-line option to set **Preview=Yes**.
4. Check the model to make sure the fillet is doing what you expect, press **Enter**.
5. Repeat these steps for the Bottom polysurface.

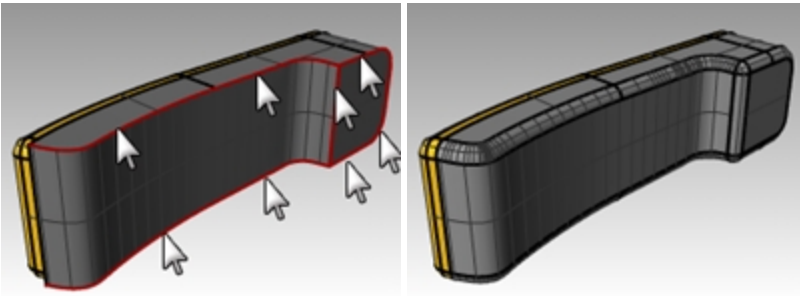

### Create an extruded surface from a curve to a point

1. Turn on the **Extrude to a Point** layer.
2. Turn off the **Extrude Straight** and **Extrude Along Curve** layers.
3. Select the U-shaped curve on the **Extrude to a Point** layer.
4. On the **Surface** menu, click **Extrude Curve**, and then click **To Point**.

- For the **Point to extrude to**, snap to the point object near the top surface. The curve is extruded to the point.

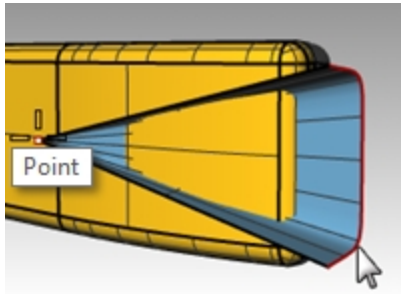

- On the **Solid** menu, click **Difference** command to remove the surface from the top of the phone. If the result is not correct, flip the normals of the top polysurface or the extruded surface with the **Dir** command. The normals of the top polysurface and the extruded surface should point toward each other.

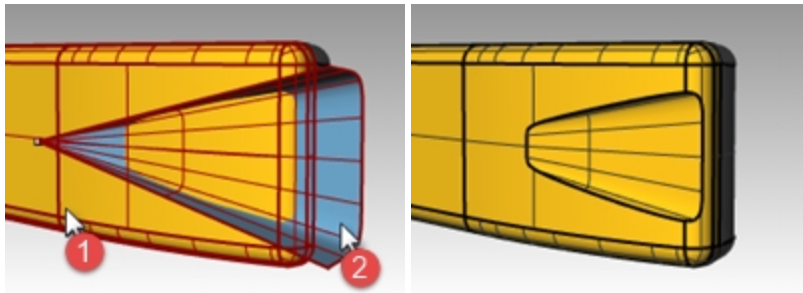

- Select the circle.
- On the **Surface** menu, click **Extrude Curve**, and then click **To Point**.
- For the **Point to extrude to**, snap to the point object inside the bottom surface. The curve is extruded to the point.

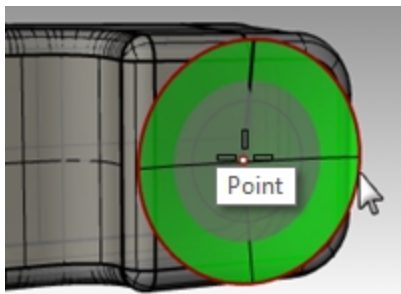

- To remove the surface from the top of the phone, on the **Solid** menu, click **Difference**.

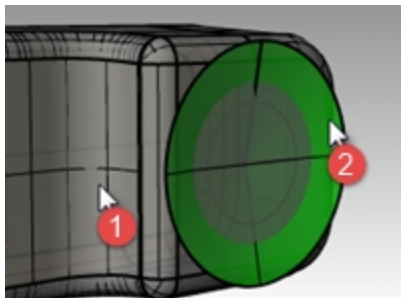

The normals of the bottom polysurface and the extruded surface should point toward each other.

11. **Save** your model as **Phone**.

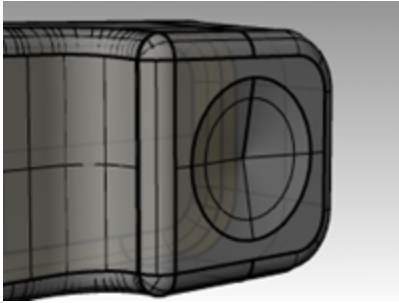

### Create the buttons

1. Turn on the **Curves** for **Buttons** layer.
2. In the **Front** viewport, window select the first column of buttons. Three curves are selected.
3. On the **Solid** menu, click **Extrude Planar Curve**, and then click **Straight**.
4. On the Command line, click, **Solid=Yes** and **Bothside=Yes**.
5. For the **Extrusion Distance**, type **.2** and press **Enter**.

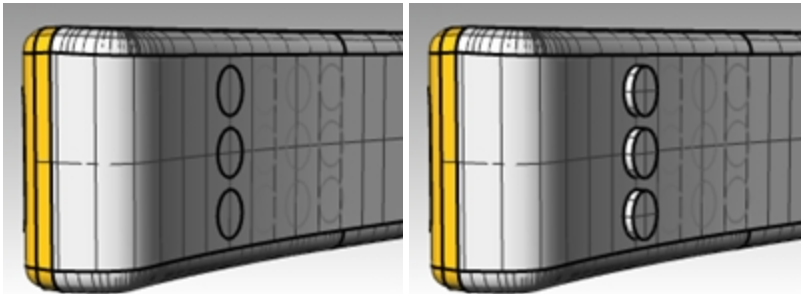

6. Repeat these steps for the other columns of buttons.

### Round the button edges

1. On the **Solid** menu, click the **Fillet Edge**, and then click **Fillet Edge** with a radius of **.05** to round the edges. The button edges are rounded.

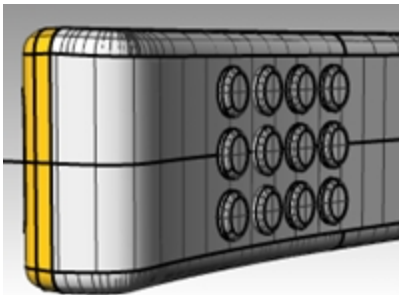

2. **Save** your model.

## Lofted surfaces

The **Loft** command fits a surface through selected profile curves that define the surface shape.

Select the curves in the order in which the surface should pass through them. Select open curves near the same ends.

You can not mix open and closed curves in the same **Loft** command.

### Exercise 11-3 Loft surfaces— The Canoe

Create the side surfaces of the canoe with the **Loft** command. **Offset** the surface, **Trim** and **Join**. The seats are created to fit to inside the canoe and the bumper on the outer edge of the canoe. **Contour** and **Section** the sides of the canoe. Apply materials and render.

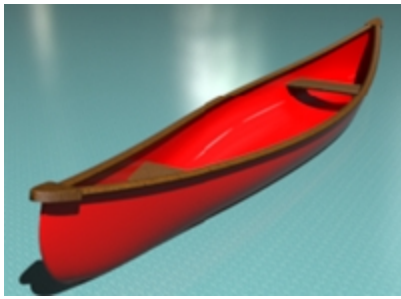

### Loft the Side

---

1. Open the model **Loft.3dm**.
2. Window select all of the curves.

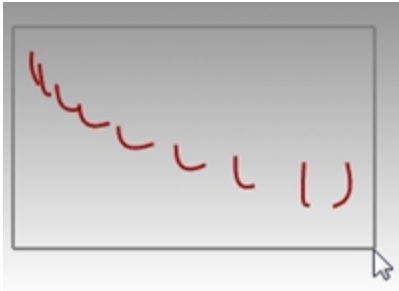

3. On the **Surface** menu, click **Loft**.  
A surface is fitted over the curves.

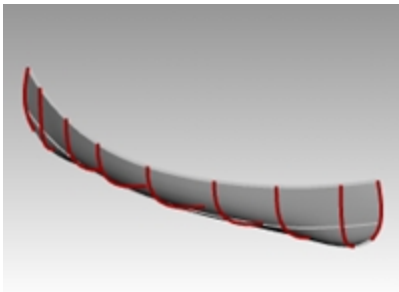

4. In the **Loft Options** dialog box, set the **Style** to **Straight sections**.  
A surface is fitted through the curves, but the sections are straight between the curves.

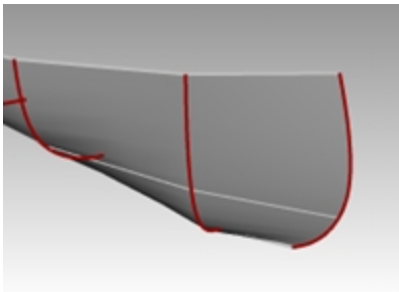

5. In the **Loft Options** dialog box, set the **Style** to **Loose**.  
A surface is created that uses the same control points as the curves. The surface follows the curves more loosely. Use this option when you want the surface to conform to the control points of the input curves.

6. In the **Loft Options** dialog box, switch **Style** to **Normal**, and then click .

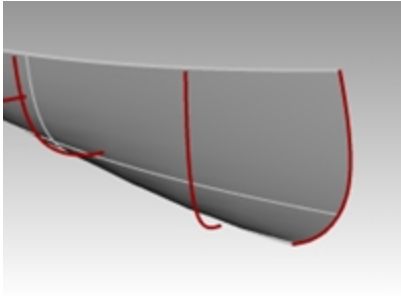

7. Highlight the surface.  
8. On the **Surface** menu, click **Offset Surface** and set **Distance=.1**, **FlipAll** and **Solid=no**.  
The offset inside surface is created.

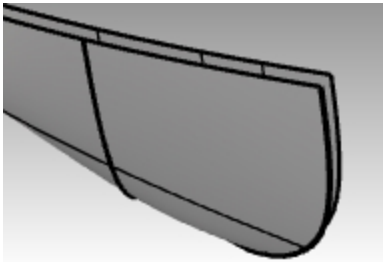

9. Highlight the outside polysurface.  
10. From **Edit** menu, click **Visibility** and **Hide**.  
You will make the surface visible again with **Show** off the same menu, after the seats have been created.

### Trim inside surface to line curve

Trim to a line curve then erase the curve.

1. On the **Curve** menu, pick **Line** and **Single line**.
2. In the Command line, pick the **BothSides** options.
3. Locate the middle of the line at the origin by typing **0** and .
4. For the second point, with **Ortho** on, pick a second point to the right or left.

**Hint:**  to toggle the **Ortho** state.

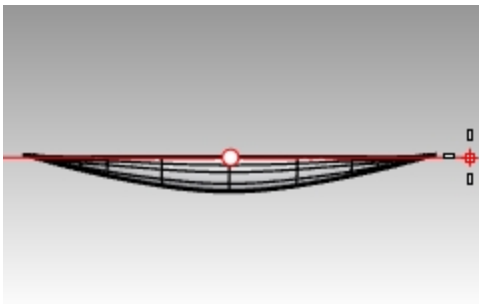

5. Select the curve. Now you will **Trim** using the line.
6. On the **Edit** menu, click **Trim**. The highlight curve will be used as the cutting object.
7. In the **Top** view, pick the surfaces to trim as instructed in the section above.
8. Erase the line curve used as the cutting object.
9. Mirror and join as instructed in the section above.

### Alternative: Trim inside surface with IP

Undo the previous trim, if you would like to try the trim to an invisible infinite plane. With this option, there will be no trimming object to erase.

1. Select the inside surface. Now you will **Trim** using the option **IP** or **Infinite Plane**.
2. On the **Edit** menu, click **Trim** and type **IP** for **Infinite Plane** and .
3. Next in **Top** viewport, pick **Vertical** option and type **0**.

- At the **End of Vertical Plane** prompt, with **Ortho** on, pick anywhere along the **X Axis**. Press **Enter**.  
**Hint:** **Shift** to toggle the **Ortho** state.

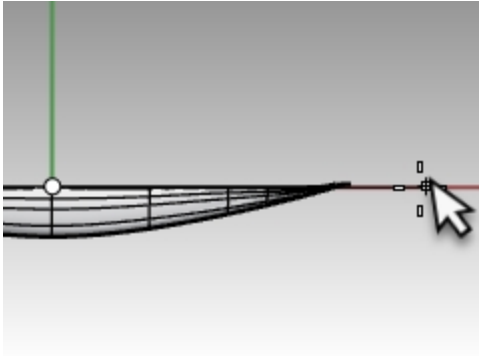

- In the **Top** view, pick the surfaces to trim.  
 There are two surface that extend beyond the Infinite Plane in the **Top** view on each end of the canoe. Trim on the right, then pan to trim the surfaces on the left of the canoe.  
 When done, **Enter** again to exit the **Trim** command.

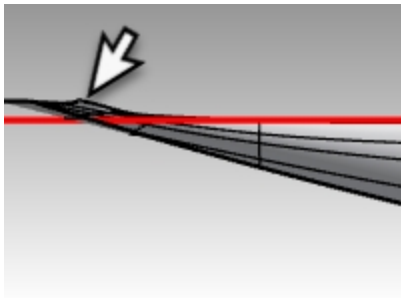

*Left Side of Canoe*

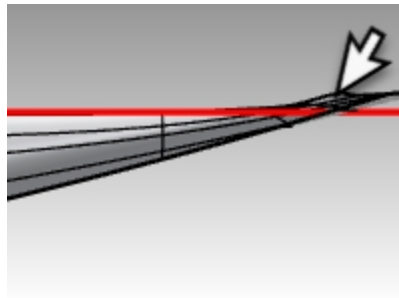

*Right Side of Canoe*

The surface will be trimmed back to the infinite plane.

- Mirror** the surface to create the other half.  
**Hint:** you may also use the origin 0 and any pick along the x axis.

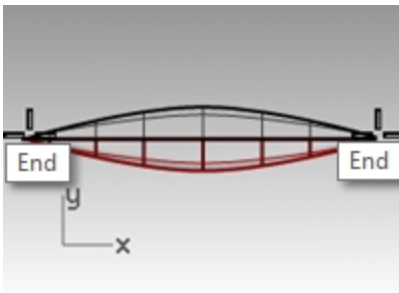

- Join** the two halves.

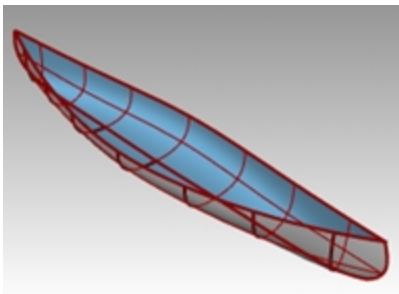

- Select the hull polysurface.

- In the **Properties** panel, verify that you have one polysurface.

### Make a seat

- Turn the **Hull Curves** layer off and turn the **Seat Curves**, and **Seats** layers on.
- Make the **Seat Curves** layer current.
- In the **Front** viewport, select the rounded rectangles.

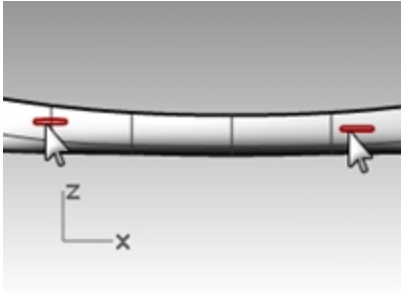

- On the **Curve** menu, click **Curve From Objects**, and then click **Project**.

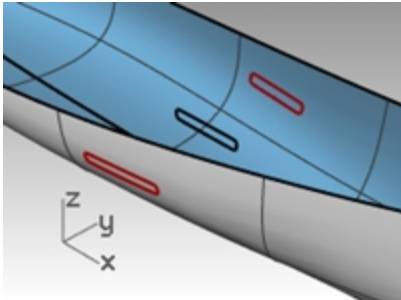

Project uses the current construction plane to determine the direction of projection. Make sure you select the curves and surface to project onto in the **Front** viewport.

- For the **Surface to project onto**, select the hull.  
The curves will be projected to both sides of the hull surface.
  - Select one pair of curves on the surface.
  - Make the **Seats** layer current.
  - From the **Surface** menu, click **Loft**.
  - In the **Loft Options** dialog, click **OK**.
  - Repeat this for the other seat.
- A surface is fitted over the curves that fit exactly with the shape of the hull.

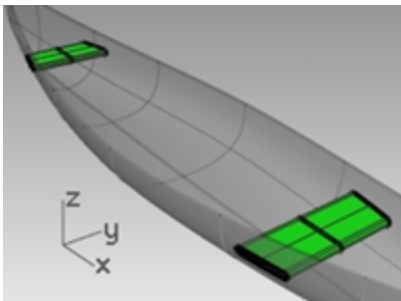

- On the **Layers** panel, turn the **Seat Curves** and **Seat** layers off

### Create section curves from the surfaces

- Select the hull.
- Make the **Sections** layer current.
- From the **Curve** menu, click **Curve From Objects**, and then click **Section**.

- For the **Start of section**, in the **Top** viewport, pick a point to the left at the center of the hull.

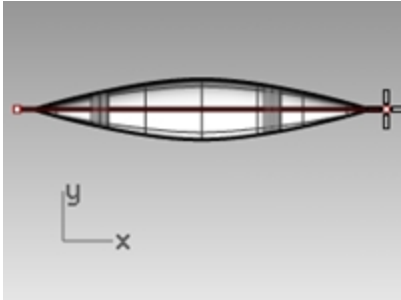

- For the **End of section**, with **Ortho** on, drag a line to the right and pick. A curve is generated on the surface. Repeat this at various locations.

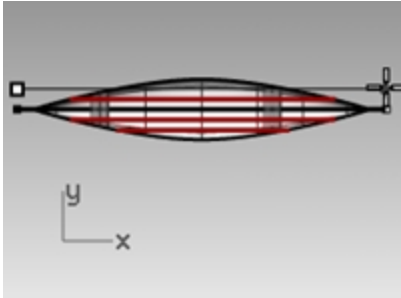

- Press **Esc** to deselect the section curves.

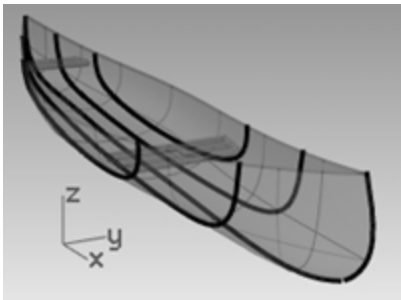

### Create contour curves across the hull surfaces

- Select the hull.
- Make the **Contours** layer current.
- From the **Curve** menu, click **Curve From Objects**, and then click **Contour**.
- For the **Contour base point**, snap to the left end of the canoe.

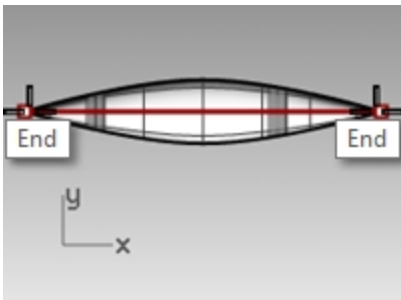

- For the **Direction perpendicular to contour planes**, snap to the other end of the canoe.



- For the **Distance between contours**, type **12**, and press **Enter**.  
A curve is generated every foot along the hull.

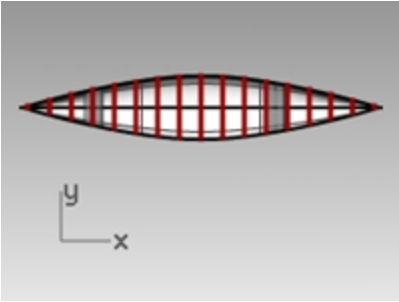

- Press **Esc** to deselect the contour curves.

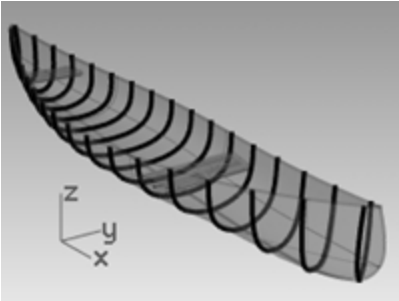

- In the **Layers** panel, turn off the **Contours** layer.

### Mirror the outside hull surface

- From **Edit** menu, pick **Visibility** and **Show**  
You will see the outside hull surfaces again.
- Highlight the inside hull surface.
- From **Edit** menu, pick **Visibility** and **Hide**  
You will hide the inside hull surfaces while you mirror the outside hull.
- Highlight a outside hull surface.
- Mirror** the surface to create the other half.  
**Hint:** you may also use the origin 0 and any pick along the x axis.

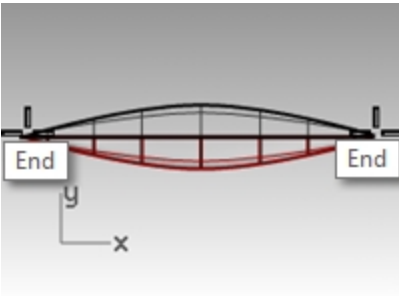

- Join** the two halves.

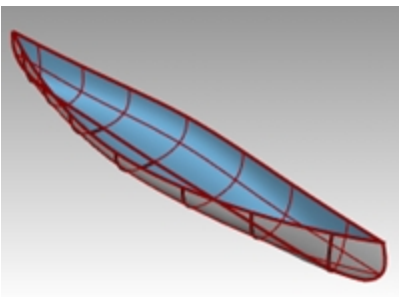

- Select the hull outside polysurface.
- Verify that you have one polysurfaces with **Properties**.

## Make a solid canoe

1. From **Edit** menu, pick **Visibility** and **Show**  
You will see the inside hull surfaces again.
2. From the **Surface** menu, click **Loft**.
3. Pick the curves from one side of the canoe . Pick  for **Normal**. The top surface is created.

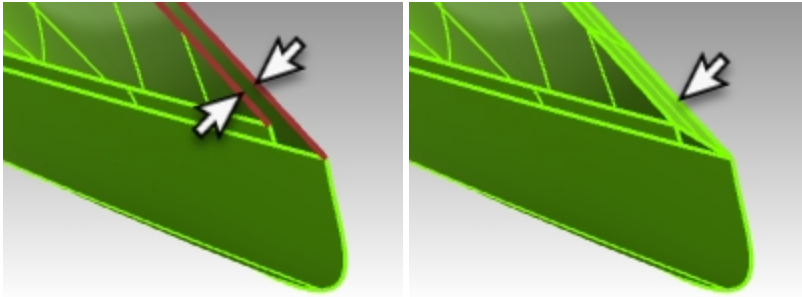

4. Repeat the **Loft** command, and pick the curves on the other side of the canoe. Pick  for **Normal** style. The other top surface is created.

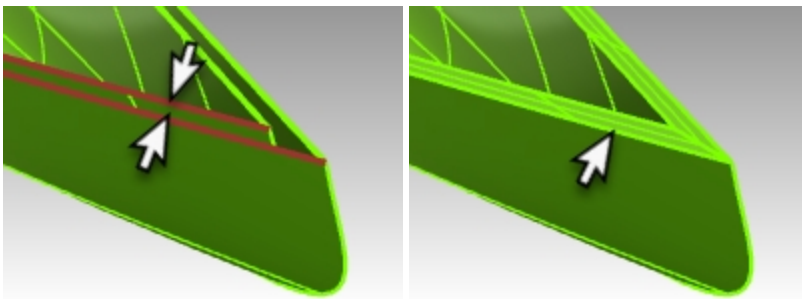

5. Select the two new surfaces and the two hull surfaces,.
6. From the **Edit** menu, pick **Join**  
The hull is joined into one closed polysurface.

**Hint:** If the join is successful, Rhino will echo to the Command line "4 surfaces or polysurfaces joined into one closed polysurface."

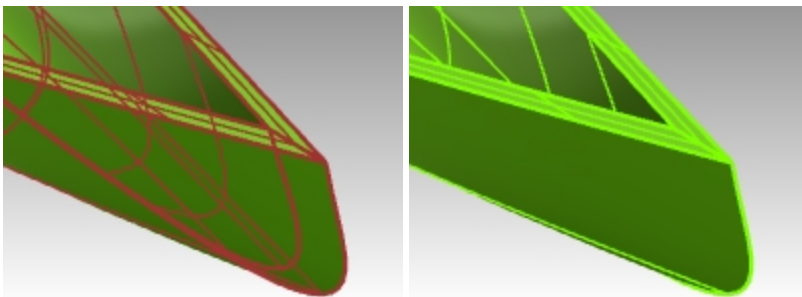

7. Type the **Check** or **What** commands to verify that polysurface is valid and closed.

### Create an edge curve from the surfaces

1. Make the **Top Rail** layer current.
2. From the **Curve** menu, click **Curve From Objects**, and then click **Duplicate Edge**.
3. Select the both top edges of the hull.

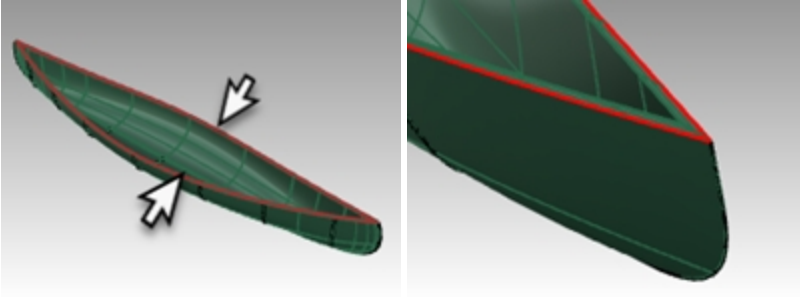

4. Press **Enter**.  
Two curves are generated at the edges of the hull
5. With the curves still selected, on the **Edit** menu, click **Join**.
6. The curve should be closed. Use **Properties** panel to check the curve condition  
**Hint:** if the curve is not closed use the **CloseCrv** command.

### Pipe the rim

1. Select the curve you just joined.

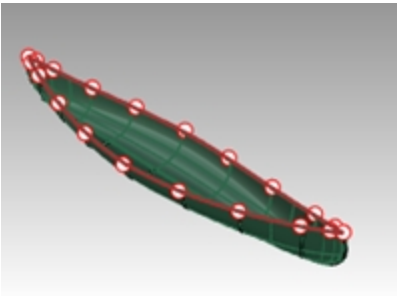

2. From the **Solid** menu, click **Pipe**.
3. Set the radius of closed pipe to 1", press **Enter**.
4. At prompt for the next radius, press **Enter**.  
The pipe solid is created.

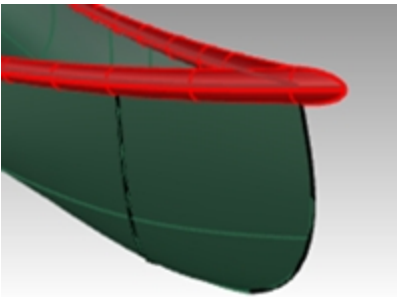

## Render the canoe

You will now Assign materials to the hull and rim layers.

1. In the **Perspectiv** viewport, set the display mode to **Render**.

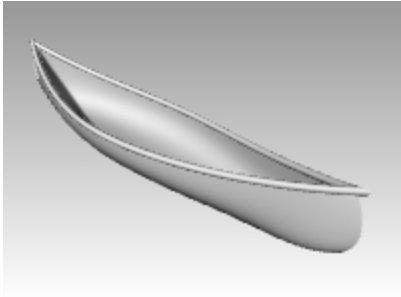

2. In the **Layers** panel, pick on the **Material** icon in the **Hull** layer row.

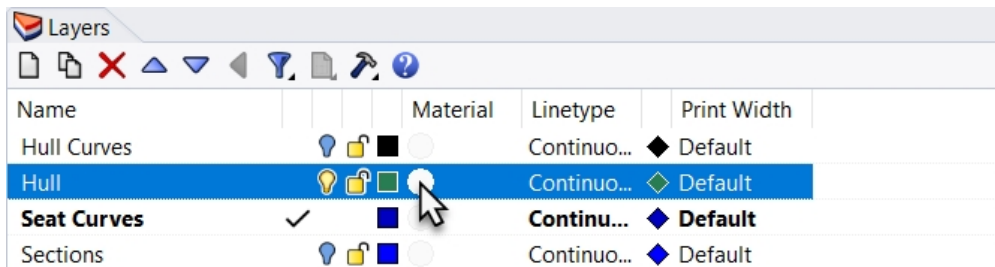

3. In the **Layers Materials** dialog, click and arrow next to Default Material, then click the + next to **Use new material** label. From the menu, click **Plastic** as the new material template. This will create a new material with presets for plastic.

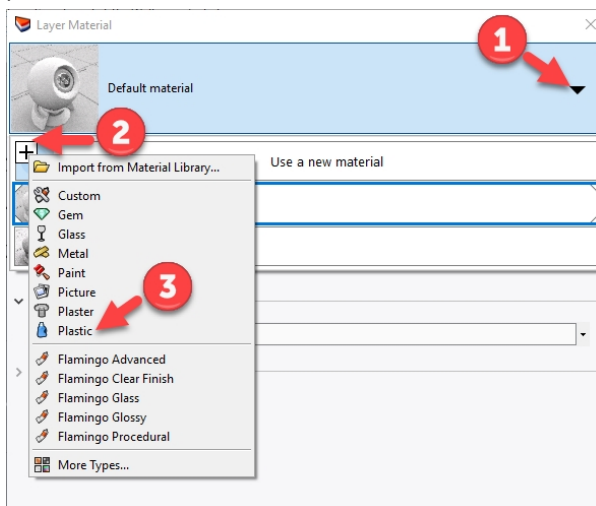

4. In the **Layer Material** dialog, in the **Name** field, type **Yellow\_plastic**.
5. Pick the color swatch, and in the **Select Color** dialog, select a yellow color with the wheel or list. Then click **OK**. The Hull will render preview the yellow plastic material.
6. In the **Layers** panel, pick on the **Materials** icon in the **Top Rail** layer row.
7. In the **Layers Materials** dialog, click and arrow next to Default Material, then click the + next to **Use new material** label. From the menu, click **Plastic** as the new material template. This will create a new material with presets for plastic.
8. In the **Layer Material** dialog, in the **Name** field, type **Green\_plastic**. Then click **OK**.
9. Pick the color swatch, and in the **Select Color** dialog, select a green color with the wheel or list. Click **OK**. Then click **OK** again to close the **Layer Material** dialog. The Top Rail will now preview the green plastic material.

10. **Render** the canoe.

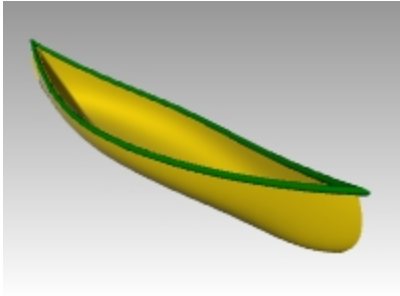

11. Save the render image file to your computer.

### Render with a ground plane

1. From the **Panels** menu, click **Ground Plane**.  
This will open the **Ground Plane** panel
2. From the **Ground Plane** panel, click **On** and Height above setting should be set to **Automatic**.
3. From the Effect section, pick **Use a material**.
4. Click the arrow next to **Default material**, and pick the "+" next to **Use new material**.
5. From the material template menu, select **Custom**.
6. In the **Name** field, type **Water**.
7. In the **Texture** section, under the Color section, click the link "*click to assign texture*".
8. In the **Open** dialog, navigate to your class files folder and select the **Water.jpg**.
9. In the **Custom settings**, area, set the following:  
Gloss 20%  
Reflectivity 10%  
Transparency 10%
10. In **Texture mapping** section (at the bottom of the **Ground Plane** panel), set the X size to 100, and the Y size to 100.  
Pick anywhere on the Rhino viewport. The Render preview should update.
11. If you see an edge of the water texture in your Render preview, move the model to better part of the ground plane.
12. Render and save image file.

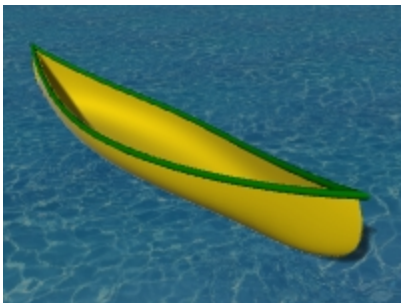

## Revolved surfaces

The **Revolve** command creates a surface by revolving a profile curve that defines the surface shape around an axis. Revolve also supports History.

## Exercise 11-4 Revolve -The Vase

1. Open the model **Revolve.3dm**.
2. Select the free-form curve.



3. On the **Surface** menu, click **Revolve**.
4. For the **Start of revolve axis**, select one end of the curve.

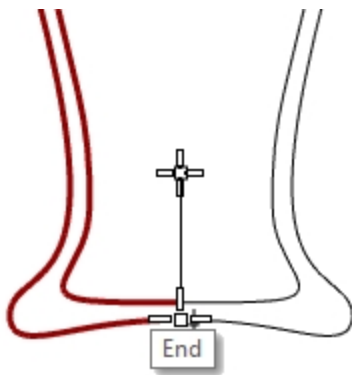

5. For the **End of revolve axis**, select the other end of the curve.
  6. To use the default **Start Angle**, press **Enter**.
  7. To use the default **Revolution Angle**, press **Enter**.
- A surface is revolved around the axis line.



8. From the **Edit** menu, click **Undo**.

### Revolve with History

When History is on, and the **Revolve** command is used, History stores the connection between a command's input and the resulting geometry.

If the input geometry changes, the resulting surface updates accordingly.

However, editing the resulting surface will break the history and the input will no longer drive the output.

For example, with History recording and Update turned on, a revolved surface can be changed by editing the input curves.

Let's redo the revolve with History on.

1. Select the free-form curve.



2. Turn **Record History** on the **Status Bar**
3. On the **Surface** menu, click **Revolve**.
4. For the **Start of revolve axis**, select one end of the curve.

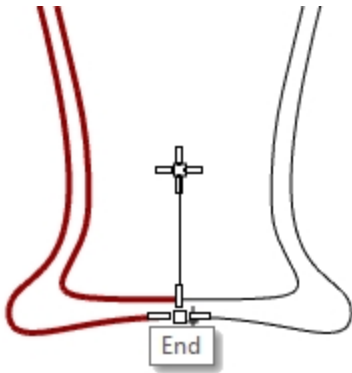

5. For the **End of revolve axis**, select the other end of the curve.
6. To use the default **Start Angle**, press **Enter**.
7. To use the default **Revolution Angle**, press **Enter**.

A surface is revolved around the axis line.



8. Select the free-form curve. (Double check, do not select the surface.)

9. Turn on the **Control Points**.

From the **Edit** menu, click **Control Points** and **Control Points On**.

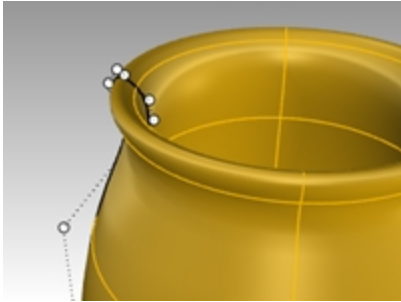

10. With **Gumball** on, highlight a control point and pull to a new position.

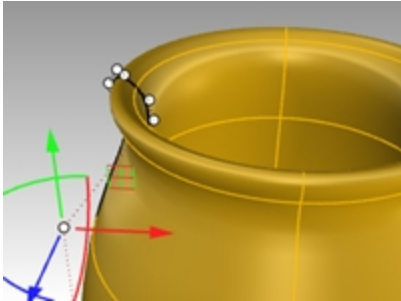

11. The surface will update, as well.

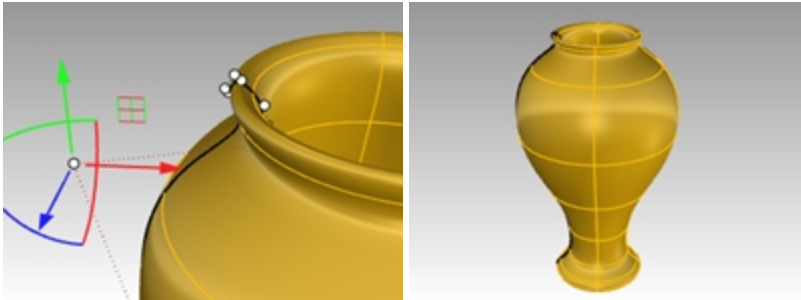

Refer to the **Help** for a list of commands that support History.

## Rail Revolve

The **RailRevolve** command creates a surface by revolving a profile curve of the surface shape around a rail curve that defines the surface edge.

### Exercise 11-5 Rail Revolve—Heart and Star

---

#### Create a rail revolve

1. **Open** the model **Rail Revolve.3dm**.
2. On the **Surface** menu, click **Rail Revolve**.
3. For the **Profile Curve**, select the conic shaped curve (1).



4. For the **Rail curve**, select the heart shaped curve (2).

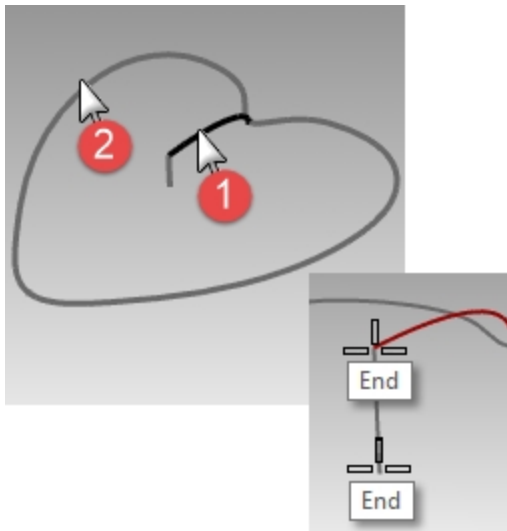

5. For the **Start of revolve axis**, select one end of the vertical line.  
 6. For the **End of revolve axis**, select the other end of the vertical line.

A surface is revolved around the axis while it follows along the curve. The profile curve is scaled in one direction between the axis and the rail.

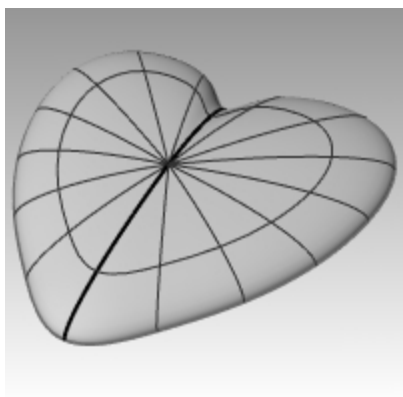

7. Turn the **Bowl** layer on and other layers off.  
 8. Repeat the previous steps to make a bowl.

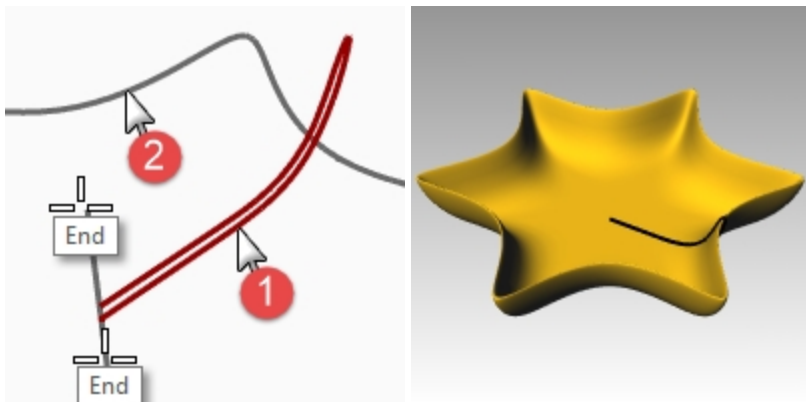

## One-rail sweeps

The **Sweep1** command fits a surface through a series of profile curves that define the surface cross-sections and one curve that defines a surface edge.

The Freeform and Roadlike options determine how the frames along the rail are made.

With the **Freeform** option, the cross-section curve rotates to maintain its angle to the rail throughout the sweep.

With the **Roadlike** option, you can specify an axis for calculating the 3-D rotation of the cross-section.

The default Roadlike axis will be different depending on the rail curve.

- For a planar rail curve, the default axis is perpendicular to the curve plane.
- For a non-planar rail curve, world-Z axis will be used.
- Click the Set axis button to specify a different axis.

## Exercise 11-6 One-rail sweeps

---

In the following exercise, you will create a variety of one rail sweeps with single and multiple cross-section curve inputs. You can also experiment with history and how changing the inputs to drives an updated sweep.

### One cross-section

---

1. Open the model **1 Rail Sweep.3dm**.
2. Select the two curves on the left.

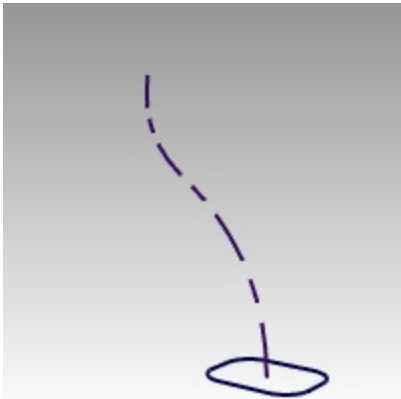

3. On the **Surface** menu, click **Sweep 1 Rail**.
4. In the **Sweep 1 Rail Options** dialog, click **OK**.

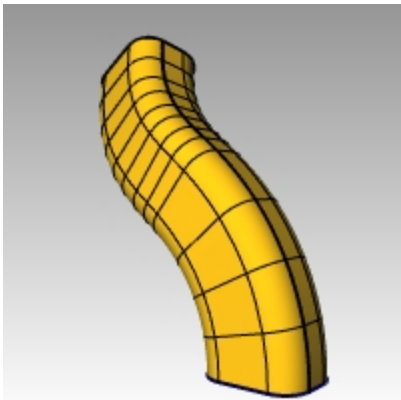

---

**Two cross-sections**

1. Select the three curves in middle.

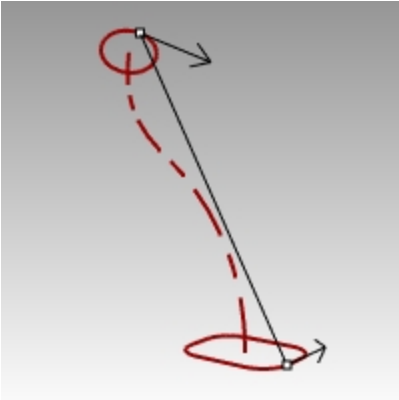

2. On the **Surface** menu, click **Sweep 1 Rail**.
3. In the **Sweep 1 Rail Options** dialog, check **Global shape blending**.
4. In the **Sweep 1 Rail Options** dialog, click **OK**.

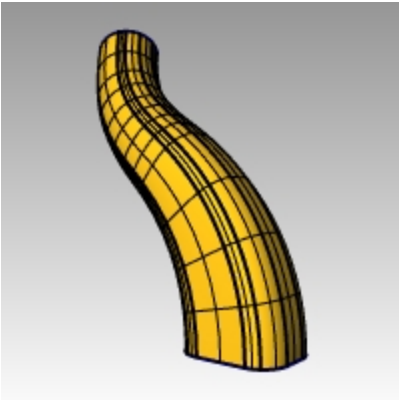

---

**Multiple cross-sections**

1. Select the four curves on the right.

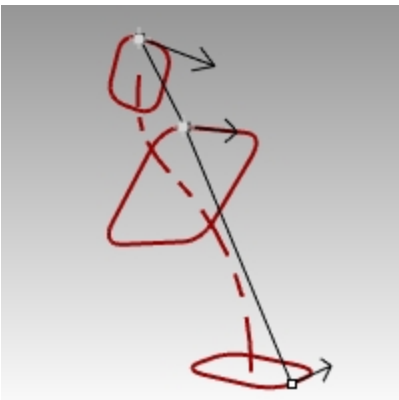

2. On the **Surface** menu, click **Sweep 1 Rail**.
3. In the **Sweep 1 Rail Options** dialog, clear the Global shape blending check box.

4. In the **Sweep 1 Rail Options** dialog, click **OK**.

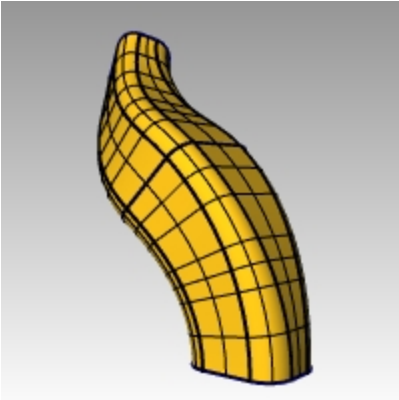

Refer to the *Help* for a definition of the **Global shape blending** option.

### Create a one-rail sweep to a point

1. Make **Surface 02** layer group current, and turn off **Surface 01** layer group.
2. On the **Surface** menu, click **Sweep 1 Rail**.
3. For the **Rail**, select the open free-form curve.

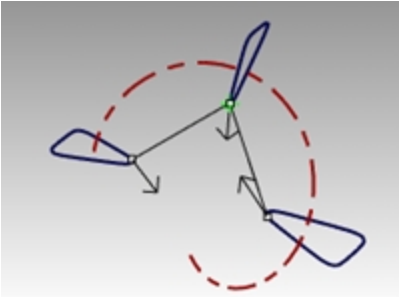

4. For the **Select cross section curves**, select the three closed curves, and in the Command line, click **Point**.

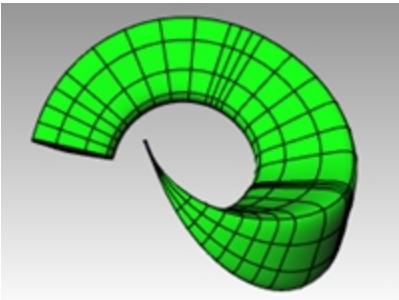

5. For the **Pick end point**, snap to the **End** of the free-form curve. Press **Enter**.
6. In the **Sweep 1 Rail Options** dialog, click **OK**.

### Create a road-like one-rail sweep

1. Make **Surface 03** layer group current and turn off **Surface 02** layer group.
2. Select the helix.

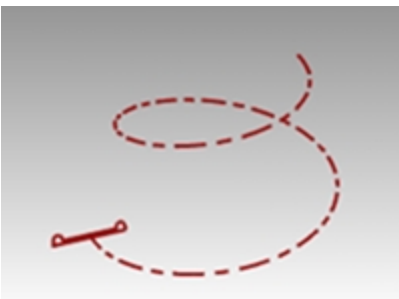

3. On the **Surface** menu, click **Sweep 1 Rail**.

4. For the **Select cross section curves**, select the closed curve and press **Enter**.
5. For the **Drag seam point to adjust**, press **Enter**.

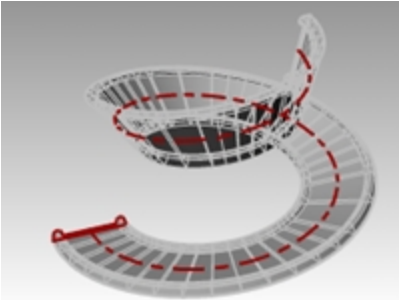

6. Change the style to **Roadlike**. Check the preview of the sweep in the Rhino's **Perspective** viewport.
7. The preview should look correct. Click **OK**.

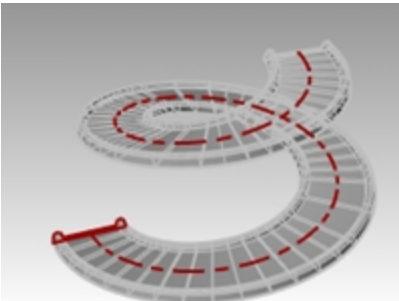

The rail is a non-planar curve, therefore the world-Z is used as the axis for calculating the 3-D rotation of the cross-section.

## Two-rail sweeps

The Sweep2 command fits a surface through a series of profile curves that define the surface shape and two curves that define the surface edges.

### Exercise 11-7 Two-rail sweeps—Rear-view mirror

In the first part of this exercise, we will explore one of the **Sweep2** options. To illustrate the option we will use one cross-section. In the second part we will use the same rail curves with two cross-sections. Lastly, we will use two rails that converge to a single point.



#### Use two-rail sweeps to create the mirror

- ▶ Open the model **2 Rail Sweep.3dm**.

#### Create the base — Part 1

The **Housing Surface** layer is current.

1. On the **Surface** menu, click **Sweep 2 Rails**.
2. Select the two rail curves (1).
3. Select the cross-section curve (2).

4. Press **Enter** twice.

Since we only picked one cross-section, the surface doesn't conform to the circle at the top of the sweep.

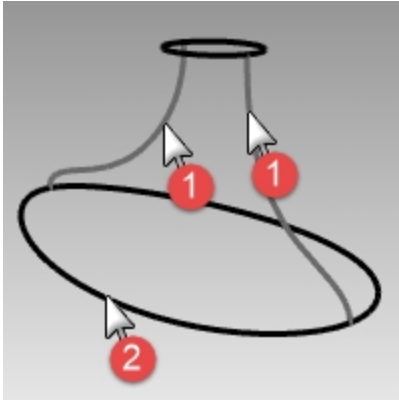

5. In the **Sweep 2 Rail Options** dialog, check **Maintain height**.  
Notice that the cross-section maintains the same height throughout the sweep.
6. In the **Sweep 2 Rail Options** dialog, click **Cancel**.

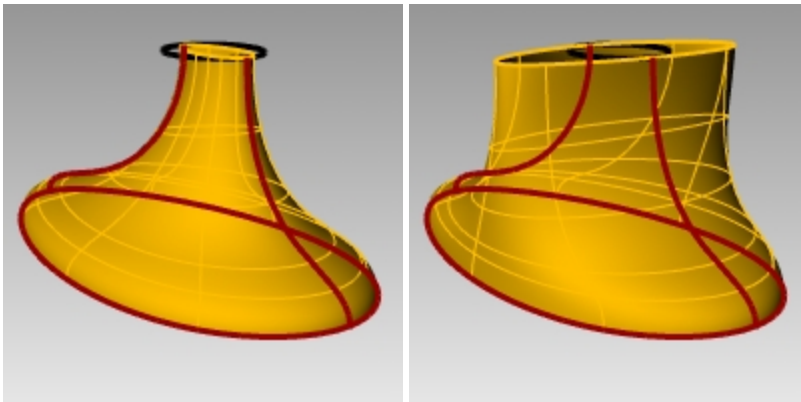

### Create the base — Part 2

1. Select the two rail curves (1).
2. On the **Surface** menu, click **Sweep 2 Rails**.
3. Select both **cross-section curves** (2).
4. Press **Enter** twice.
5. In the **Sweep 2 Rail Options** dialog, click **OK**.  
A surface is created whose edges match the rail curves and the cross-section curves.

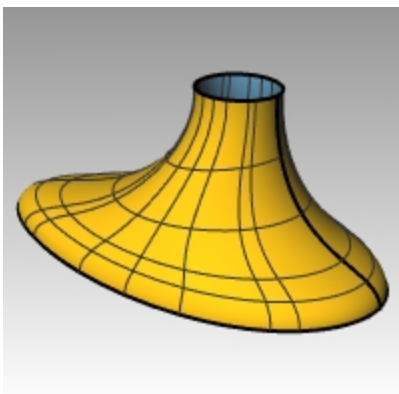

### Create the housing

1. On the **Surface** menu, click **Sweep 2 Rails**.
2. Select the **two rail curves** (1).

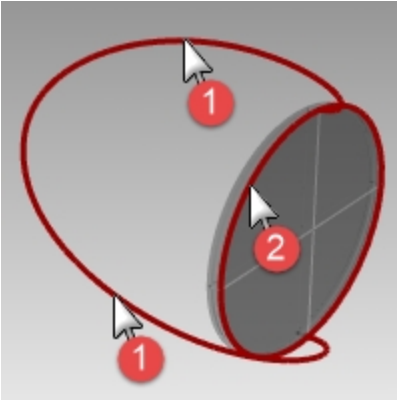

3. For the **cross-section**, select the outer edge of the cylinder, press **Enter** twice.
4. In the **Sweep 2 Rail Options** dialog, click **OK**.  
A surface is created.

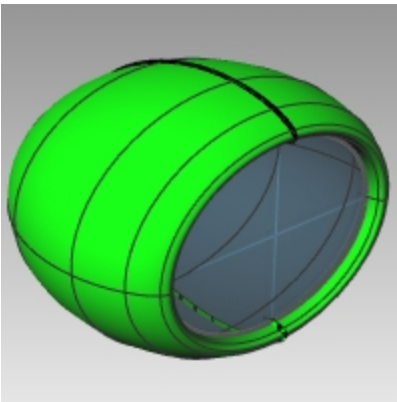

### Join the two parts

1. Select the base(1) and the housing(2) surfaces.

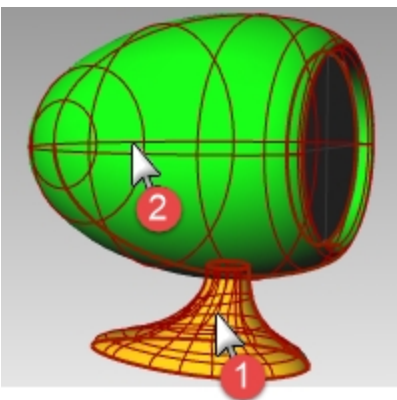

2. On the **Solid** menu, click **Union**.  
The surfaces are unioned into one polysurface.

**Note:** If **Union** does not produce the correct results, try the **Boolean2Objects** command.

- Use **FilletEdge** with a radius of **.25** to round the intersecting edge.

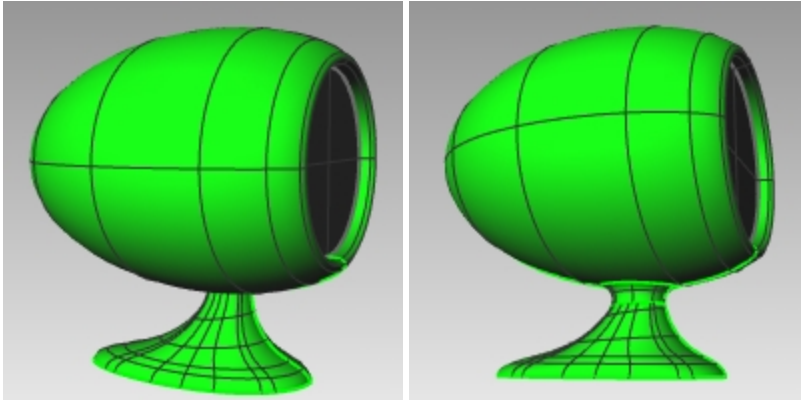

## Network Surface

The **NetworkSrf** command creates a surface from a network of crossing curves. All curves in one direction must cross all curves in the other direction and cannot cross each other. On the Surface menu this command is called **Curve Network**.

### Exercise 11-8 Curve Network - The Side Panel

- Open the model **Networksurf.3dm**.
- On the **Surface** menu, click **Curve Network**.
- For **Select curves in network**, pick the two edge curves and the cross-section curves, and press **Enter**.

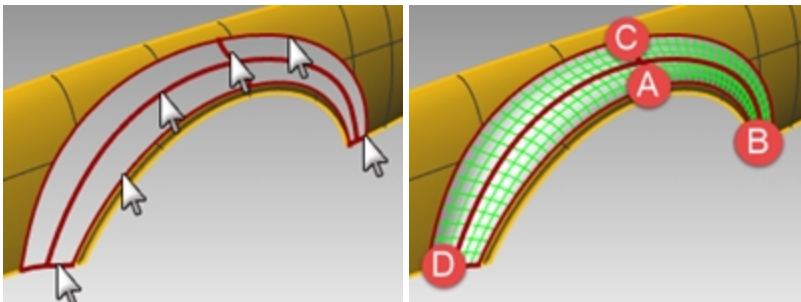

- In the **Surface From Curve Network** dialog box, change the edge matching to **Curvature**, click **OK**.  
A surface is created that has curvature continuity with the other two surfaces.  
Next let's analyze the surface continuity of the joined surface.

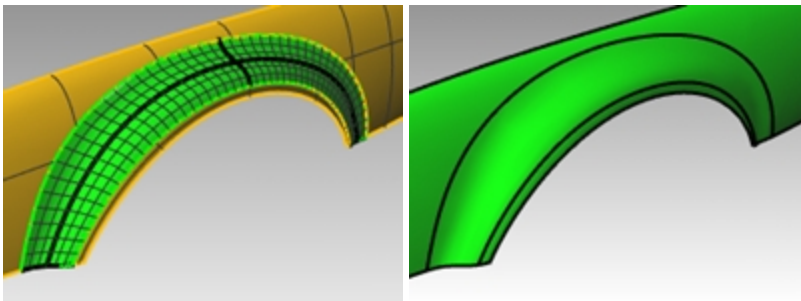

- On the **Analyze** menu, click **Surface**, then click **Zebra**.  
View the stripes where they cross the seams. Notice that they seem to be seamless and smooth.



- On the **Analyze** menu, click **Surface**, then click **Environment map**.  
Try changing the image by clicking the dropdown menu in the **EMap Options** dialog.

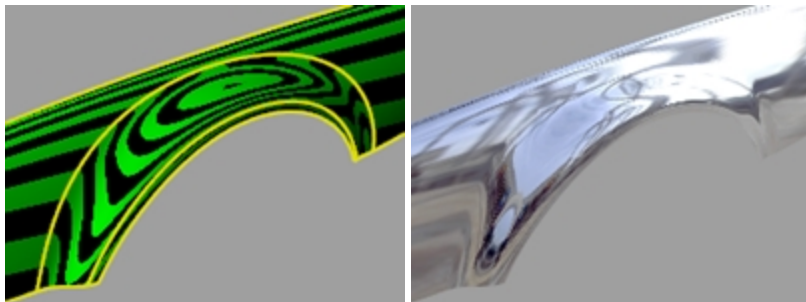

## Exercise 11-9 The Table

In this exercise, you use one rail sweeps to make an end table with free-form tapered legs.

### Create the legs

- Open** the model **Table.3dm**.
- In the **Layer** panel, make the **Leg** layer current.
- On the **Surface** menu, click **Sweep 1 Rail**.
- Select the **path curve** for the leg.

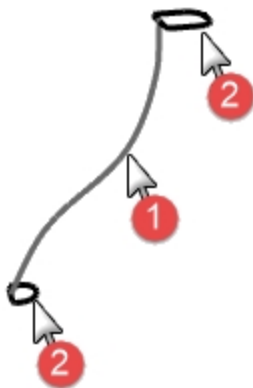

- Select the **shape curve** for both ends of the leg, and press **Enter**.

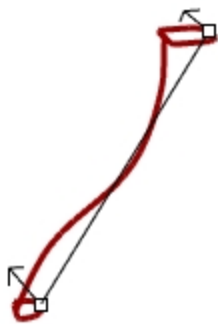

6. In the **Sweep 1 Rail Options** dialog box, click **OK**.

The table leg is created.

**Note** the nice transition from one cross-section curve to the other.

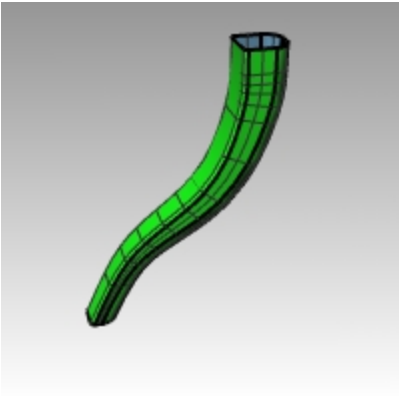

---

### Create the brace

1. Make the **Braces** layer current.
2. Repeat the previous process to create the brace.

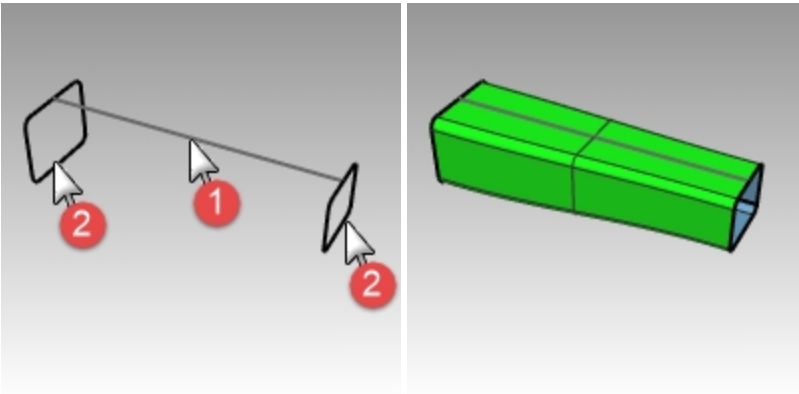

---

### Create the top and finish the table

1. Make the **Top** layer current.
2. On the **Surface** menu, click **Sweep 1 Rail**.
3. For the **Rail**, select the ellipse.
4. For the **Cross-section**, select shape curve.

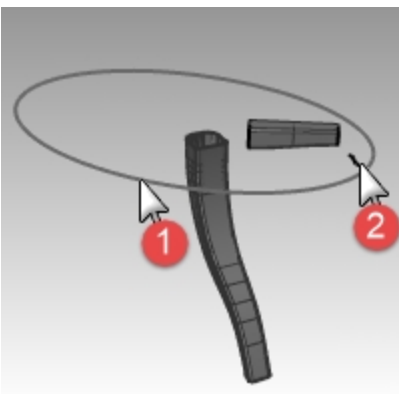

5. Press **Enter**.

- In the **Sweep 1 Rail Options** dialog box, click **OK**.  
The surface for the rim of top is created.

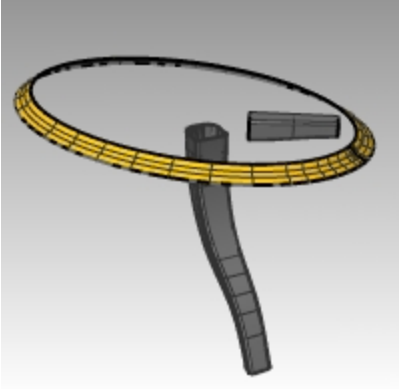

- Select all of the surfaces you created.
- On the **Solid** menu, click **Cap Planar Holes**.  
Six caps were created.
- Use **Mirror** to copy the brace and the leg to finish the model.  
Mirror them around 0,0 in the **Top** viewport.

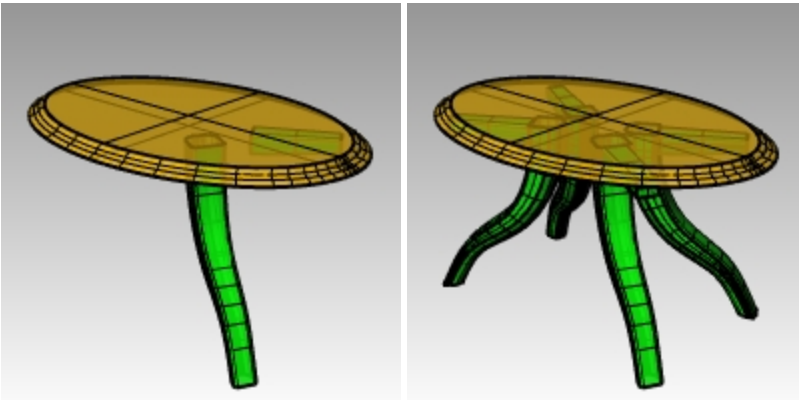

## Modeling techniques—Toy hammer

In this exercise you will use many of the commands and techniques that you've learned in the previous sessions. Commands like **Circle**, **Arc**, **Revolve**, **Sweep1**, **Sweep2**, **BooleanDifference**, **Trim** and more will be need to complete this model. You can also consider rendering it or preparing it for 3-D printing.

Some models require more attention to detail. This is an example of a model that requires precise modeling techniques. This exercise also requires a number of different surface creation techniques. The technical drawing is included to help you create a very precise model.



### Exercise 11-10 The Hammer

1. **Open** the model **Hammer.3dm**.

The following layers have been created: Construction Lines, Curves, Handle, Tang, Head, Hole, Cutout, and Claw. Use the appropriate layer when constructing the model.

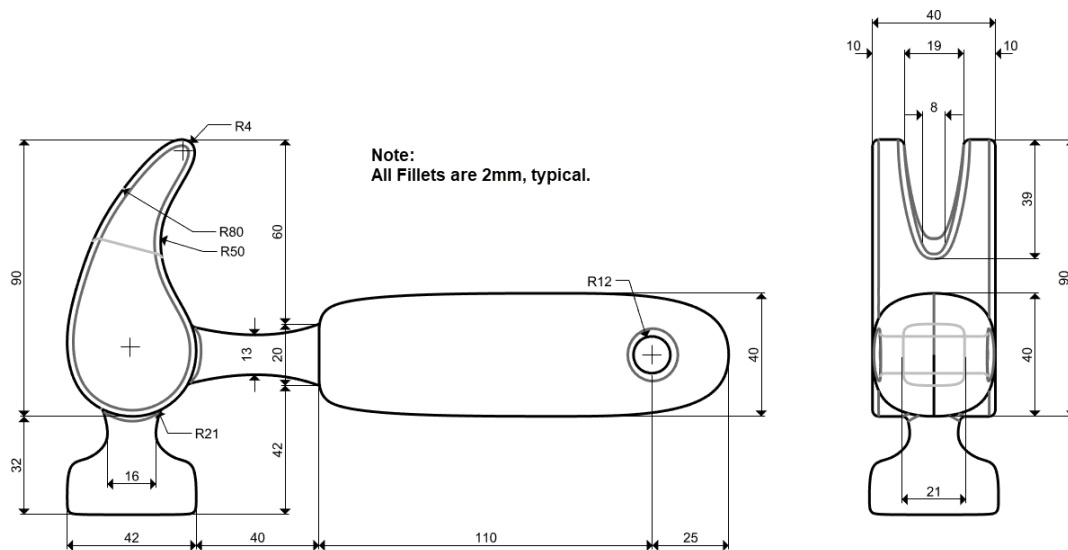

2. In the **Top** viewport, draw outlines for the hammer.

Drawing outlines helps while drawing the curves. You can either draw lines, polylines, or rectangles to create the outlines. Use the dimensions on the technical drawing to get accurate outlines.

**Note:** The Hammer model contains an existing layer with the construction lines for the this model already created called **Construction Lines**. There is a sublayer with centerlines that should also be helpful. Turn these layers on to speed up the exercise. Or create your own construction geometry for additional practice and a more realistic approach.

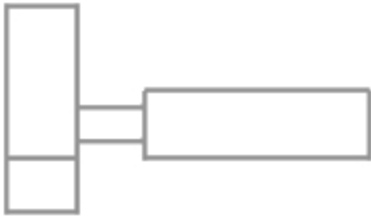

- All Fillets are 2mm, typical, unless otherwise noted.

### Add the Picture

In the **Front** view use the **Picture** commands to attach the **Hammer\_mm.png**. It will make it easy to reference the dimensions while modeling.

- Make the **Front** viewport current.
- On the **Surface** menu, under **Planar** click **Picture**.
- In the **Open Bitmap** dialog, navigate to your class files folder and select the **Hammer\_mm.png**.
- Pick the **First corner of picture** and then the **Other corner** to get the length of the image.
- Highlight the picture and using the Gumball, move the surface back behind the curves.

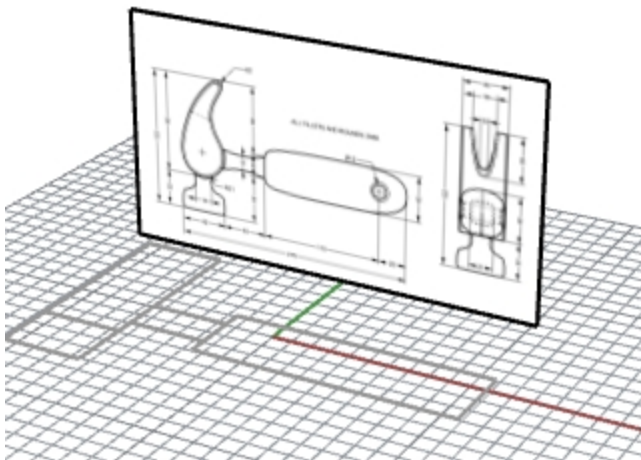

- Highlight the picture and in the **Properties** panel, pick the **Materials** page.
- Under the Picture section, drag the **Object transparency** slider to 50%.  
This will fade the picture, and make it easier to see the object lines that you will add next.

### Create the claw

When modeling the shape of the claw, you will use circles, arcs, and curves. You can trim the circles and arcs and then join them together to create a closed curve. You can rebuild the curve and adjust the control points to get a more sculptural shape.

- Change to the **Curves** layer.
- In the **Top** viewport, draw a curve defining the shape of the claw.  
You can use a free-form curve or use a combination of arcs and circles that are trimmed and joined to create the curve. Following is a systematic approach to creating the curve for the claw part of the hammer using arcs and circles.  
Start by drawing two circles.
- Use the **Circle** command (*Curve menu > Circle > Tangent to 3 curves*) to create a circle at the lower end of the claw.  
Draw the circles tangent to the construction geometry

4. Use the **Circle** command (*Curve menu > Circle > Tangent, Tangent, Radius*) to create a circle at the upper end of the claw that is tangent to the upper right corner with a **4 mm** radius.  
Draw the circles tangent to the construction geometry.

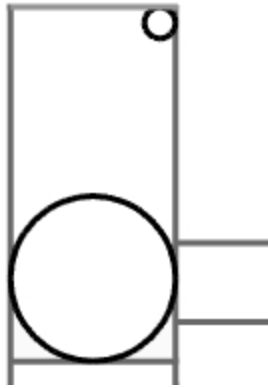

5. Use the **Arc** command (*Curve menu > Arc > Tangent, Tangent, Radius*) to create arcs that are tangent to the two circles.

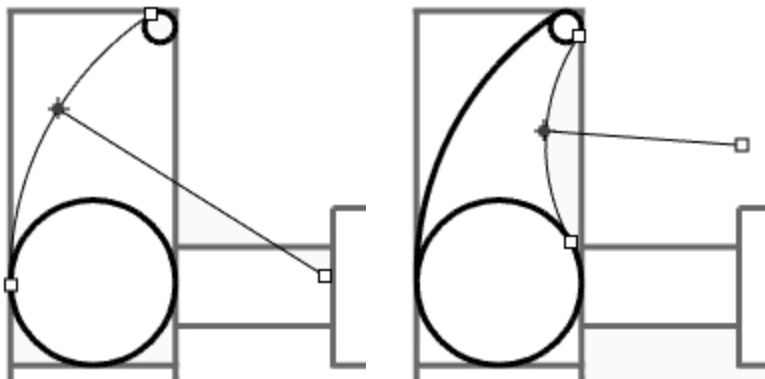

6. Use the **Trim** command (*Edit menu > Trim*) to trim the inside part of the circles.
7. Use the **Join** command (*Edit menu > Join*) to join the arc segments.



8. Make the **Claw** layer current.
9. Select the joined segments.

- Use the **ExtrudeCrv** command (*Solid menu > Extrude Planar Curve > Straight*) to extrude the curve on both sides of the construction plane.

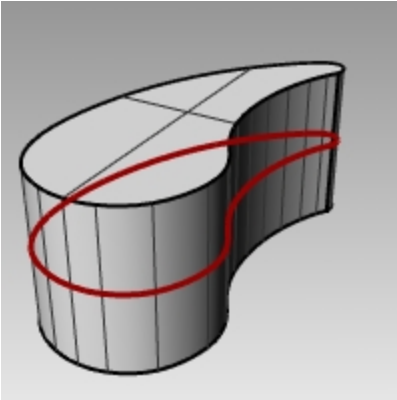

### Create the head

- Make the **Curves** layer current.
- Use the **Curve** command (*Curve menu > Free-form > Control Points*) to create the curve for the cross-section of the head.

Make sure the curve intersects the claw part. This makes joining the two pieces easier.

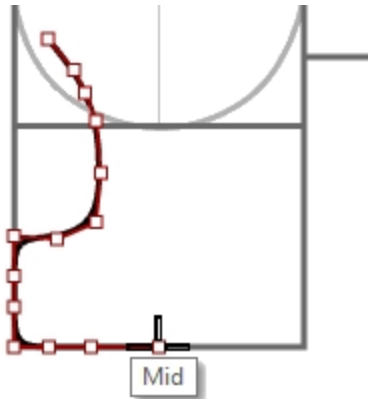

- Make the **Head** layer current.
- Use the **Revolve** command (*Surface menu > Revolve*) to revolve the curve. Use the midpoint of the construction line for the revolve axis.

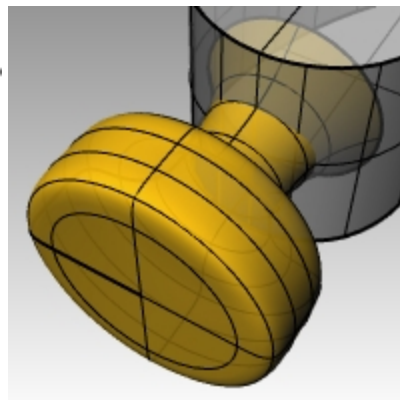
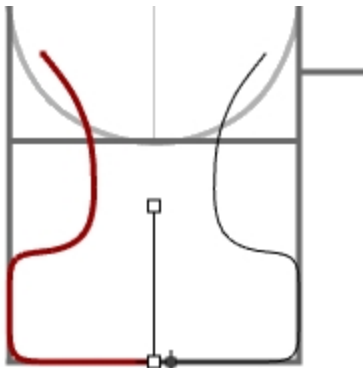

- Save your model.

### Add the head to the claw part

- Use the **BooleanUnion** command (*Solid menu > Union*) to join the head with the claw. If the result is not correct, flip the normal of the head surface with the **Dir** command. The normal of the head surface should be pointing outwards.

- Use the **FilletEdge** command (*Solid menu > Fillet Edge > Fillet Edge*) fillet the intersection between the head and the claw.

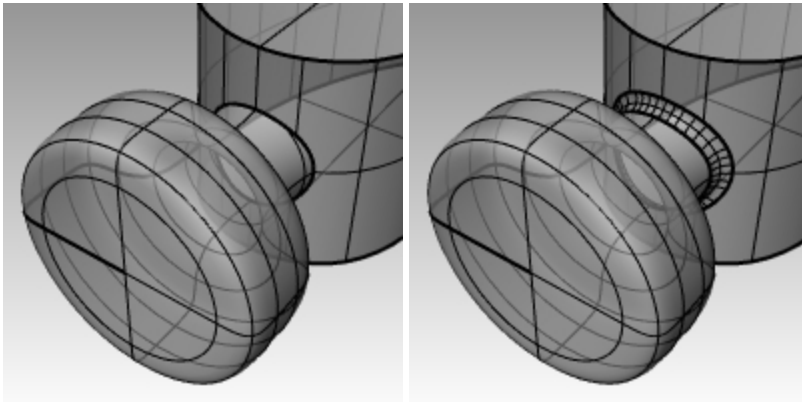

- Save your model.

### Create slot for the claw part of the hammer

- Use the **Curve** command (*Curve menu > Free-form > Control Points*) to draw a curve for the slotted part of the claw.  
Make sure the curve is symmetrical.
- Use the **Line** command (*Curve menu > Line > Single Line*) to draw a line between the endpoints.
- Use the **Join** command (*Edit menu > Join*) to join the curve and the line.

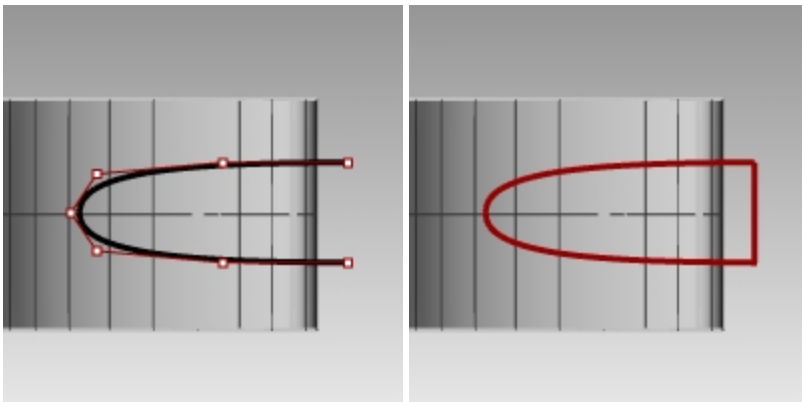

- Drag the closed curve closer to the claw.
- Use the **Rotate** command (*Transform menu > Rotate*) or gumball to rotate the curve to align more closely with the curve of the claw.

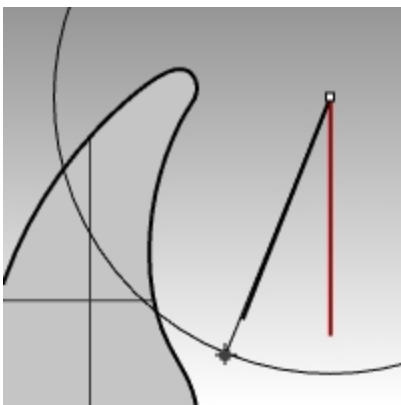

- Make the **Claw** layer current.



- Use the **ExtrudeCrv** command (*Solid menu > Extrude Planar Curve > Straight*) to extrude the curve through the claw.

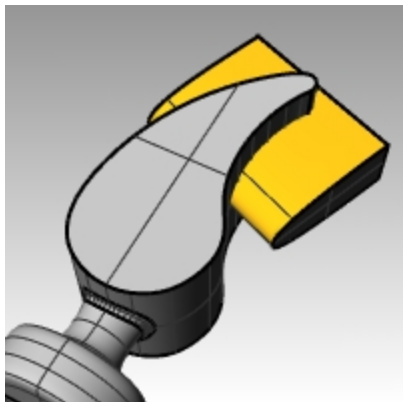

- Save your model.
- Use the **BooleanDifference** command (*Solid menu > Difference*) to subtract the slot from the claw.

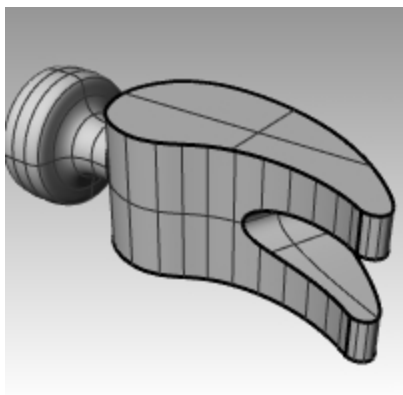

- Use the **FilletEdge** command (*Solid menu > Fillet Edge*) to make the fillets around the top and bottom of the claw, and the slot.

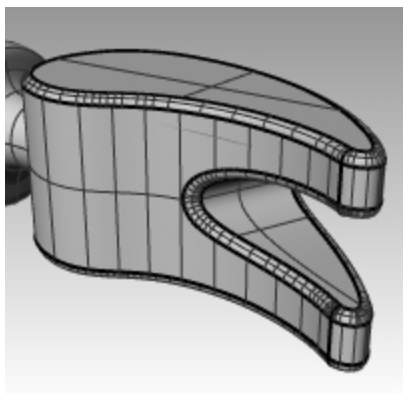

### Create the shape curve for the tang and the handle

Create the shape curve for the tang in the **Right** viewport. This curve will also be used for the handle.

- Make the **Curves** layer current, and turn on **Ortho**.

- Use the **Curve** command (*Curve menu > Free-form > Control Points*) to draw a curve for the upper cross-section of the tang. Make sure the curve is symmetrical.

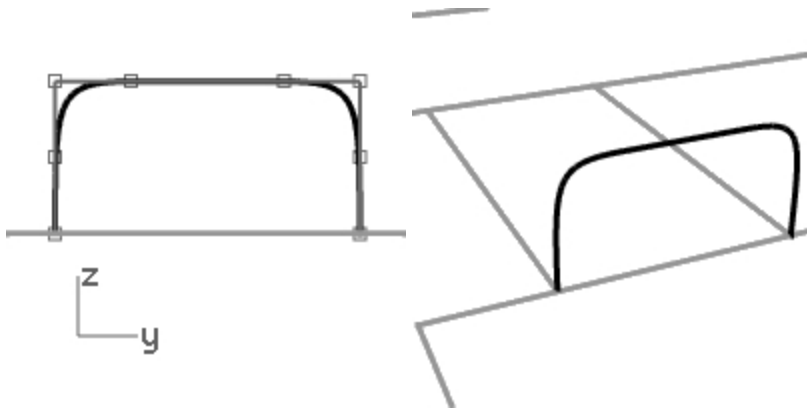

- Use the **Mirror** command (*Transform menu > Mirror*) to create the other curve.

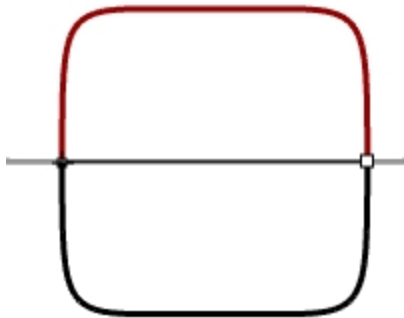

- Use the **Join** command (*Edit > Join*) to join the curves.
- Save** your model.

### Create the tang

- Use the **InterpCrv** command (*Curve menu > Free-form > Interpolate Points*) to draw one of the curves for the tang of the hammer. Make sure that it intersects the claw.

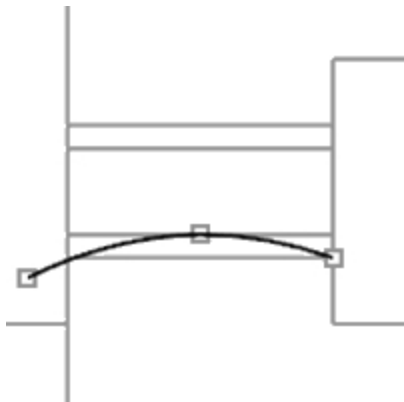

- Use the **Mirror** command (*Transform menu > Mirror*) to create the other curve.

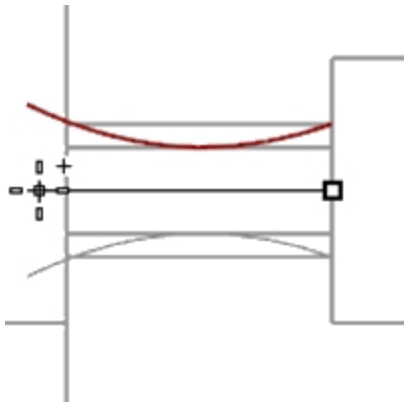

- Make the **Tang** layer current.
- Use the **Sweep2** command (*Surface menu > Sweep 2 Rails*) to make the surface.
- Use the **Cap** command (*Solid menu > Cap Planar Holes*) to make the tang a closed polysurface.

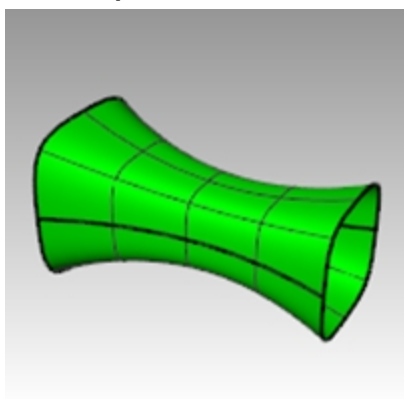

- Save** your model.

#### Finish the hammer head

- Select the tang and the claw.

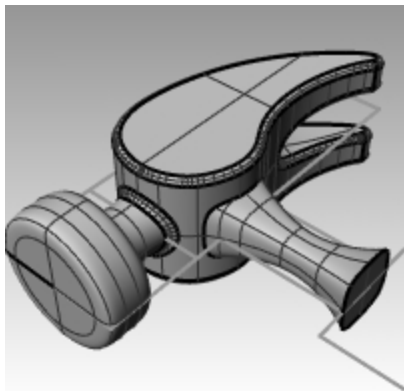

- Use the **BooleanUnion** command (*Solid menu > Union*) to join the tang with the claw and the head.
- Use the **FilletEdge** command (*Solid menu > Fillet Edge*) to make the fillets at the intersection between the tang and the claw.  
The edge has a round on it.
- Save** your model.

### Create the handle

---

1. Make the **Curves** layer current.
2. Use the **Curve** command (*Curve menu > Free-form > Control Points*) to draw a curve for the top edge of the handle.  
Make it start at the endpoint of the tang profile curve and end on the center line.



3. Use the **Mirror** command (*Transform menu > Mirror*) to make the other half.



4. Make the **Handle** layer current.
5. Use the **Sweep2** command (*Surface menu > Sweep 2 Rails*) to make the surface using the tang curve as the profile curve.

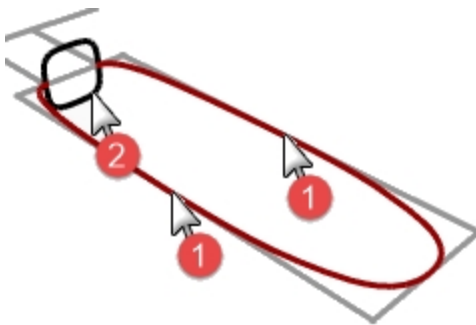

A surface is created.

6. Use the **Cap** command (*Solid menu > Cap Planar Holes*) to cap the open end.

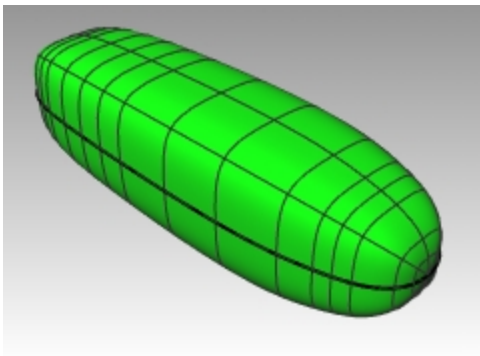

7. **Save** your model.

### Create the hole for the handle

1. Use the **Circle** command (*Curve menu > Circle > Center, Radius*) to make a circle 25mm from the end of the handle.

You may have to draw a construction line to help you position the circle.

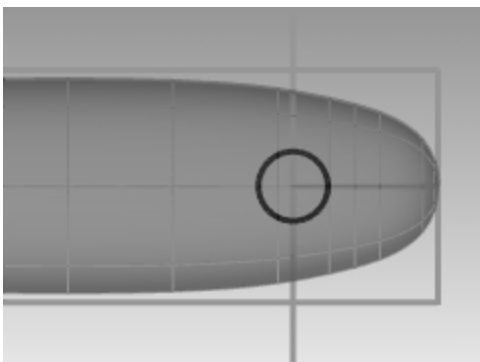

2. Use the **ExtrudeCrv** command (*Solid menu > Extrude Planar Curve > Straight*) to extrude the curve on both sides of the construction plane.

Make sure the extrusion intersects both sides of the handle.

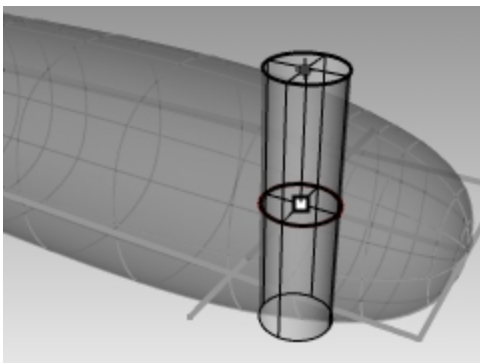

3. Use the **BooleanDifference** command (*Solid menu > Difference*) to subtract the hole from the handle.

4. Use the **FilletEdge** command (*Solid menu > Fillet Edge*) to make the fillets at the edges of the hole. The edges have rounds on them.

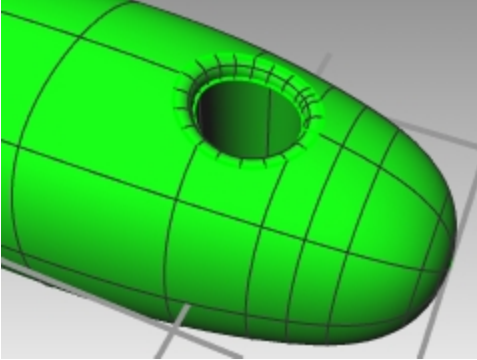

5. **Save** your model.

## Precision modeling

Some models require more attention to detail. This is an example of a model that requires precise modeling techniques. This exercise also requires a number of different surface creation techniques.

The technical drawing is included to help you create a very precise model.

### Exercise 11-11 — The Squeeze bottle

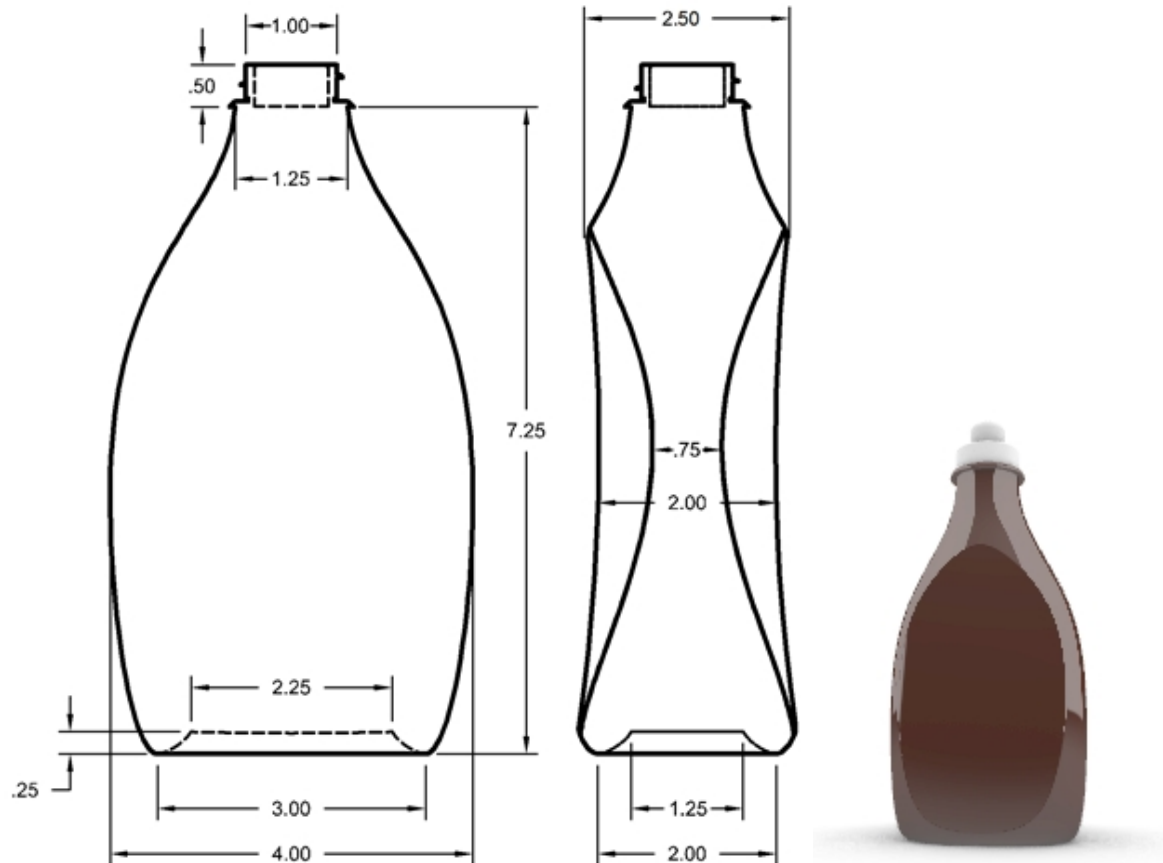

#### Creating a squeeze bottle

1. **Open** model **Squeeze Bottle.3dm**.
2. Use the pre-drawn rectangle to create a circle, an ellipse, and a profile curve. These curves will be used to generate the surfaces of the bottle.

**Note:** A set of these curves is already included in the model as **Bottle\_curves** and **Path\_curves**. These layers are sublayers of a layer named Curves.

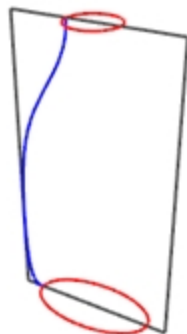

3. Make another (smaller) **ellipse** that will be used for the concave part at the bottom of the bottle.

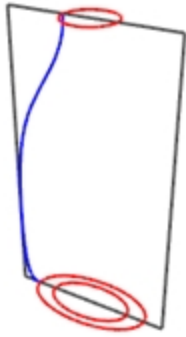

4. **Move** this ellipse vertically **.25** units.

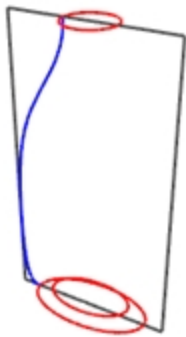

---

### Create the surfaces for the bottle

1. Change to the **Bottle\_surface** layer and turn off the **Reference** layer.
2. Select the small ellipse.
3. Use the **PlanarSrf** command (*Surface > Planar Curves*) to make a flat surface.

**Bottle\_surface** is a sublayer of **Surfaces**

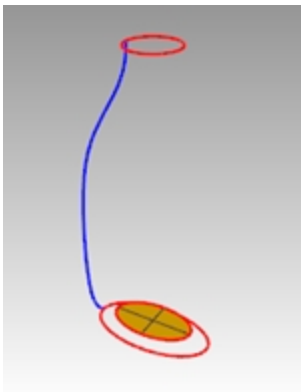

4. Select the large ellipse and the circle.
5. Start the **Sweep2** command (*Surface > Sweep 2 Rails*).  
The pre-selected ellipse and circle will be the rails for the sweep.
6. For the **Select cross section curves**, choose the profile curve, and then press **Enter**.



7. In the **Sweep 2 Rail Options** dialog box, click **Do not change cross sections**. This option will create the sweep without altering the cross-section curves. Also check **Closed sweep**, and then click **OK**.

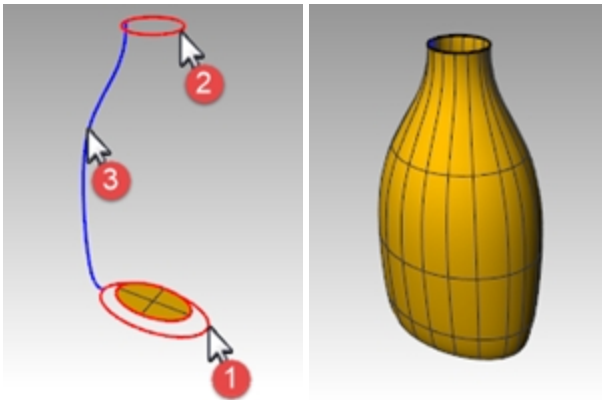

### Create a blend surface for the bottom of the bottle

1. **Hide** the rail and profile curves.
2. Start the **BlendSrf** command (*Surface > Blend Surface*).
3. For the **Segment for first edge**, select the edge of the ellipse surface, and then press **Enter**.
4. For the **Segment for second edge**, select the edge of the bottle surface, and then press **Enter**.

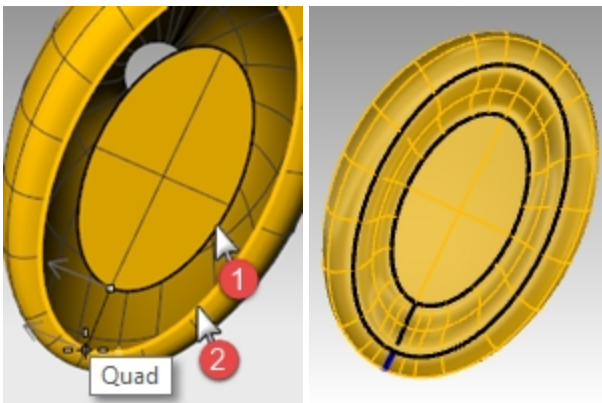

5. For the **Drag seam point to adjust**, move the seam points so that they align with each other, and press **Enter**.
6. In the **Adjust Surface Blend** dialog, preview the sweep. Make any adjustments that are necessary and then click **OK**.
7. **Join** the three surfaces.

**Hint** In the **Display** panel, you can enable **Object settings** and **Color Backfaces** in your current display mode. Pick a **Backface color** like cyan that will easily identify the normal direction of the surface and any openings in your polysurface.

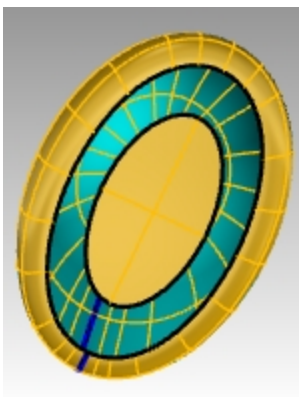

*Shaded display mode image with a backface color set to cyan*

### Cap the top

If you close the bottle, thereby creating a solid, Rhino can calculate the bottle's volume. If you were creating this bottle in real life, knowing the volume would be important. Normally, a bottle would have to be designed to hold a specified volume.

If the edges of the remaining open surfaces are planar curves, you can use the **Cap** command to close them. The open edges on the bottle are the top circular shape and the bottom elliptical shape, and they are planar.

### Cap the top and bottom

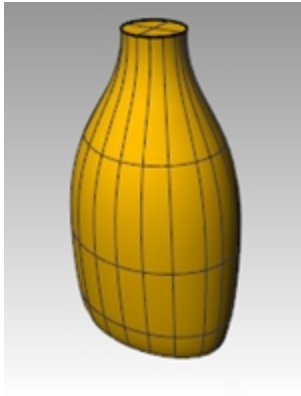

3. Select the surface.
4. Use the **Cap** command (*Solid menu > Cap Planar Holes*) to close the holes.

### Making the Surface for the Label

In this part of the exercise, you will create custom surfaces to trim an area on each side of the bottle for a label. The new surface will have curvature in only one direction.

**Note:** A set of these curves is already included in the model on layer **Label\_Surface\_Curves**, a sublayer of the **Curves** layer.

### Create the trimming surface

---

1. Make the **Label\_Surface\_Curves** layer current.
2. In the **Front** viewport, draw two lines.  
One line in the middle and one on the side.  
Make sure the lines extend a little below and above the height of the bottle.

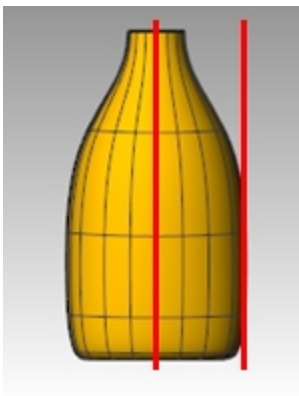

- In the **Right** viewport, **Move** the lines so that they will intersect the bottle, like the illustration on the right.

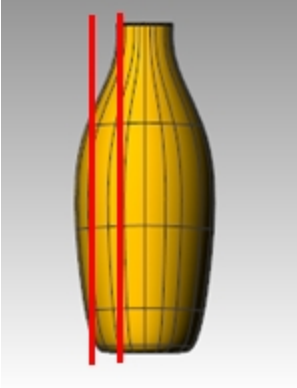

- Mirror** the line on the side to the other side of the bottle.  
These lines will be used to create a cutting surface for the flat side of the bottle.
- Make the **Label Surface** layer current.
- Select the three curves you just created.

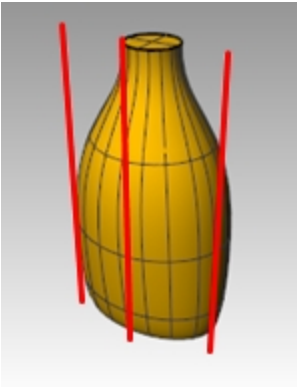

- Use the **Loft** command (*Surface menu > Loft*) to make the cutting surface.
- In the **Loft Options** dialog, clear the **Closed loft** check box, and click **OK**.  
A lofted surface intersects the bottle.

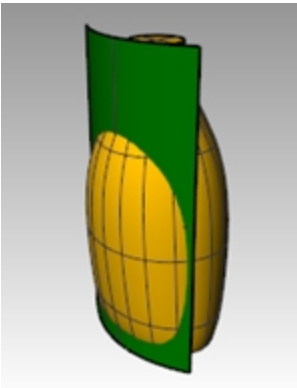

9. **Mirror** the surface to the other side of the bottle.

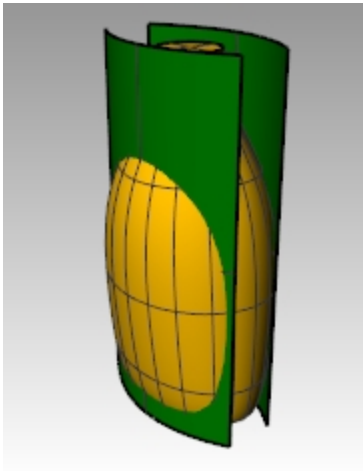

10. **Save** your model.

#### Remove the surface from the bottle

---

1. Change to the **Bottle Srf** layer.
2. Use the **Dir** command (*Analyze menu > Direction*) to check the surface normal direction.  
Flip the normals if necessary.  
The normals should be pointing toward the center of the bottle.
3. Select the bottle.

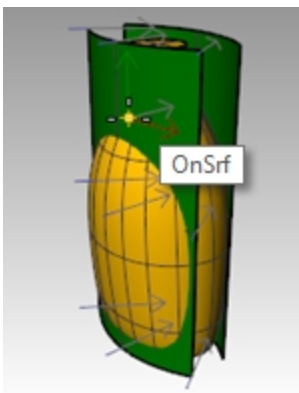

4. Use the **BooleanDifference** command (*Solid menu > Difference*) to subtract the two lofted surfaces from the bottle.

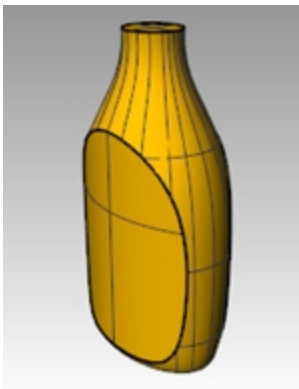

5. To create a hollowed out shell from a solid polysurface, like this bottle, use **Shell**.  
At the command prompt, type **Shell**.

- Pick the top surface as the surface to remove.

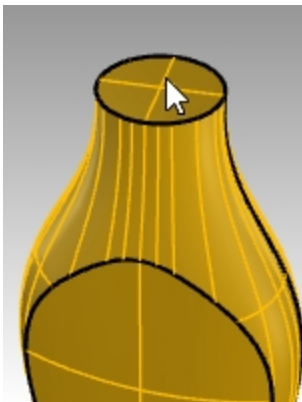

- Use a shell thickness of **.05mm**. You may experiment with other shell thicknesses.
- Enter** to Shell the bottle.

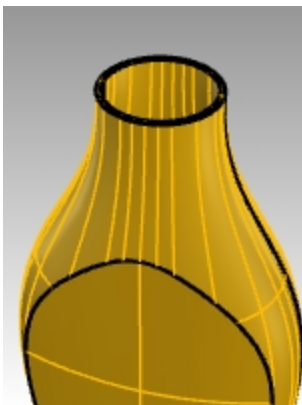

- Use the **What** command to check the geometry. After the Shell, it should still be "valid and closed polysurface." If not, **Undo** and use a thinner shell. Use the **ShowEdges** with the *Naked* option to determine where the opening have occurred.  
**Shell** only operates on simple, solid, manifold polysurfaces. For more information on this command view the **Shell** Help topic.
- Turn on the **Bottle Srf** layer

### Create the bottle's top

To create the bottle top, you are going to revolve a profile curve to create the surface.

#### Create the thread curve

- Turn on the **Top\_Detail\_curves** layer and make the **Neck\_Curves** sublayer current.

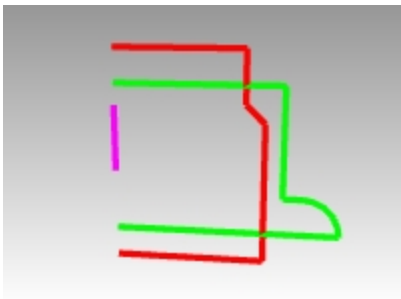

- On the **Curve** menu, pick **Helix**.
- Pick the **AroundCurve** option in the Command line.

- Pick the magenta curve as the axis for the helix.

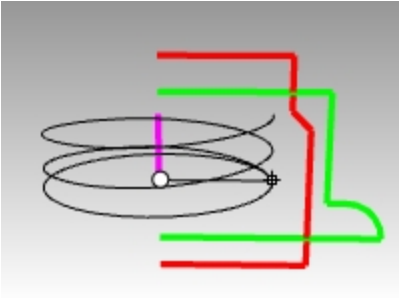

- In the Command line, set Helix options: **Set Mode=Turns, Turns=2 and ReverseTwist=No.**
- In the **Front** viewport, snap the radius to the green profile curve.

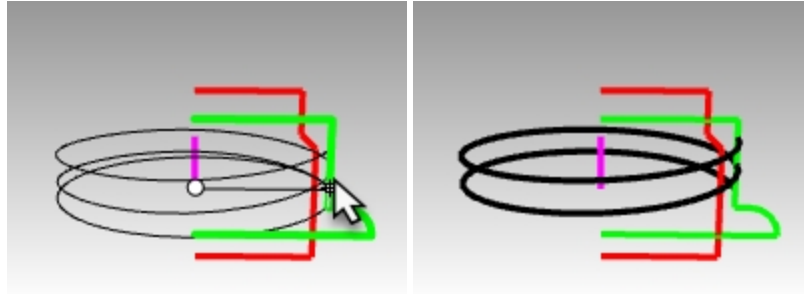

#### Extend and scale the thread curve

To allow the thread to ramp smoothly at each end instead of starting and stopping abruptly, here you will extend the helix and scale it inward towards the middle of the bottle's neck.

- On the **Curve** menu, pick **Extend Curve** and **Extend Curve**.
- Enter** to dynamic extend.
- Pick on one end of the helix.
- Set the extension **Type=Smooth** or **Type=Natural**.
- Type **.5**, and **Enter** to extend the curve smoothly .5 units.

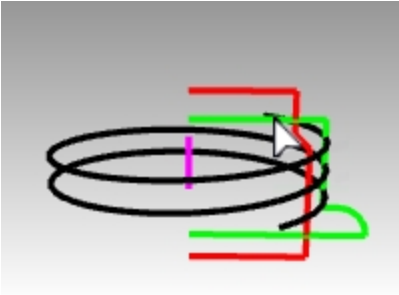

- Click on the other end of the curve and repeat the **.5** unit extension. The command keeps running after the first extension so you do not need to start it again. **Enter** or **Esc** after the second extension to end the command.

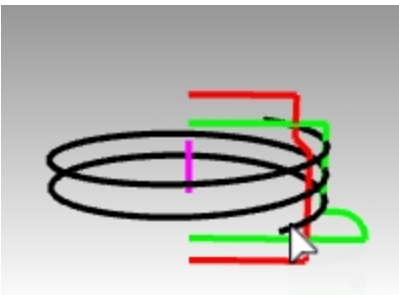

- Select the red and green curves. From the **Edit** menu, pick **Visibility** and **Hide**. (They will be turned back on with the **Show** command later in this exercise.)
- Turn on control points for the helix with the **PointsOn** command.

- Select the control points at both ends.

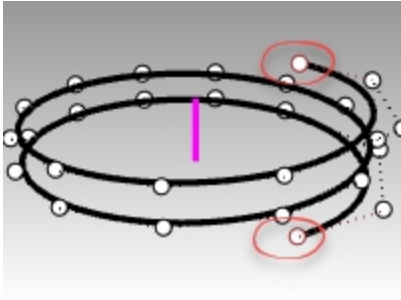

- From the **Transform** menu, pick **Scale** and **Scale2D** command.
- In the **Top** viewport, set the base of the scale to the CPlane origin by typing in 0 and **Enter**.
- For the scale factor, type **.85**.  
The location of the end points will scale towards the origin, and the ends of helix will be reset.

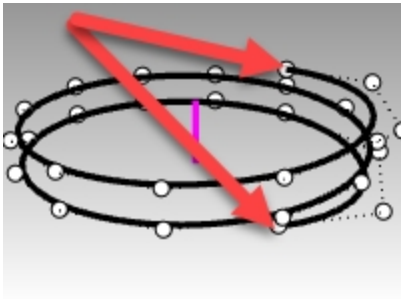

### Orient the curve

Now you will place the thread profile on our newly extended helix.

- On the **Transform** menu, pick **Orient** and the **OrientOnCrv** command.
- In the **Top** viewport, select the small triangle at the origin as the object to orient.

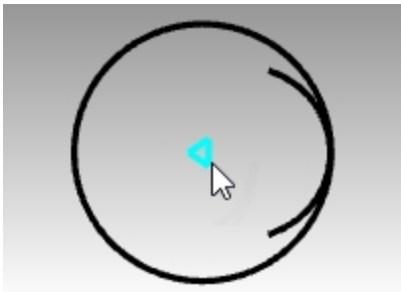

- In the **Top** viewport, set the base point at the origin by typing **0** and **Enter**.  
This will be the point, in the middle of the triangle, that is mapped to the orientation curve.
- Select the helix as the Orientation curve very close to one of the ends.  
You will only need one curve oriented at one of the ends of the helix.  
An **End point** osnap will be used here to snap exactly at the end of the helix.
- You will see the preview of the triangle floating with the cursor along the helix. Set the options **Copy=Yes**, click the **Perpendicular**.

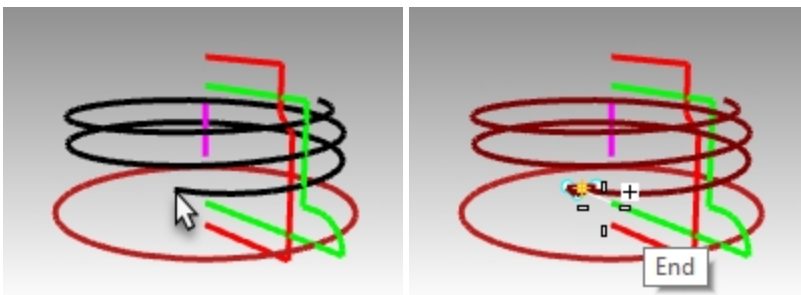

6. Next click **XFlip=Yes** only if the point of the triangle is not oriented to the outside of the helix.  
**Note** With **XFlip=Yes** the curve to orient flips itself perpendicular to the curve on the axis you specify.  
 Toggle the Xflip setting and choose the one that previews the point of the triangle oriented to the outside of the helix.

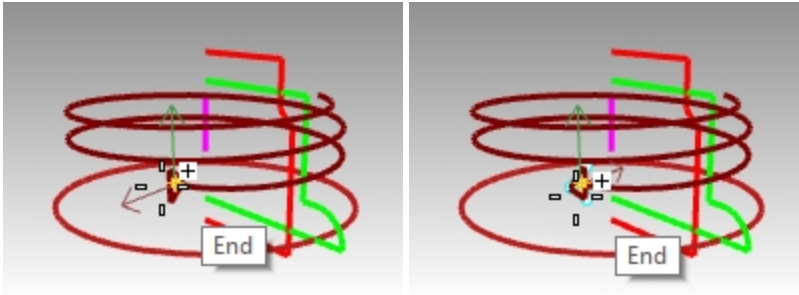
*XFlip required.**Desired orinetation.*

7. Click at the end of the helix curve to place the triangle.  
 8. Preview the result in the Rhino viewport and **Enter**.  
 Now everything is in place to create the thread surfaces.

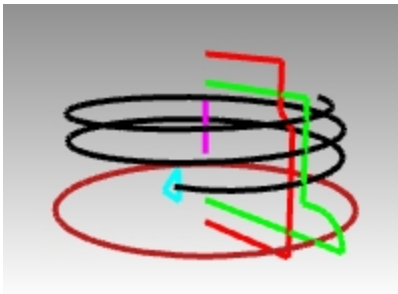

### Sweep the curve

Now you will sweep the thread profile curve located on the end of the extended helix to create the thread surface.

1. Make the **Neck\_surface** layer current.
2. From the **Surface** menu, pick the **Sweep1** command.
3. Select the helix as the path curve, the triangle at one end as the shape curve.
4. With the **Perspective** view active, set the sweep style to **Roadlike** to ensure that the profile maintains its orientation correctly for a vertical thread as it sweeps around.

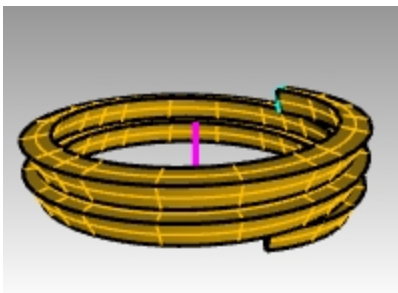

5. Make any adjustments that are necessary and then click **OK**.
6. Highlight the swept surface and from the **Solid** menu pick **Cap Planar Holes**. Cap makes the resulting sweep closed at the open ends and solid.

### Union the neck

To make the neck itself, you will revolve the two vertical curves to create solids and combine them into a closed solid with two Boolean operations.



1. From the **Edit** menu, pick **Visibility** and **Show**.
2. From the **Surface** menu, pick **Revolve**.
3. Select the green vertical curve as the curve to revolve.

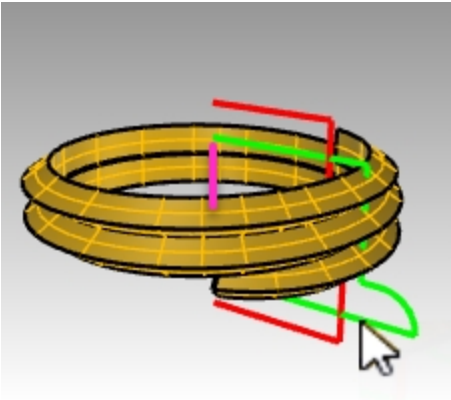

4. Set the axis to the origin **0** of the Top CPlane and press **Enter** to use the CPlane z-axis direction. Or pick the end points of the magenta line, indicating the revolve axis.

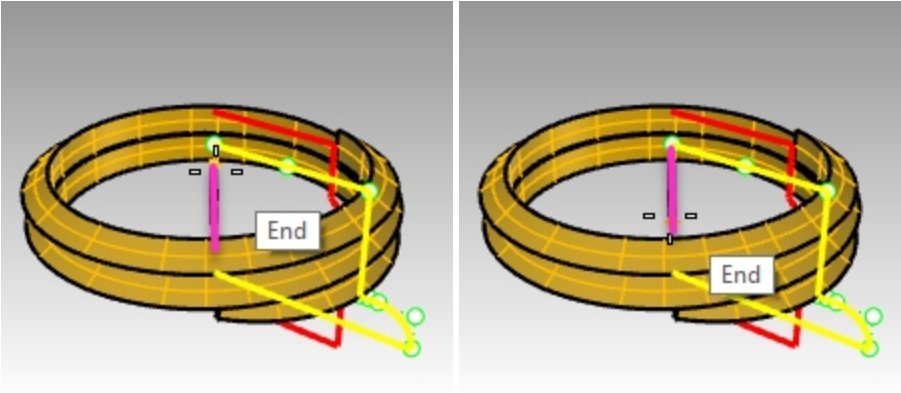

5. Pick **Full circle** option in the Command line.

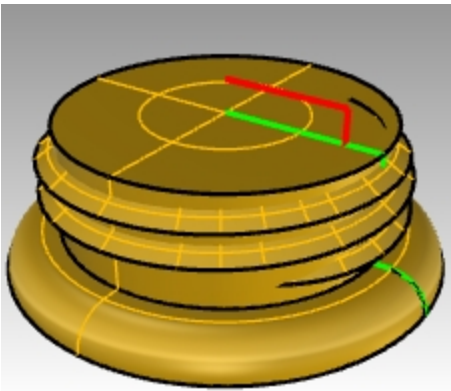

6. From the **Solid** menu, pick **BooleanUnion**. Select the thread solid and the revolved solid.

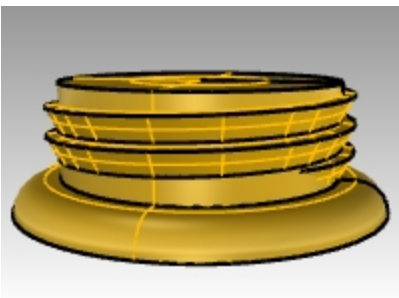

7. Hide the threaded neck which resulted from the **BooleanUnion**.

## Difference the opening

1. Make the **Plug** layer current.
2. Select the red vertical curve.

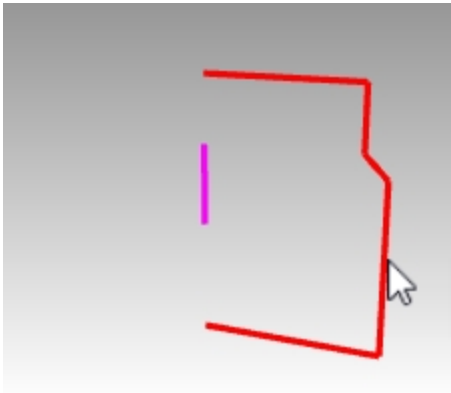

3. From the **Surface** menu, pick **Revolve**.
4. At the **Start of revolve axis** type **0** and **Enter**.
5. In the Top CPlane and press **Enter** to use the default option of the CPlane z-axis direction.  
**Option:** Pick the end points of the magenta line, indicating the revolve axis.

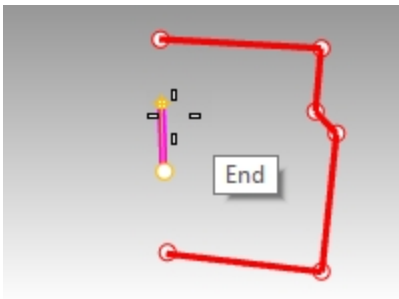

6. Pick **Full circle** option in the Command line.

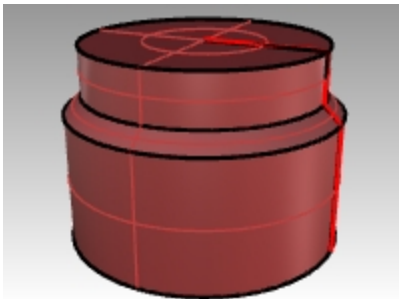

7. **Show** the threaded neck.

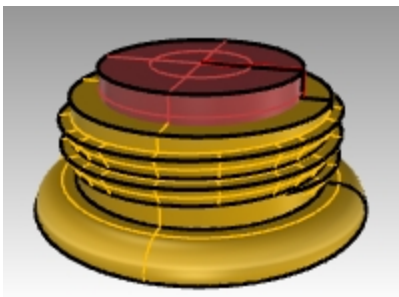

- From the **Solid** menu, pick **BooleanDifference**. Select the thread solid and  Enter. Next pick the last revolve and  Enter.

The revolved surface is not subtracted from the solid thread, resulting in a new solid neck for the bottle.

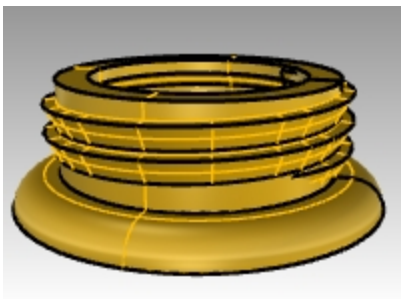

### The whole bottle

Now you will put both pieces together.

- Turn on the **Bottle Srf** layer and make it current.
- From the **Solid** menu, pick **BooleanUnion**. Select the bottle solid and the neck solid. Press  Enter to union them into one closed solid.

### Fillet the bottle

Soften the transition between the label surface and the bottle.

- From the **Solid** menu, pick **Fillet Edge** and **Fillet Edge**.
- Type **.25** as the fillet radius and  Enter.
- Select the curve that defines the transition between the label surface and the bottle.
- Enter twice to exit the command.



- Repeat for the other side of the bottle.

### Rendering the bottle

Render the bottle with plastic materials. Place lights.



### Adding a decal

Use Decals to attach a label to the front of the bottle.

1. In the **Properties** panel, on the **Decal** page, click the "+".

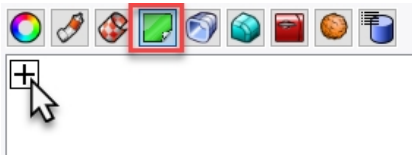

2. Navigate to and select image file, tHbestLogo.png.
3. On the **Decal Mapping Style** dialog, accept the default **Mapping style** of **Planar** and **Direction** of **Forward** by picking **OK**.

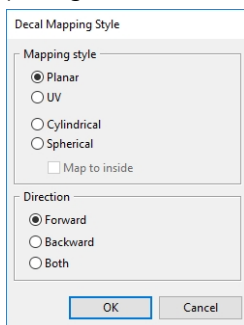

4. In the **Front** viewport, pick two diagonal points to locate and size the decal. This is easier with osnaps disabled.



5. Right-click on the **thbestLogo.png** decal in the **Decal** panel, and pick **Show the Decal Widget**.

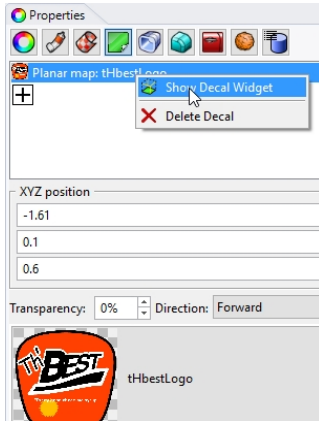

6. On the **Status Bar**, turn on the **Gumball** control. With the Gumball on, you can move, re-size, and rotate the decal with the gumball control.

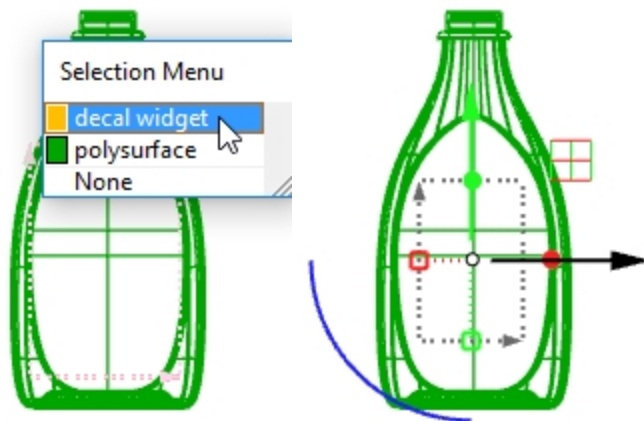

Refer to the **Rhino Help** for additional details on the **Decal** feature.



**On your own**

- Use the **SnapShot** command to save and restore configurations for the bottle and caps. Refer to the **Rhino Help** for details on the **SnapShot** command.

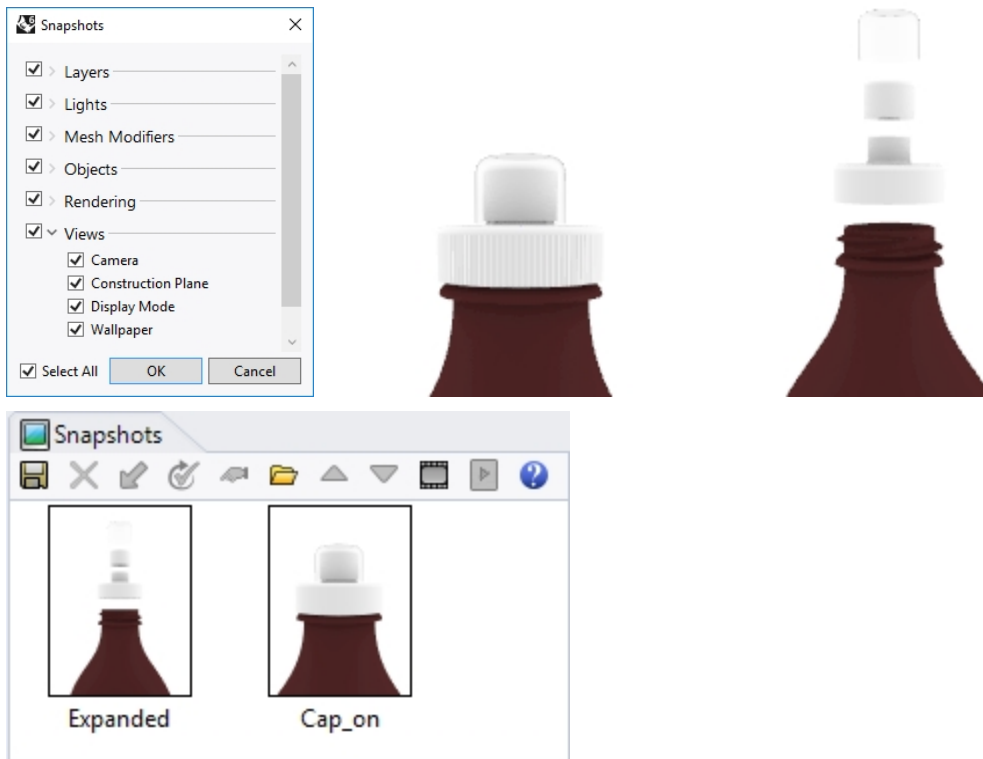

# Chapter 12 - Annotating your model

Rhino can also produce 2-D drawings of your models. Rhino has these annotation objects:

- Dimensions
- Annotation Text
- Leaders
- Dots
- Hatching

## Dimensions

You can create dimensions on all viewports. They will be created parallel to the current viewport's construction plane. Dimension commands are combined with object snaps to give precise values. There are many different types of dimensions that are used to annotate a model. We will look at linear, radial, diameter, and angular.

The **annotation style** controls the way a dimension and the text displays. For example the dimension text location can be above the dimension line or in the dimension line. The end of a dimension line can display an arrow, a tick, or a dot. The dimension text can show decimal, fractional, or feet and inches numbers. A new model will open with Default as the annotation style.

You can make additional annotation styles, assign existing dimensions to a different style, or update a style to make all the dimensions assigned to that style update. You can also import a annotation style from another model. Or add the annotation style to a template so new models always have it.

Let's look at the dimension types:

## Dimension types

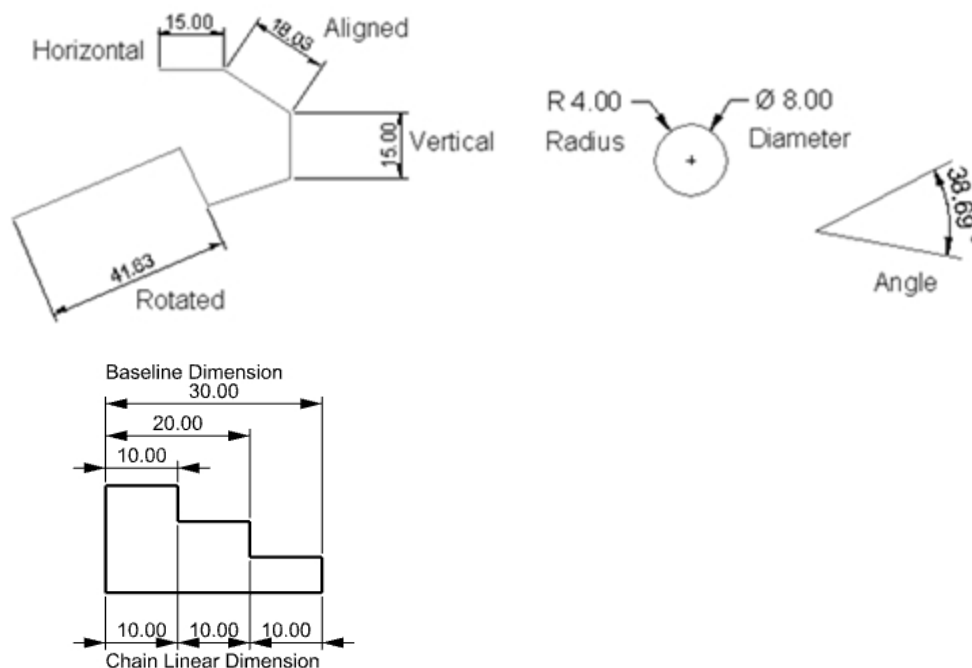

## Annotating the model

Annotation styles control the appearance of both annotation text and dimension objects. These are saved with your model.

Changes to the properties of an annotation style will update all the text and dimensions that are assigned to that style. It is possible to override the properties of the annotation style on a per object basis. These objects with overrides will not update with changes to their assigned style.

You may also have your favorite styles already created in a template file. These styles will be ready to go in your new files.

To start this exercise you will create a new annotation style. Then, you will create text and dimensions that will use your new annotation style.

## Exercise 12-1 Dimension the part

### Make a new annotation style

1. Open the model **Dimension.3dm**.
2. On the **Tools** menu, click **Options**.
3. In the **Rhino Options** dialog, under **Document Properties**, pick **Annotation Styles**.
4. Next to **Annotation Styles**, click the chevron > to expand the list of existing styles.
5. On the right margin of the **Annotation Styles** page, click **New** button.
6. In the **New Annotation Style** dialog, select **(built-in) Millimeter Small** as the new annotation style template. Pick OK.

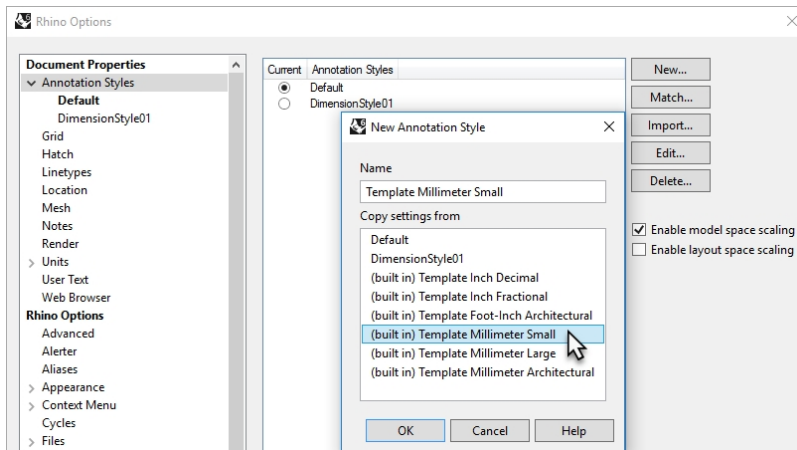

7. Highlight the radio button next the new style **Template Millimeters Small** to make it the current annotation style.  
As the current style, any new text and dimensions objects will be assigned to the **Template Millimeters Small** annotation style.

### Edit the new annotation style

1. Select **Template Millimeters Small** as the current annotation style, then click the **Edit** button on the right of the **Annotation Style** dialog.
2. At the top of the **Edit** page, change the **Style name** to **Millimeter Small**.
3. Next change **Model space scale** to **1.0**



- Under the **Arrows** section, reset the **Arrowhead 1** and **Arrowhead 2** from **Open Arrow** to **Arrow**.  
**Note:** Browse the dialog and familiarize yourself with the many annotation style settings. As you change a setting, the preview images at the top of the **Annotation** style page will update.

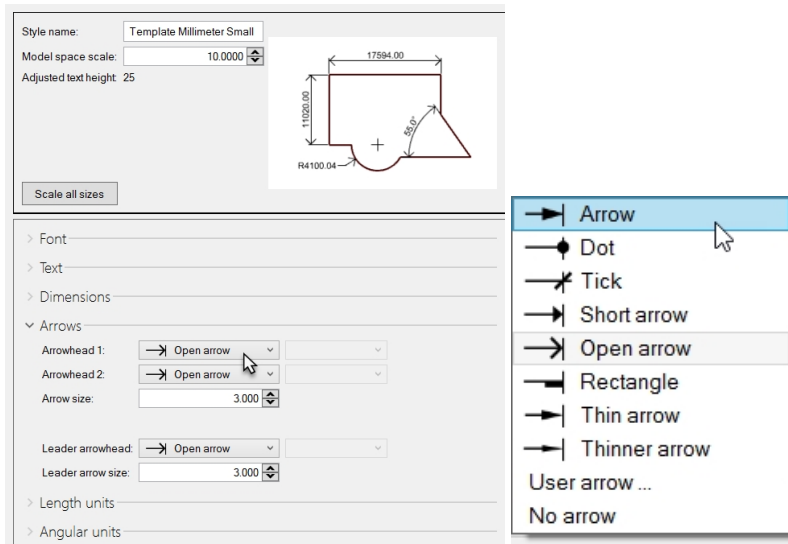

- Click **OK** to save your edits.  
 New dimensions and text will be assigned to the **Millimeter Small** dimension style.  
 Or an existing dimension can be changed to this style on the **Dimension** page of the **Properties** panel.

## Linear Dimensions

Linear dimension creates a horizontal or a vertical dimension.

### Make linear dimensions

- On the **Dimension** menu, click **Linear Dimension**.
- In **Top** viewport, snap to the lower left end of the part.
- In the **Top** viewport, snap to the lower right end of the part.
- In the **Top** viewport, pick a point below the part.

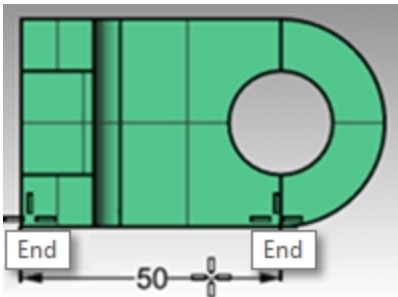

- On the **Dimension** menu, click **Linear Dimension**.
- In **Front** viewport, snap to the lower left end of the part.
- In **Front** viewport, snap to the upper left end of the part.
- In **Front** viewport, pick a point to the left of the part.

- In the **Front** viewport, create two additional linear dimensions on the top and right sides of the part.  
**Note:** Use object snaps to locate the extension line origins. To move extension line or text locations for dimensions, turn on control points for the dimension and move the control points.

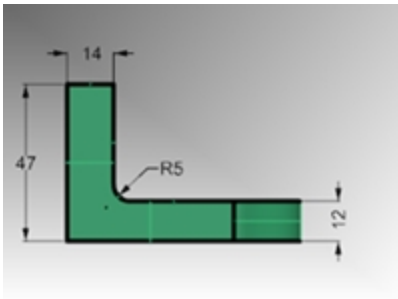

## Leaders

Leaders include an arrowhead and text.

### Draw an arrow leader and text

- On the **Dimension** menu, click **Leader**.
- In the **Front** viewport, click the top of the part.  
This will be where the arrow will be created
- Turn **Grid Snap** on and click a point to the right and at an angle from the first point.  
Or use the **Shift** to temporarily enable the ortho during the pick.
- Click to the right of the second point, and press **Enter**.

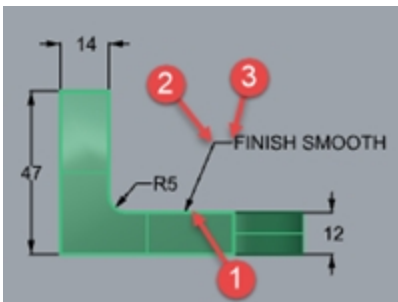

- In the **Leader Text** dialog box, type **Smooth Finish**, and click **OK**.

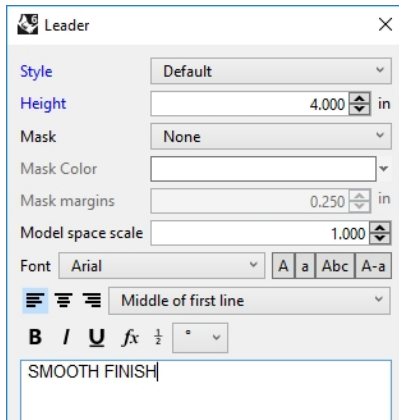

- To edit the text, double-click and make changes in text box.
- Click in graphics area when editing is complete.
- For long notes try the word-wrap feature on the leader object.  
Use the **PointsOn** command to turn on the control on the Leader text.

- Select the Control point on the right.

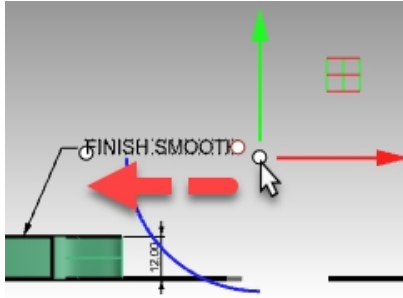

- Using the gumball, drag the point to the left, and re-size the width and, wrapping the text.

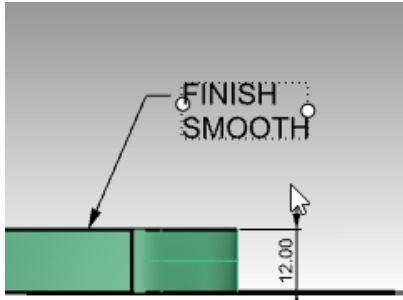

- Esc** to turn off the control points on the leader text.

## Radial and Diameter Dimensions

Radial and diameter dimensions note arcs and circles.

### Make a radius or diameter dimension

- On the **Dimension** menu, click **Radial Dimension**.
- In the **Top** viewport, select the lower right quadrant of the arc .
- Click to place the dimension text.

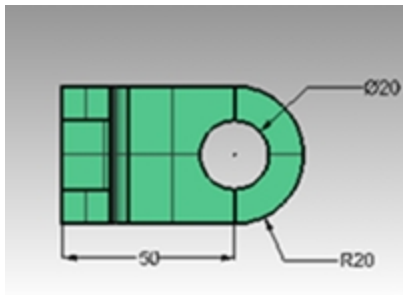

- On the **Dimension** menu, click **Diameter Dimension**.

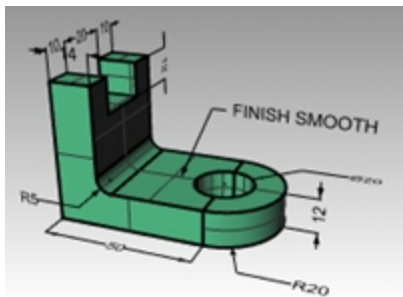

- In the **Top** viewport, select the upper right quadrant of the hole.
- Click to place the dimension text.

## Continuous Linear Dimensions

The **Dim** command has a Continue option, that when activated adds chained dimensions along the same dimension line. This option needs to be activated for each **Dim** command that you begin.

### Make continuous (chained) dimensions

1. On the **Dimension** menu, click **Linear Dimension**.
2. In the Command line, set **Continue=Yes**.
3. In **Top** viewport, snap to the left end of the part (1).
4. In the **Top** viewport, snap to the end of the vertical part (2).
5. In the **Top** viewport, pick the **Dimension line location** (3).
6. Continue to snap to the center of the hole (4), and the right end of the object (5).
7. Press **Enter** to end continuous linear dimension.

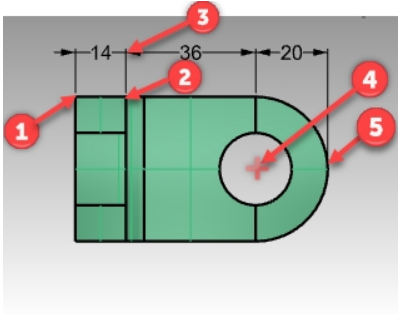

8. In the **Top** and **Right** viewports, create additional continuous linear dimensions on the side and on the bottom of the part.

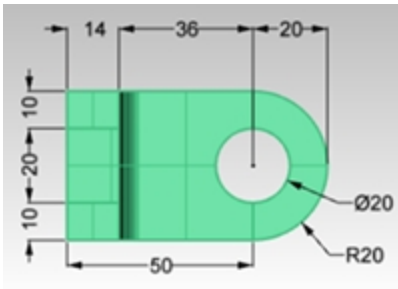

9. Now dimension the rest of the drawing using leaders, text blocks, horizontal, vertical, radius, and diameter dimensions.
10. **Save** your model.

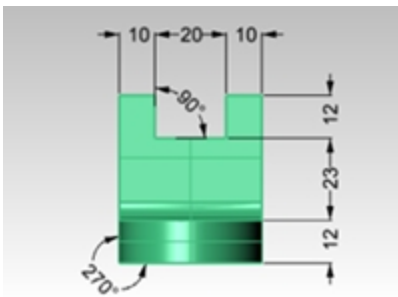

### Baseline Linear Dimensions

The **Dim** command has a baseline option to create a string of dimensions that all measure back to the initial start of the first dimension in the string. Because you have just made a set of chain dimension, the dimension will try to continue from that previous dimension. You will need to make one dimension first, and then continue with baseline. Here are the steps.

#### Make baseline dimensions

1. On the **Dimension** menu, click **Linear Dimension**.
2. The dimension is continuing from the last dimension. In Command line, set **Continue=No**.
3. In **Top** viewport, snap to the left end of the part (1).
4. In the **Top** viewport, snap to the end of the vertical part (2).
5. In the **Top** viewport, pick the **Dimension line location** (3).

6. Press **Enter** to repeat the **Dim** command.
7. In Command line, set **Continue=No** and **Baseline =Yes**.
8. Continue to snap to the center of the hole (4), and the right end of the object (5).
9. Press **Enter** to end baseline linear dimension.

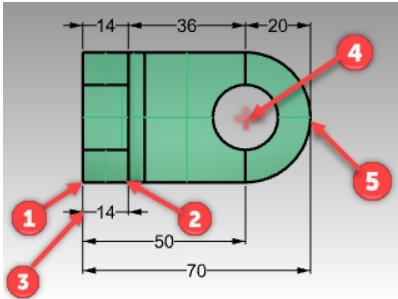

### Continuing a dimension

1. On the **DIMENSION** menu, click **Linear Dimension**.
2. In Command line, set **Continue=Yes**. A dimension may be continuing from the last dimension.
3. In Command line, click **SelectDimensionToContinue**.
4. At the **Select dimension to continue** pick the existing dimension that you would like to continue (1).
5. Continue to pick end points for new dimension (2).
6. Press **Enter** to end linear dimension.

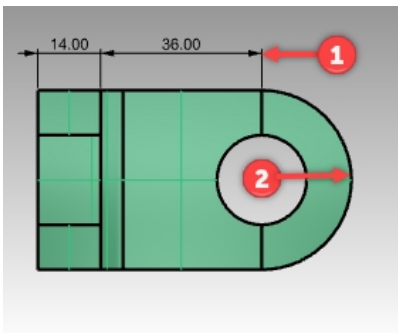

## Making a 2-D drawing from a 3-D model

Rhino has the ability to generate a two-dimensional drawing from a three-dimensional model, by projecting the geometry to the world coordinate plane, and aligning the views. Options for first angle projection or third angle projection are available. In addition to the three orthographic views, a two-dimensional perspective drawing is also generated. Hidden lines are removed and placed on a separate layer.

Options for creating four views (three parallel projection viewports and one perspective projection viewport), or single views of individual viewports are supported.

### Exercise 12-2 Practice making a 2-D drawing

1. Open the model **Make2D.3dm**.
2. Select the 3-D model.
3. On the **DIMENSION** menu, click **Make 2-D Drawing**.
4. In the **2-D Drawing Options** dialog box under **Projection** click **Third Angle Projection**. Under **Options** check **Tangent edges** and check **Hidden Lines** then click **OK**.

The 2-D drawings are created on the **Top** construction plane near the origin on the world xy plane. View them in the **Top** viewport.

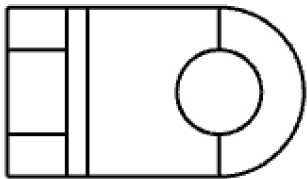
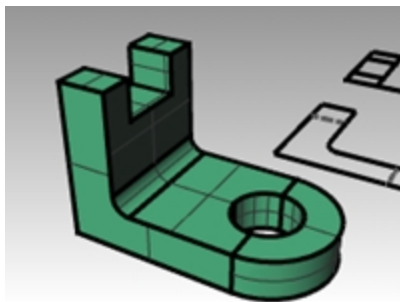
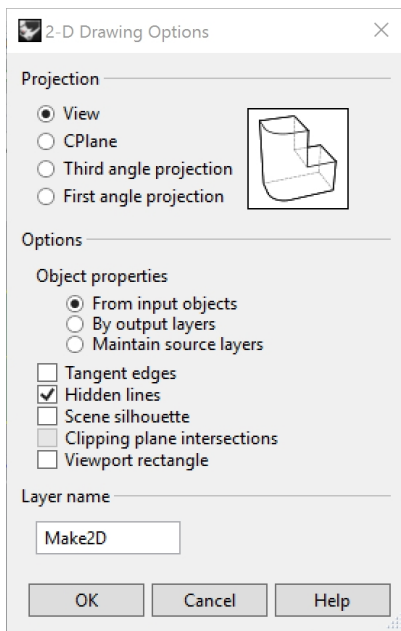

↻

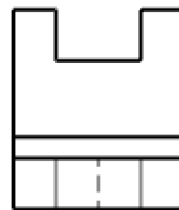
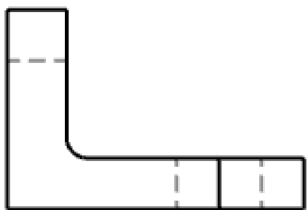
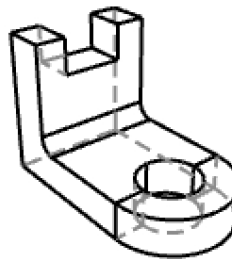

## 5. Dimension the 2-D drawing.

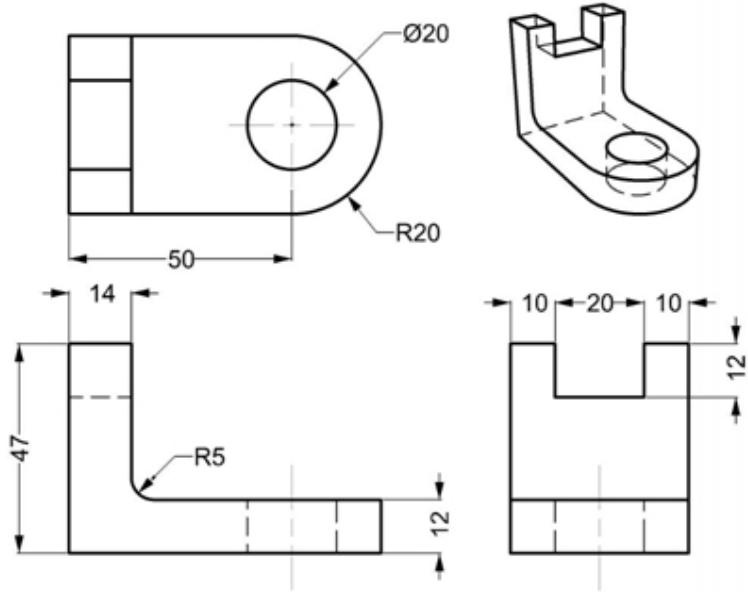





# Chapter 13 - Importing and exporting

Rhino supports many different import and export formats, making it possible to model in Rhino and then export your model to downstream processes, or import models from other software applications into Rhino. For a complete list of import and export file types refer to the Rhino Help > Contents > File I/O > File Formats.

## Importing other file formats into Rhino

We will not be importing any models in this class. Importing files from other applications is covered in our Level 2 Training course. If you have any specific questions about importing models into Rhino, consult your instructor.

## Exporting Rhino File Information

When you export to a format like 3DS, STL or DWG, Rhino has to convert from smooth NURBS surfaces to a polygon mesh representation made of triangles. To do a good approximation of the curved surfaces, Rhino can sometimes use many polygons. The density of triangles can be adjusted when exporting. You can create a mesh object and export it, or Rhino can create the mesh during the export process.

There are two methods to export models to other formats. You can use the **Save As** command to choose a specific export format to export an entire model. Or, you can select some objects and use the **Export Selected** command to choose a specific export format to export a portion of the model. In the following exercise you will use the **Save As** method to export three of the most common file formats.

## Exercise 13-1 Export a model to a mesh format

1. **Open** the model **Export.3dm**.
2. On the **File** menu, click **Save As**.
3. In the **Save** dialog box, change the **Save as type** to **Stereo lithography (\*.stl)**.
4. In the file name box type **Export** and click **Save**.

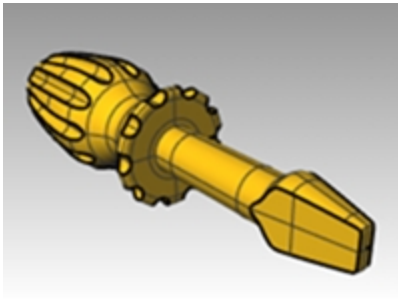

5. In the **STL Mesh Export Options** dialog box, set the **Tolerance** to **0.01**, and click **Preview**.

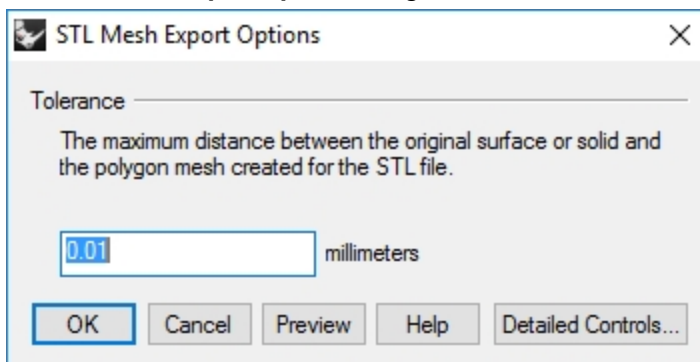

6. Set the **Tolerance** to **0.1**, click **Preview**, and then click **OK**.
7. Visually inspect the preview. If the mesh faces do not follow your geometry, increase the tolerance to .001 and preview again.

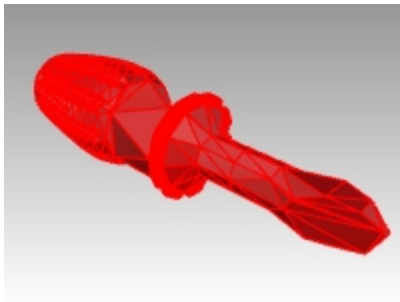

Poor Preview

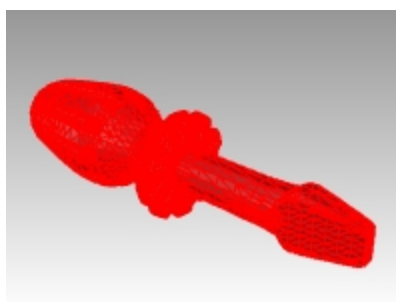

Acceptable Preview

- In the **STL Export Options** dialog box, select **Binary**, uncheck **Export open objects**, and click **OK**.  
**Note:** In most cases, when outputting an STL for 3D printing, the "Export open objects" is NOT checked. You can also isolate your open polysurfaces in Rhino with the **SelOpenPolysrf** and **SelClosedPolysrf** commands.

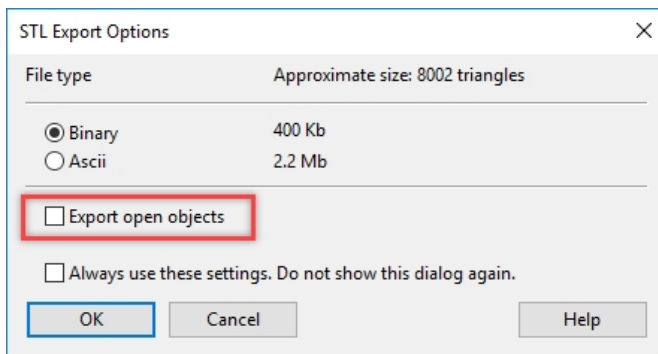

### Export a model to IGES

- On the **File** menu, click **Save As**.
- In the **Save** dialog box, change the **Save as type** to **IGES (\*.igs)**.
- In the **IGES Export Options** dialog box, select **Pro E Windows solids** as the **IGES type**, click **Detailed Controls**. Detailed controls allow the user more input.
- Click **Cancel** to terminate, or **OK** to create the IGES file.

### Export a model to STEP

- On the **File** menu, click **Save As**.
- In the **Save** dialog box, change the **Save as type** to **STEP (\*.stp, \*.step)**.
- In the **STEP Options** dialog box, use the default setting.

# Chapter 14 - Rendering

---

Rhino has a built-in rendering engine called Rhino render. The rendering shows your model as if it were in a photograph or sketch. Rendering your model to look like a photo is called photorealistic rendering. [Flamingo nXt](#) is an example of a photorealistic render plug-in for Rhino. If you render your model to look hand-sketched, this is called non-photorealistic. [Penguin](#) is an example of this type of render. 3rd party renders with more advanced features are available as plug-ins for Rhino.

The built-in Rhino render may all you need for much of your work. In this section, you will work with the features of the built-in Rhino render. Later, you can explore other rendering programs such as Flamingo nXt, V-Ray, Maxwell or others plug-ins for higher quality results. Most 3rd party plug-ins for Rhino are found on the [Food4Rhino](#) web site.

## Materials and other features

Rhino's built-in renderer creates materials with color, reflectivity, transparency, clarity and bump map settings. The render material also allows the attachment of textures for color, transparency, bump and environment.

The renderer has built-in, ready-to-use material presets like Metal, Plastic or Glass. This is very helpful to quickly create new materials with specific preassigned properties.

The renderer offers custom lighting, displays shadows, automatic ground plane, sun and environment. It also has configurable levels of anti-aliasing and post processing options. In this exercise we will focus on the rendering features.

## Exercise 14-1 Practice rendering the toy screw driver

---

1. Open the model **Render.3dm**.
2. On the **Render** menu, click **Current Renderer**, and then click **Rhino Render**.
3. On the **Status Bar**, turn off **Gumball**.
4. Right-click on the **Perspective** title bar, and then click **Rendered** display.



The viewport mimics but does not exactly duplicate what you will get in a Render.

### Setting the Rendering Defaults

It may be necessary to return a model to the rendering defaults or reset a model from an earlier Rhino version to the Rhino 6 defaults.. An fast and convenient way to perform this task is to use the **Reset to Defaults** button on the **Rendering** panel.

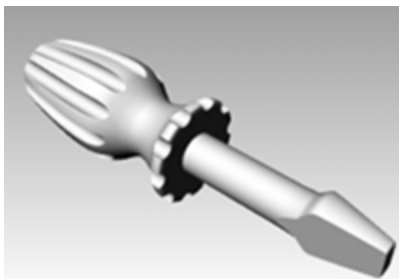

1. Right click on the tab of any open panel, and pick the **Rendering** panel.

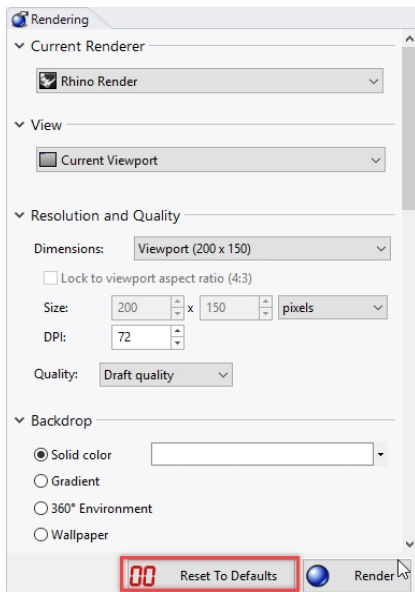



2. At the bottom of the **Rendering** panel, pick on the **Reset to Defaults** button.



3. The Rhino render settings and environment will be set to the Rhino 6 rendering defaults and ground plane. This is helpful when opening a model created by an earlier version of Rhino. In these older model, the rendering will look very gray compared to the Rhino 6 templates. Picking the **Reset to Defaults** is an easy way set the model to the Rhino 6 rendering defaults.

### Assign a material to the handle by object

To render the handle in color, we will first assign a red glossy material to the handle object. This material assigned to the object will override any material that might be assigned to the layer of the object.

1. Select the handle.
2. In the **Properties** panel, click the **Material**  button.
3. On the **Material** page, pick drop down arrow  on **Use Layer Materials** menu, choose  **Use a new material**.
4. On the **Material** template list, pick **Plastic**.
5. In the name field, type **Red\_glossy**.
6. Click the **Color** swatch.

7. In the **Select Color** dialog box, select **Red**, and click **OK**.

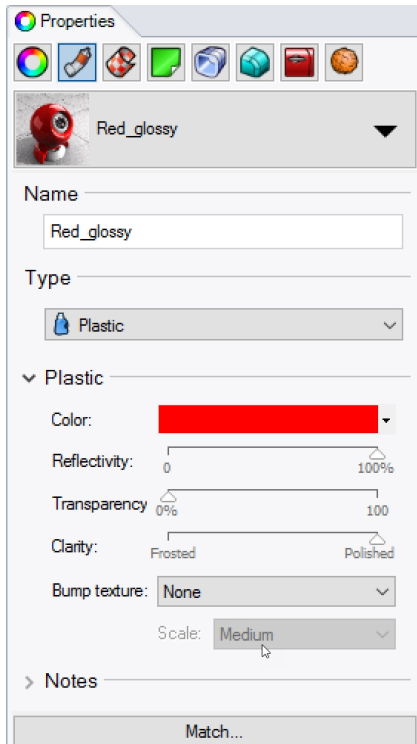

When the **Perspective** viewport is in **Render** display mode, you can preview the material color in the viewport.

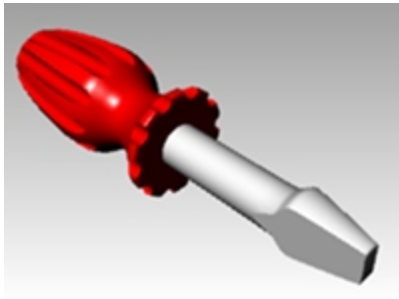

8. On the **Render** menu, click **Render**.  
A display window appears with the current viewport rendered in colors, but it will probably lack detail. You can close the Display Window without disturbing your model. Placing lights will add depth and detail to the rendered image.

The image size is determined by the **Resolution and Quality Setting** on the *Options > Document Properties*,

*Render* page. By setting the **Dimension** option to Viewport, Rhino will render to the current viewport resolution. Vary the render size by maximizing and re-sizing the viewport being rendered.

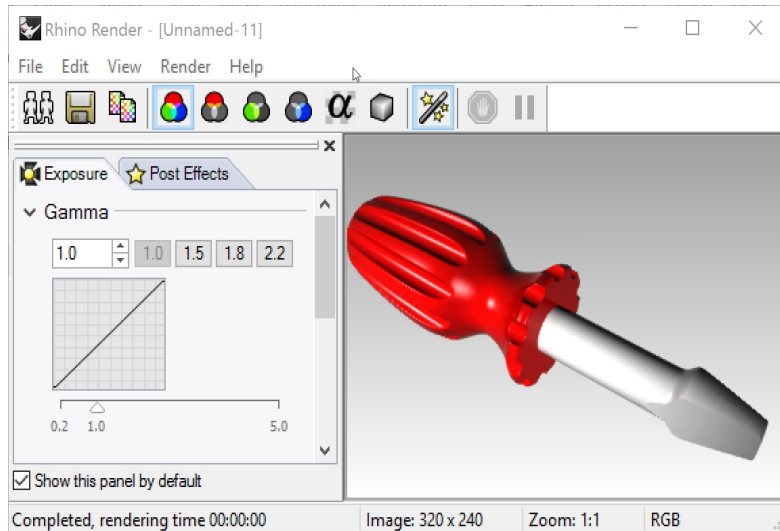

### Assign a material to the blade by layer

To render the blade in color, we will assign a glossy, yellow plastic material to the **blade** layer. All the objects on the **blade** layer that are set to **Use Layer Material**, will be rendered in the layer's assigned material. Changing the layer's material will update all the objects on the layer that are set to set to **Use Layer Material**. This is the advantage of rendering with material set to **Use Layer Material**.

1. Select the blade.

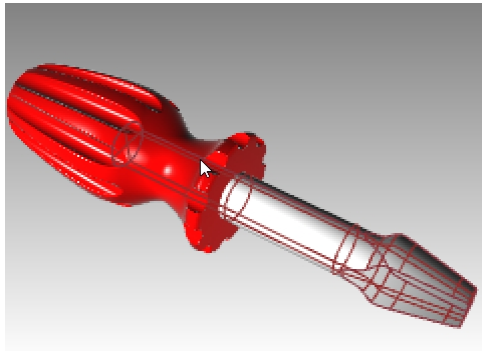

2. If the **Properties** panel is not open, right-click on the tab of any open panel, and click **Properties**.
3. In the **Properties** panel, on the **Material** page, verify that the material is set to **Use Layer Material**.
4. In the **Layers** panel, click the **Material** icon for the **Blade** layer.

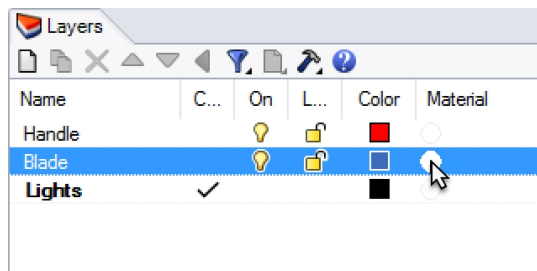

5. In the **Layer Material** dialog in the **Name** box, type the name **Yellow\_glossy**.
6. Under **Type**, select **Custom**.
7. Under **Custom Settings**, click the **Color** swatch.
8. In the **Select Color** dialog box, select a color, for example, **Yellow**, and click **OK**.
9. Set the **Gloss finish** between **80 and 90%**

10. Set the **Reflectivity** slider to **5%**

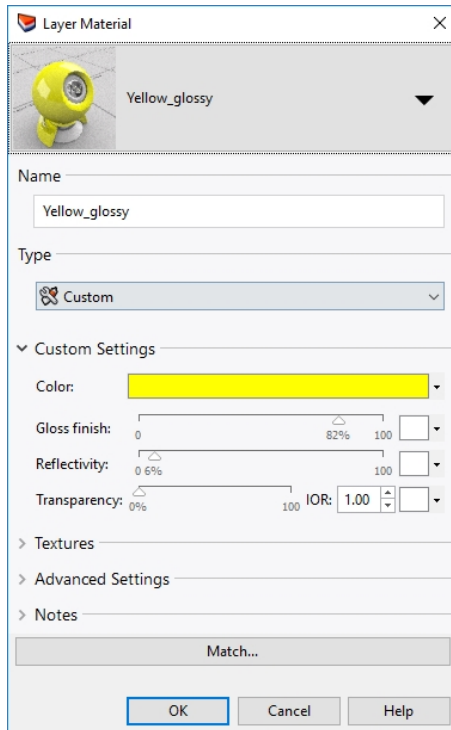

11. On the **Render** menu, click **Render**.

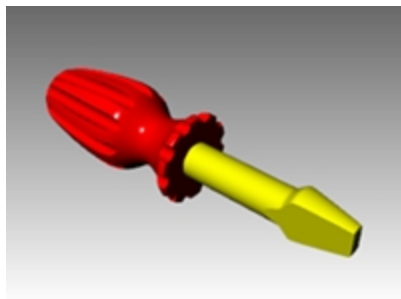
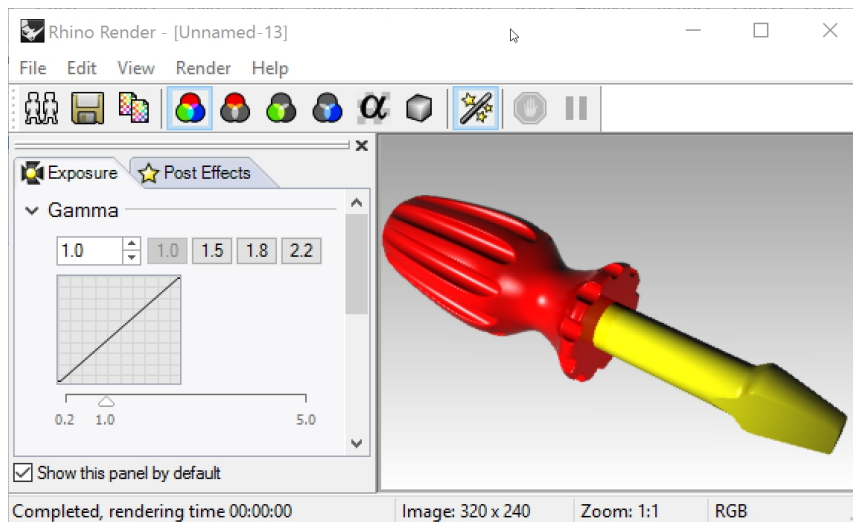

### Add a new preset material to a layer

1. In the **Layers** panel, click the **Material** icon for the *Blade* layer.
2. In the **Layer Material** dialog box, click the drop down arrow next to the **Yellow\_Glossy** material.

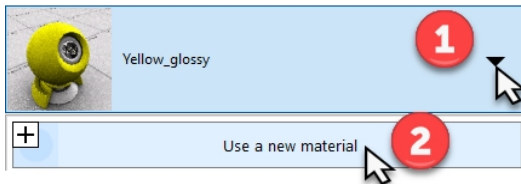

3. When the list of materials appears, click **Use a new material** and click the type **Plastic**.

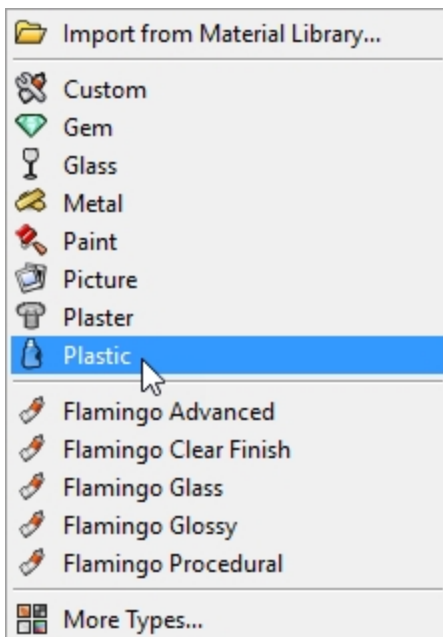

4. In the **Name** box type **White\_Plastic**. Pick the color swatch and set the color to **white**
5. **Render** the model.
6. The next time you click the down arrow for a material listed in the **Layer Material** dialog, you will see a list including **Default Material** and the three materials you just created.  
You can switch between any of the materials in the model or make a new one at any time. This works whether you are assigning the material by layer or object.

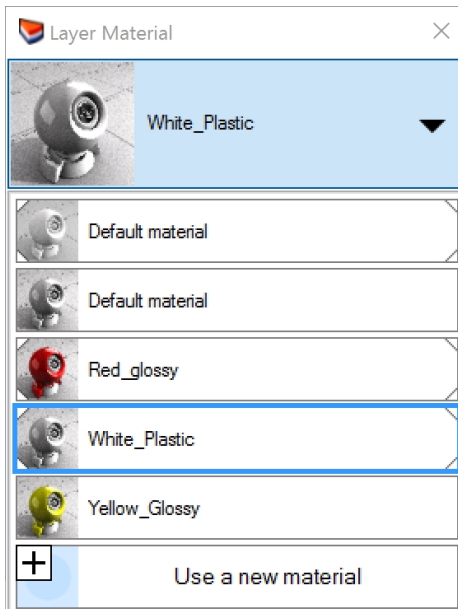



## Add lights

Start with a standard lighting scheme. You can experiment to develop your own lighting schemes later.

### Place a light

1. **Zoom out** in the **Top** and the **Front** viewport.
2. Make the **Lights** layer current.
3. On the **Render** menu, click **Create Spotlight**.
4. For the **Base of cone**, type **0** and press **Enter**.
5. For the **Radius**, in the **Top** viewport, pick a point so that the circle is larger than the entire screwdriver.

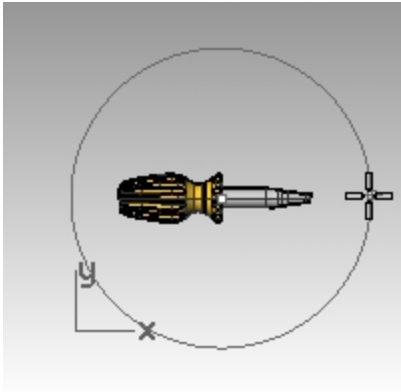

6. For the **End of cone**, hold down the **Ctrl** key, and in the **Top** viewport, pick a point below and to the right. This starts elevator mode.

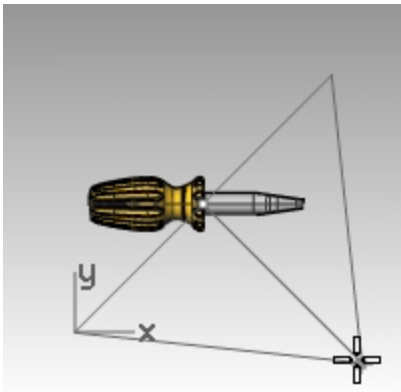

7. For the **End of cone**, in the **Front** viewport, pick a point above the object. This will be your main light.
8. Make the **Perspective** viewport active.
9. On the **Render** menu, click **Render**.  
The image now has some highlights and shadows. The automatic ground plane is also visible.

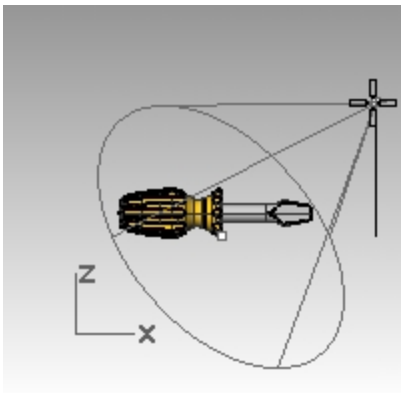

## Place a second light

1. **Zoom out** in the **Top** and the **Front** viewport.
2. On the **Render** menu, click **Create Spotlight**.
3. For the **Base of cone**, type **-70,0** and press **Enter**.
4. For the **Radius**, in the **Top** viewport, pick a point so that the circle is larger than the handle of the screwdriver.

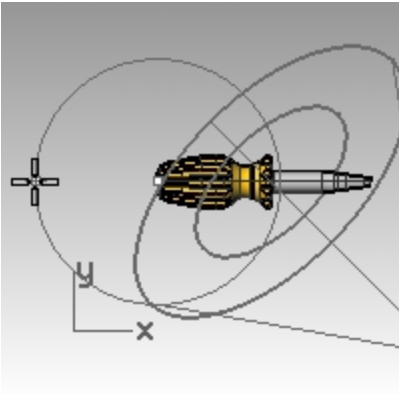

5. For the **End of cone**, hold down the **Ctrl** key, and in the **Top** viewport, pick a point below and to the left. This starts elevator mode.

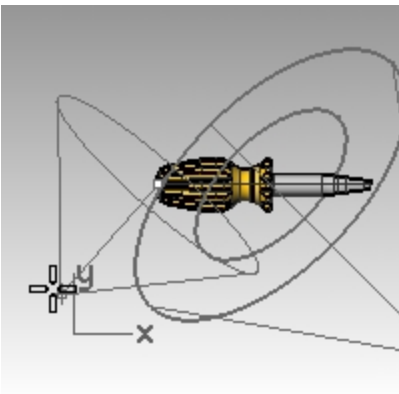

6. For the **End of cone**, in the **Front** viewport, pick a point above the object. This will be your secondary (fill) light.

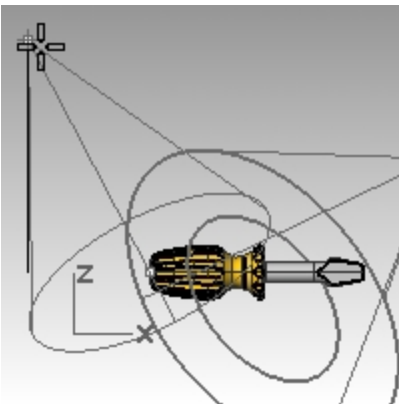

7. Make the **Perspective** viewport active, and set its display mode to **Rendered**.



8. On the **Render** menu, click **Render**.



### Assign properties to the lights

1. Select the new light.
2. In the **Properties** panel, click the **Light** icon.
3. On the **Light** page, turn the second light **Off**.
4. Select the first light
5. In the **Properties** panel, click the **Light** icon.
6. On the **Light** page, change the **Intensity** to **90** the **Shadow intensity** to **50** and the **Spotlight hardness** to **50**. Experiment with these settings to get the desired effect.
7. From **Options** and **Render** settings, scroll to Lighting section. Lower the Skylight **Intensity** option to **.5**.
8. Make the **Perspective** viewport active.



9. On the **Render** menu, click **Render**.



10. Finally, in the **Layer** panel, make the **Default** layer current and turn the **Lights** layer **Off**. The Skylight and the default environment will provide the lighting.
11. On the **Render** menu, click **Render**.



## Add textures

### Add a bumpy surface to the handle

---

1. Select the handle.

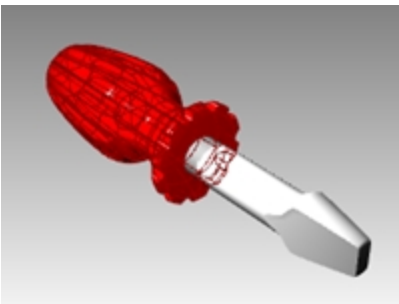

2. In the **Properties** panel, click the **Material** button.

- On the **Material** page, under **Bump texture** setting, click the drop down arrow next to **None** to assign.

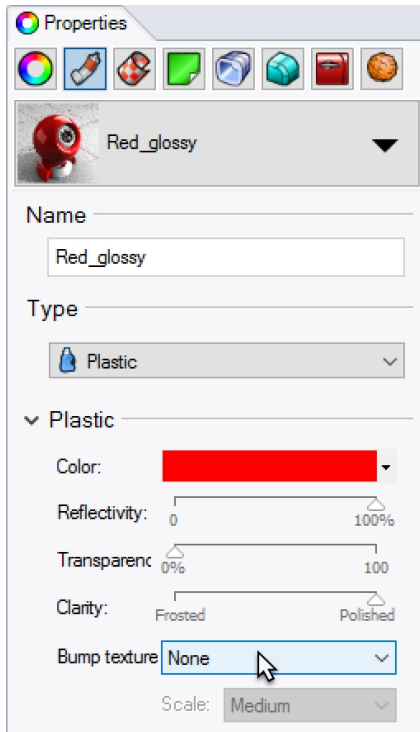



- From the list of built-in Bump textures, select **Leather** and set the Scale to **Medium** or **Small**.
- The Rendered display will update to display the bump.  
The surface of the handle has a bumpy appearance, however the color of the material and gloss setting is still used.



The bumps come from the pattern of light and dark in the bitmap image. You can use a bitmap file for a bump.

#### Add a custom material to the handle

- Select the handle .
- In the **Properties** panel , click the **Material** page button.
- Choose the arrow  to expand menu and pick  next to **Use a new material**.
- In the pop-up dialog, scroll to select **Custom** material.
- On the **Material** page, in the name field, enter **Red Marble**.
- In the **Custom Settings** section under **Color**, click the color frame.

- From the **Select Color** dialog, click on a red color or enter **RGB: R=255, G=0, B=0**.

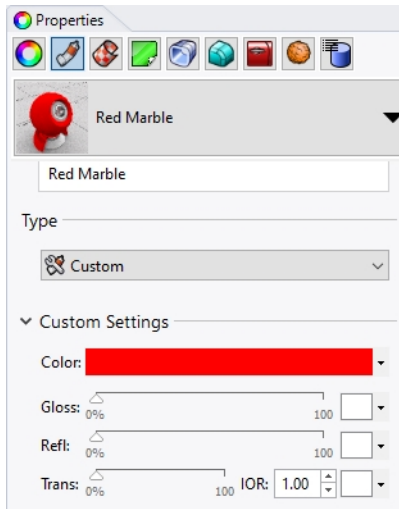

- Under **Bump**, select **click to assign material**.

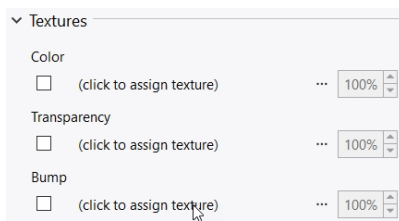

- In the **Open** dialog, pick the button **Choose from more texture types**.

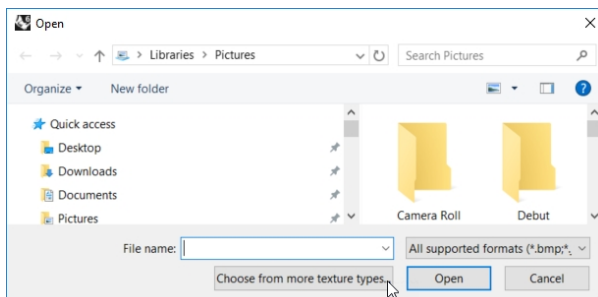

- Under **Type**, click on **Marble Texture** and click **OK**.

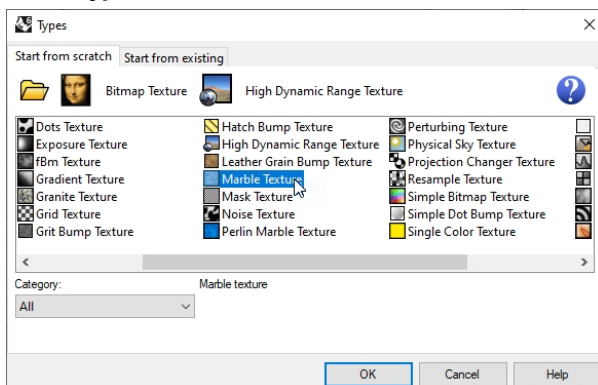

- In the **Edit Marble Texture** dialog, under the **Mapping** section, check **WCS** to enable **World Coordinate System** texture mapping control. Also under **Mapping**, set the size of the tecture to **X Size** to **20.0**, the **Y Size** to **20.0**,

and the **Z Size** to **20.0** click **OK**.

**Note:** The lock bar to the left of these setting, will lock the x, y, and z values to the same setting.



12. The Rendered display will update to display the bump.

The surface of the handle has a bumpy appearance, however the bump texture in the Marble material will not be used by preview. You will need to execute the **Render** command.



13. To see the marble material, on the **Render** menu, click **Render**.



14. On the **File** menu in the **Render** dialog, click **Save As**.

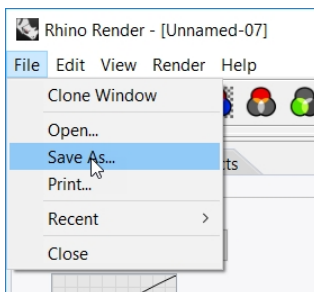

15. Under **Save as type**, click **PNG**. Type your file name and location.
16. Click **Save** button.

## Add a custom texture to the handle

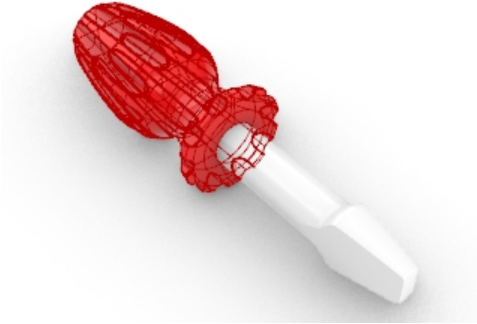

1. Select the handle.

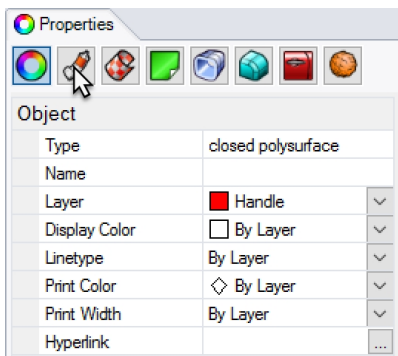

2. In the **Properties** panel, click the **Material** page  button.



3. On the **Material** page, pick drop down arrow  to the right of **Red Marble**.

4. The arrow  will expand menu. Pick  next to **Use a new material**.

5. Under **Type** select **Custom**.

**Note:** The **Custom** template is important because the **Picture** template does not allow for UV repeat.

6. In the **Name** field, type **Wood**.

7. In the **Texture** section, under **Color**, pick "click to assign texture" label.

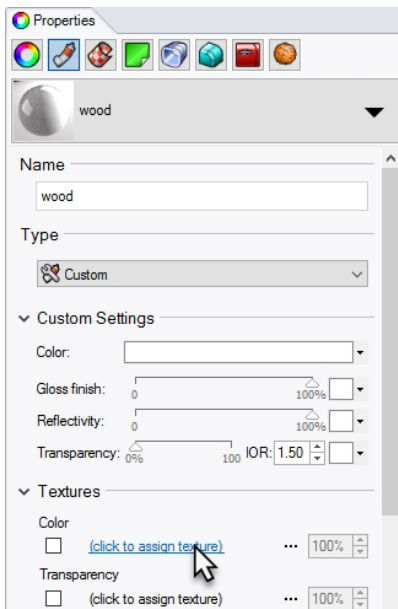



- In the **Open Bitmap** dialog box, select **Wood.jpg**, and then click **Open**.  
Wood color texture is mapped to handle.  
**Note:** This texture file Wood.jpg is included in the Level 1 file set.



- Render. It looks like wood but the texture is being stretched over the entire surface.

### Repeat the texture

- Select the handle.
- In the **Properties** panel, click the **Material** page button.

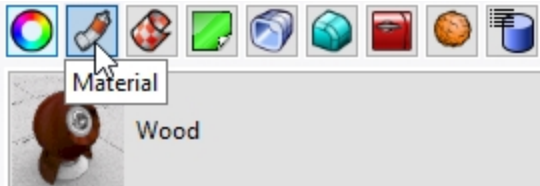

- In the **Textures** section, click on **Wood.jpg** to open the **Editing Wood** dialog.
- In the **Editing Wood** dialog, under **Type** pick **Bitmap Texture**.  
(Simple Texture does not allow for UV repeat.)
- In **Mapping** section, set the **U Repeat** to **4** and the **V Repeat** to **6**.  
Click the lock icon to allow the 4 & 6 input. Select the icon to unlock the uniform repeat.

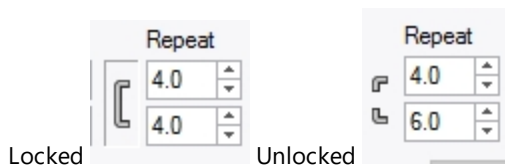

- Click **OK** to close the **Editing Wood** dialog.
- In the **Custom Settings** section of the **Material** page, change the **Gloss** slider to **30%** and the **Reflectivity** slider to **2%**.
- On the **Render** menu, click **Render** or use a **Rendered** viewport.  
The surface of the handle has a wood texture appearance tiled at 4 times in the U and 6 times in the V.



### Make the wood handle transparent

---

1. On the **Panels** menu, click and check the **Materials** panel to turn it on.
  2. Click on the **Wood** material that is already assigned to the handle.
  3. In the **Custom Settings** section of the **Materials** panel, drag the **Transparency** slider to **20%**.
  4. Click back into the graphics area.
  5. On the **Render** menu, click **Render**.
- The handle will look transparent with the Wood texture.



### Make the red handle transparent

---

1. Select the handle.
  2. In the **Properties** panel, click the **Material** page button.
  3. Select **Red\_glossy** from the **Material** list.
- The handle will no longer render in the material assigned to the layer.

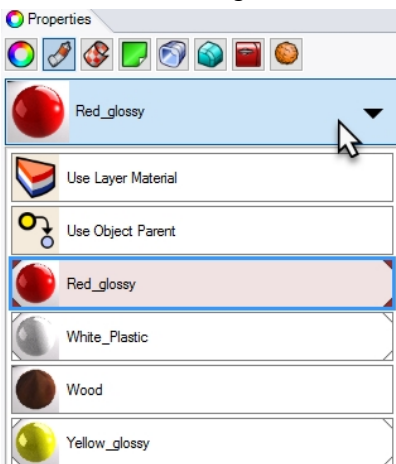

- In the **Object Properties** panel, on the **Material** page and under the **Custom Settings** section, change the **Transparency** slider to **30** and clear the **Bump** texture box to disable the **cell2** texture setting.

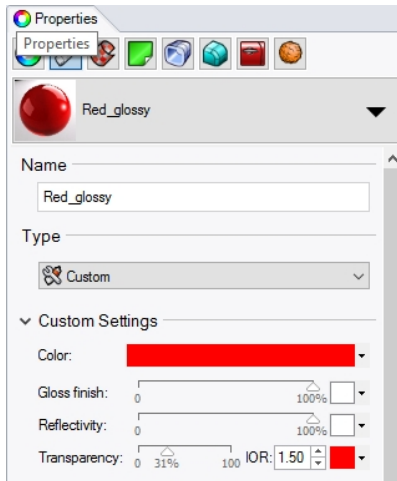

- Click back into the graphics area.
- On the **Render** menu, click **Render**.  
The handle will look transparent with the red glossy material.



- Finally, on the **Material** page, under the **Custom Settings** section, return the **Transparency** slider to **0**.

## Use the ground plane

The Rhino Render has a ground plane option. The ground plane provides an infinite horizontal platform for the image that stretches to the horizon in all directions positioned at a defined elevation. A ground plane renders much faster than using a surface as a background. Any material can be assigned to the ground plane.

### Turn on the ground plane

The ground plane may already be on, but if not you can turn it on in the **Ground Plane** panel.

- Right-click **Properties** panel tab.
- On the menu, click **Ground Plane** panel.
- In **Ground Plane** panel check the **On** box.  
The viewport will display a ground plane.

- Click option **Use a material**.  
The **Default material** is assigned.



- In the **Material** list pick the existing **Yellow\_glossy**, a material created earlier in this exercise. Viewport will now show a yellow glossy ground plane.



- On the **Render** menu, click **Render**.

### Change the ground plane texture

- In **Ground Plane** panel, click the down arrow next to the **Yellow\_Glossy** material.
- When the list of materials appears, click the "+" button next to **Use a new material** material, and select **Picture**.

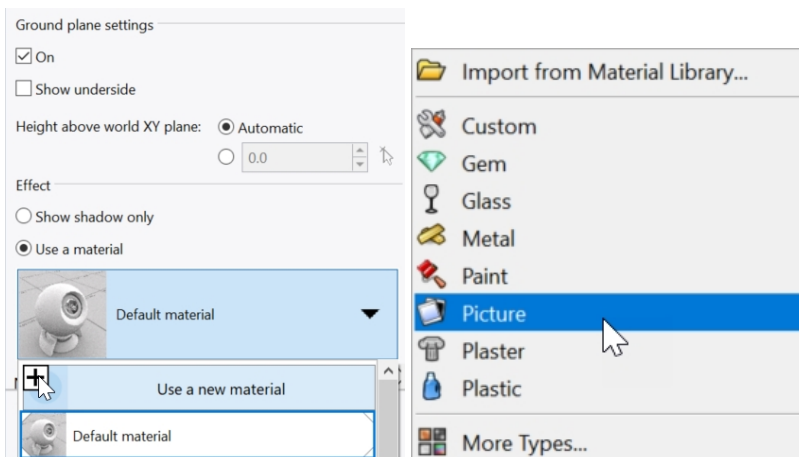

- In the **Open** dialog, navigate to folder where you have the Level 1 training support files, and select **Wood.jpg**. A new custom material will be added.
- Double-click the new Wood material to continue editing it.
- On the **Material** page, in the **Name** field, type the name **Wood\_table**.

6. In the **Texture mapping** section, click on the scale icon to allow for non-uniform scale of the texture.

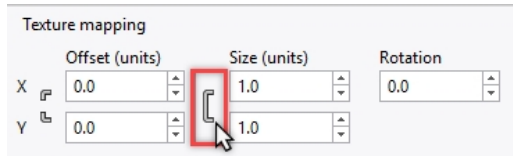

*Scale Texture Uniform*

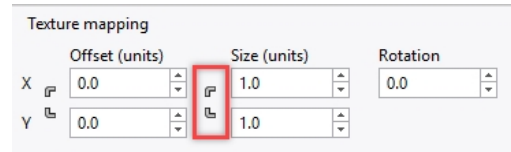

*Scale Texture Non-Uniform*

7. In the **Texture mapping** section, type **X** size **100** and **Y** size **75**.

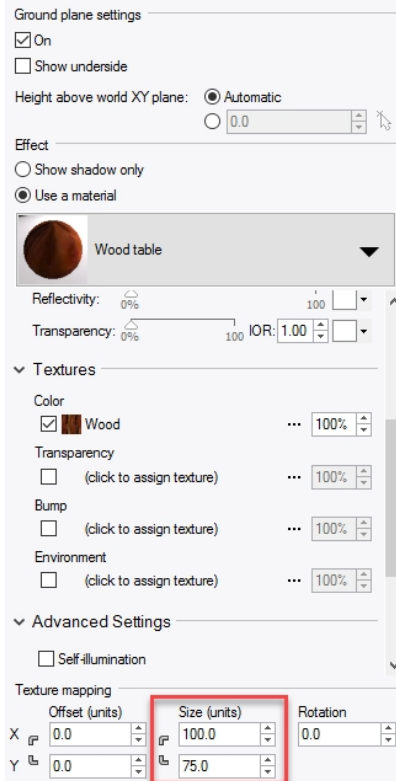

8. The viewport in **Render** mode will now show and render a wood ground plane.



9. On the **Render** menu, click **Render**.
10. On the **File** menu in the **Render** dialog, click **Save As**.
11. In the Save As dialog, in the **Save as type** control, click **PNG**.
12. Type your file name and pick the folder location.
13. Click **Save** button.

## Setting the Rendering Resolution

The **Rendering** panel manages the Rhino Render settings for the current model. You can select your current Render and set Resolution and quality here.

1. Right-click **Properties** panel tab.
2. On the menu, click **Rendering** panel.
3. In the **Current Renderer** area should be set to **Rhino Render**
4. Under **Resolution and Quality** area, pick the **Dimensions** list box, and select **800 by 600**.
5. On the **Render** menu, click **Render**. After viewing, close the Rhino Render dialog.
6. Next, on the **Rendering** panel under **Resolution and Quality**, pick the **Dimensions** list, and select **Viewport resolution**.
7. On the **Render** menu, click **Render**. Compare this option to the fixed size.

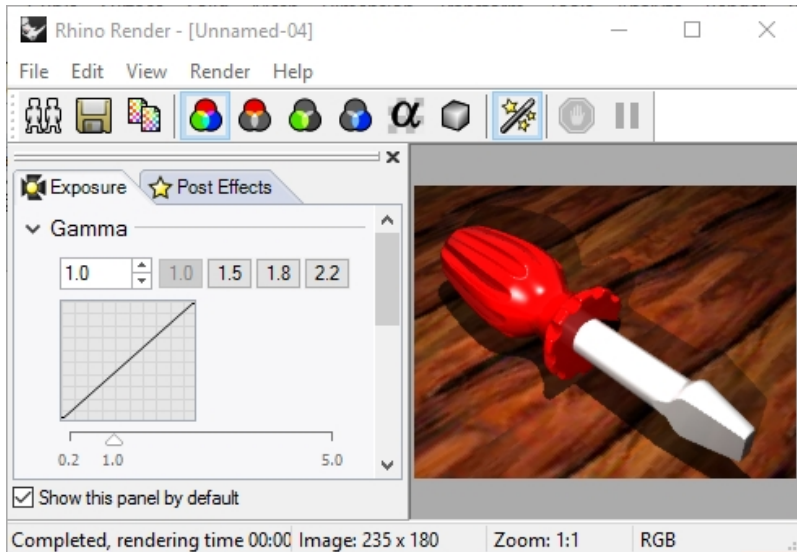

## Rendering Metals

Now you will assign a metal material to the blade.

1. Select the handle.
2. In the **Properties** panel, click the **Material** button.
3. Select **Use Layer Material**
4. In the **Layers** panel, click the **Material** icon for the Blade layer.
5. In the **Layer Material dialog** pick **Use New Material**
6. In the new material **Type** area, select **Metal**.
7. In the **Name** field, type **Metal\_silver**.
8. In the **Metal** section, click on the color frame to select from additional metal color options.

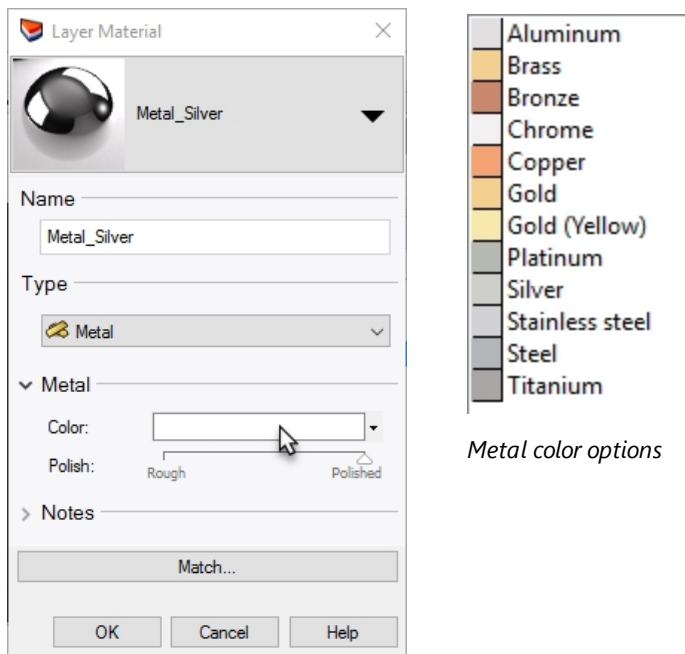

*Metal color options*

9. Click **OK**.
10. From **Render** menu, click **Render**

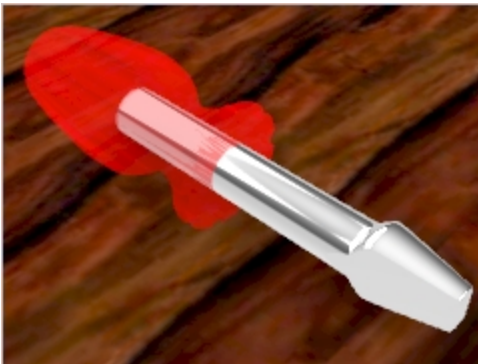

You will see the blade rendering in the silver metal.

## Raytraced Mode

The **Raytraced** display mode sets the viewport to a render mode with **Cycles**, a real-time raytracer. The image will continue to progressively improve indefinitely. The raytrace engine uses the Cuda cores on the Nvidia graphics cards and therefore may not be suitable for all computers.

**Completed** passes are displayed in a status bar at the bottom of the viewport. It indicates how many passes on your image have been completed. 50 passes minimum is typically recommended. You may always leave the viewport and return to complete more passes and improve the raytraced image.

When you decide that the raytraced image is ready to be saved to a file, use the **ScreenCaptureToFile** command. This command will write your rendering to a file in one of the standard image file formats.

4. On the **Perspective** viewport menu, click **Raytraced**

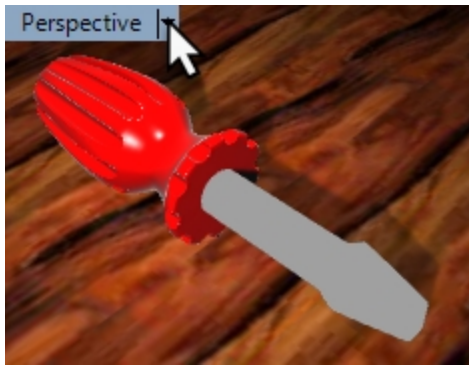

5. The viewport updates with materials and lighting in the real-time, persistent raytraced image of the model.



- 6.

## Rendering with Sun



Rhino also offers a Sun as a lighting option. The sun is a strong directional light whose location and direction is determined by the Sun Position, Date and Time, and Location settings.

### Exercise 14-2 Rendering the Gazebo

Next you will render using the architectural model. You will use the features of Sun, environment, and directional light to get a realistic looking exterior rendering.



## Turn on the ground plane and sun

1. Open the model **Gazebo.3dm**.

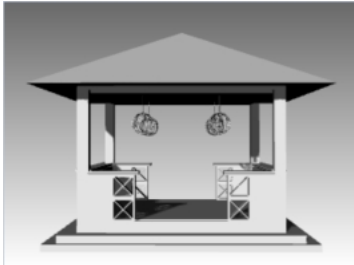

2. On the **Panels** menu, click and check the **Rendering** panel to turn it on.
3. In the **Rendering** panel, pick the **Reset to Defaults** button. In the dialog that appears, pick the **OK** button to confirm the reset of rendering settings to defaults, including turning on the ground plane.

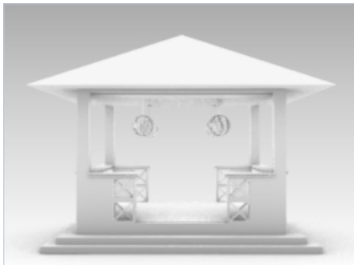

4. Next, right-click **Properties** panel tab and click the **Sun** panel on. This is another way to control the Panel display.
5. In the **Sun** panel check the **On** box. Now the shadows appear.

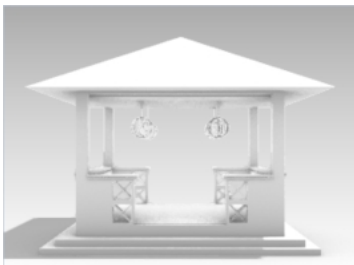

## Configuring the Ground Plane

1. On the **Ground Plane** panel, under the **Effect** area, pick the button next to **Use a material**.
2. In the **Use a material** pick the arrow (1), the plus + (2) and from the menu pick on the **Import from Material Library** (3).

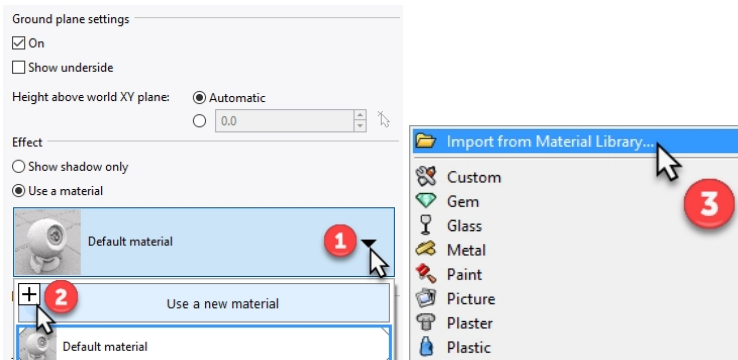

3. Navigate to the folder **Render Content\Organic\Grass** and select the **Grass bright** material.

- In the **Ground Plane** panel, under the **Texture mapping** section, in the **X size field**, type **10**. Since the x & y dimensions are locked, the **Y size field** will change proportionally.

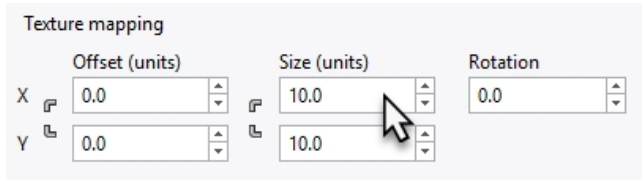

- Pick outside the panel and on the viewport to update the material. The grass material is assigned to the ground plane. A viewport set to **Render** display mode will show this grass material on the ground plane

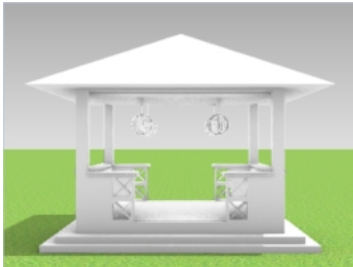

However, with out the sun configured the grass looks dark. Next you will configure the sun to add brightness to your model.

### Setting the Sun position

- In the **Sun** panel, in the **Date and Time** area, pick the month **June** and the time of **3 PM**.

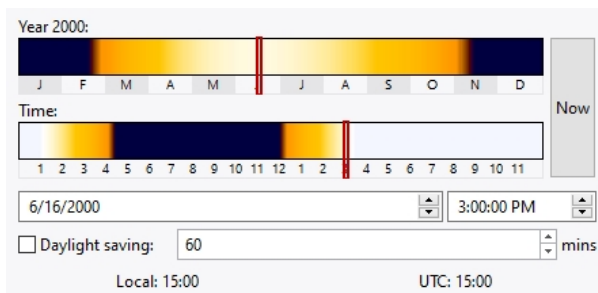

- In the **Location** area, pick **Seattle WA USA**.



- From the **Render** menu, click **Render**.



Next you will assign materials to the layers in the model.

### Assigning Materials

Materials, environments, and textures are stored in the model, but render content can also be saved to files that can be shared between models. Content can be dragged between Rhino sessions and into a folder. The Materials are assigned to objects or to layers. Here you will assign the material to the layer.

1. In the **Layers** panel, turn on the **Planting** and **Fence\_post** layers.
2. In the **Layers** panel, pick on the **Material** icon in each layer row to the layers to configure the materials.



3. Here are some material suggestions.

**Note:** You will find these materials created for you in the file.

Layer	Material	Details
Walls	Rose_Paint	Use Paint template and set color to RGB: 255, 191, 191
Lights	Metal	Use Metal template and select Yellow Gold.
Fence	White_paint	Use Paint template and set color to White.
Roof	Roofing	Import from Library: Render ContentArchtiectural\Roof\Shingle\Cedar brownred
Concrete	Plaster	Use Plaster template and set color to gray: RGB: 190, 190, 190.

## Sizing the Texture Materials

The roof shingle is too small for the gazebo roof. You will edit the size of the bitmap to help the material look more realistic.

1. On the **Panels** menu, click and check the **Materials** panel to turn it on.
2. On the **Materials** panel, click on the **Roofing** material.
3. Scroll to the **Texture** section. Under **Color**, select **Roofing.jpg**.
4. In the **Editing Cedar brownred\_1000\_DB** dialog, under **Mapping**, in the **X size field**, type **4**. Since the x & y dimensions are locked, the **Y size field** will change proportionally.

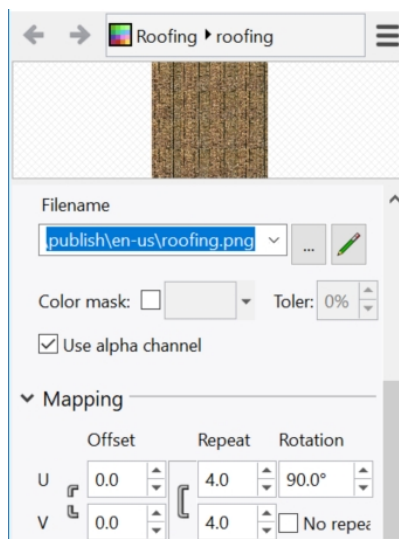

- Pick outside the panel and one the viewport to update the material.



- Rotate the **Perspective** view for the angle you wish to render.
- From the **Render** menu, click **Render**.

**Hint:** Explore the materials that are located in your **Render Content** folder. This will give you a better idea which materials you will need to create and which materials are ready for you to use in the library.

### Setting the Environment

The environment is a background color and optional texture you can configure for your model. Next you will assign a Rhino Environment called RhinoSky.

- Right-click **Properties** panel tab or any open panel tab.
- On the menu, click **Environment** panel.
- In **Environment** panel, click the plus + and from the menu select **Import From Environment Library**.
- In the Open file dialog, from the **\Render Content\Environments** location, select **MtMonadnock NH.renv** and click **Open**.
- In **Environment** panel, double-click **MtMonadnock NH.renv** or right-click and click "**Set as Global Environment**".

The MtMonadnock NH will now be set to the global environment.



- In **Environment** panel, under **Rotation** section, drag the rotation angle dial or type **320** degrees.



**Hint:** Watch the **Perspective** viewport as you are dragging the dial. It will update with a preview of the image at the current location.

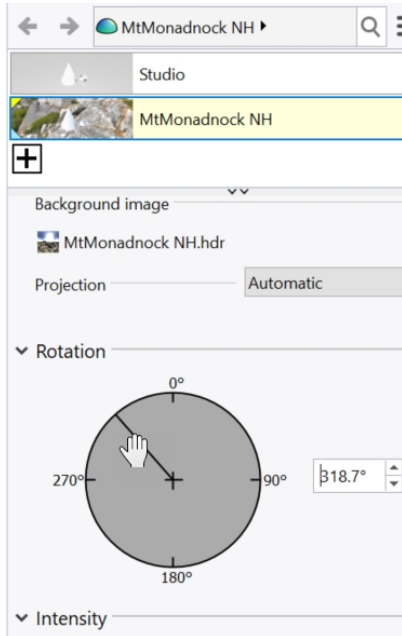

### Rendering to an image file

The **Save** command button in the render window saves the image in the render window to a file.

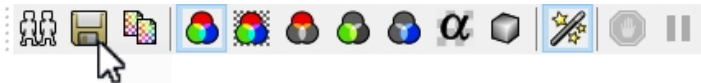

The render resolution is set in **Options** or on the **Rendering** panel.

1. In the **Tools** menu, click **Options**
2. In the **Options** dialog, click **Render**.
3. On the **Render** page, in the **Resolution and Quality** area, pick the resolution **800 x 600**, and click **OK**.

You can also set the render resolution from the **Rendering** panel, under **Resolution and Quality**.

4. From the **Render** menu, click **Render**



5. In the **Render** dialog, pick the **Save** button or from the **File** menu, click **Save-As**
6. In the **Save-As** dialog, under "**Save as type**", click **JPEG** and in the **File name** field, type **Gazebo01.JPG**. Click the **Save** button.

Your file can now be edited by any image editor.

### Rendering with Directional Lighting and the Skylight

Adding a directional light will add illumination when it is most necessary. The Skylight option will add an overall illumination to your model.

1. In the **Layers** panel, turn **on** the **Render\_lighting** layer.  
A directional light will appear. It is located in the NE quadrant of the model. It is oriented to point SW.  
Create your own directional lights with the **DirectionalLight** command.

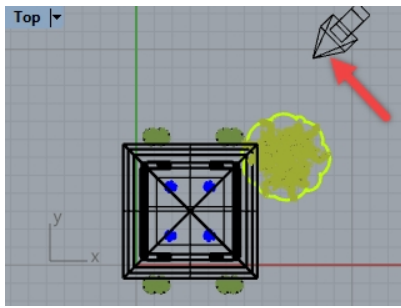

2. Right-click **Properties** panel tab or any open panel tab.
3. On the menu, click **Rendering** panel.
4. On the **Rendering** panel, in the **Lighting** section, uncheck **Skylight (360 env.)**  
The **Perspective** viewport is set to **Render** display mode and should update with the new lighting.
5. From the **Render** menu, click **Render**



6. In the **Save-as** dialog, under "**Save as type**", click **JPEG** and in the **File name** field, type **Gazebo02.JPG**. Click **Save**.

### Explore:

- There are additional Rhino environments in the *Render Content\Environments* folder. Pick the "+" button on the **Environments** panel to browse the **Library** for these environments.  
There are even more Rhino environments available for download at the web site [Food4Rhino](#).
- Trees in this exercise were created with plugin [Lands Design for Rhino](#) developed by [Asuni Group](#)

# Chapter 15 - Printing and Layouts

## Printing

The **Print** command will let you print one viewport at a time or Print a collection of viewports on the layout.

### Exercise 15-1 Printing the model

1. Open the model **Print.3dm**.
2. Make the **Top** viewport active.
3. On the **File** menu, click **Print**.
4. In the **Print Setup** panel, under **Destination**, select a printer as the built-in **Rhino PDF**, **Letter** paper, **Landscape** orientation, **Raster Output**, and **Display Color**.

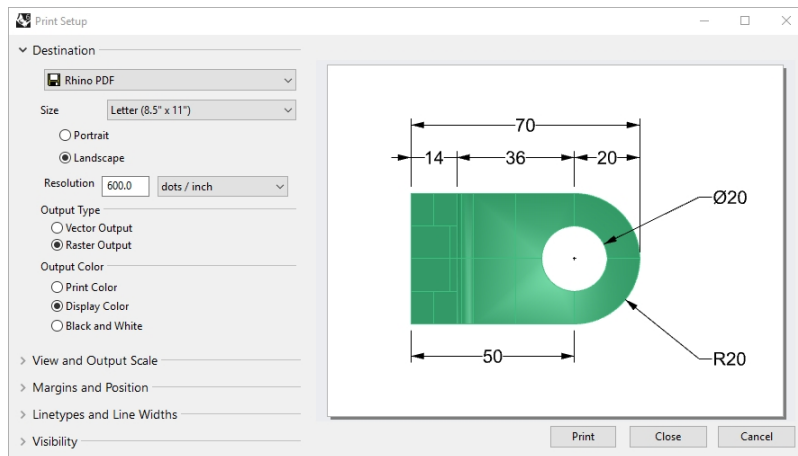

5. Under **View and Output Scale**, viewport should say **Top**, and select **Extents** button.
6. Also under **View and Output Scale**, select **Scale** of **2:1**, **On Paper 1.0 Millimeter**, and **In Model 0.5 Millimeter**. Rhino will print .5 mm of the model in every 1 mm on the printed sheet.

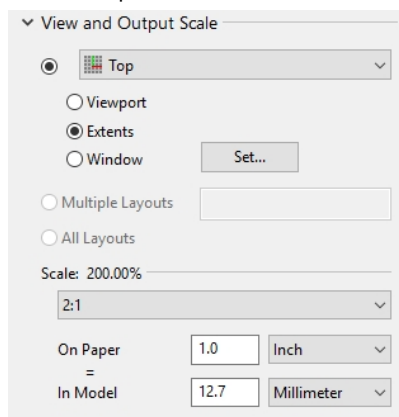

7. Pick the **Print** button.
8. In the **Save PDF File** dialog, specify name and location to save the PDF.

### Exercise 15-2 Layouts

Rhino has a Layout feature that will print multiple details of the model on one sheet. The details can have different scales, sizes, layer color, layer visibility, and object visibility. In addition, you can add multiple layouts to a model.

## Add a layout

- In the **Layers** panel, make the **Details** layer current.
- On the **View** menu, click **Layout** and **New Layout**.  
Or click the  on the **Viewport Tabs** bar, located below the Rhino graphics area.



The layout name is **Page 2**, by default. The sheet size is offered in the units of the model.

However, selecting a different unit system will let you specify the sheet in more familiar units, without changing the layout units. Rhino will apply the conversion to create the correct size sheet in your layout units.

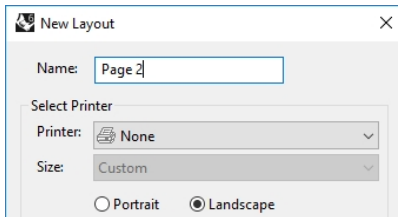

- In the **New Layout** dialog, set **Width** to **11**, select **Inches**, and set **Height** to **8.5**.
- Set the **Initial Detail Count** to **4**. Click **OK**.

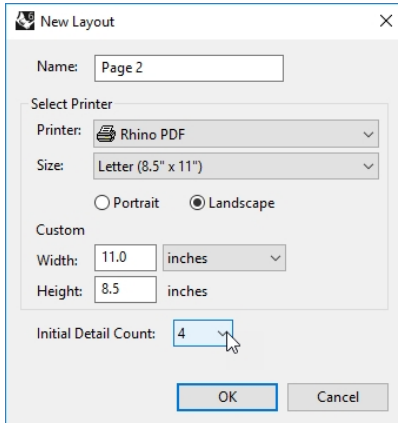

- Double-click** to activate the **Perspective** detail.
- On the **View** menu, click the **Shaded** display mode.

Page 2 - Detail (Perspective)

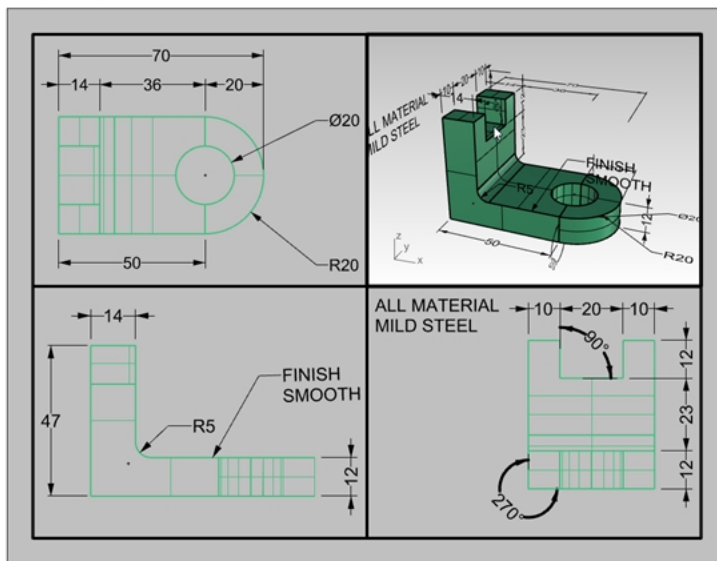



## Configure the perspective detail

To suppress the display of geometry in any detail, hide the object in the detail or turn off the layer in the details. Objects are hidden in the details with the **HideInDetail** command and made visible with the **ShowInDetail** command. In addition, the **Layers** panel allows a layer to be turned off only in the detail, but remain visible in other details or viewports.

1. **Double-click** to activate **Perspective** detail.
2. In the **Layers** panel, scroll to the right or undock the panel and stretch it horizontally.
3. Select the **Dimensions** layer, and click the light bulb icon in the **Detail On** column.

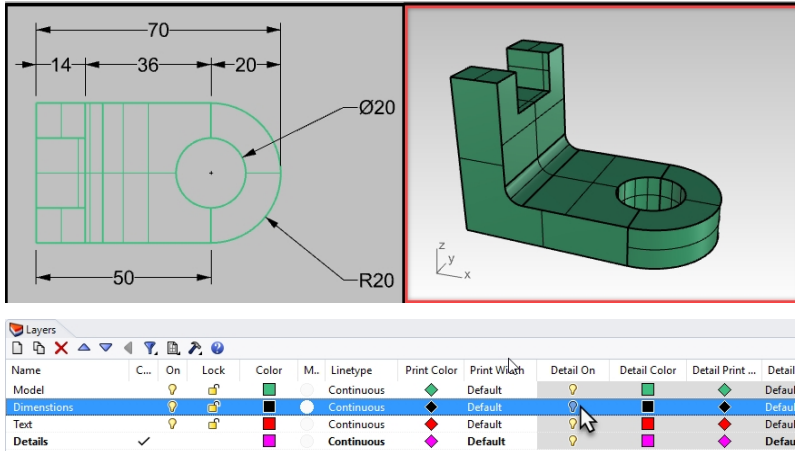

All the objects on the layers that were turned **off** in the **Detail On** column are not visible in the **Perspective** viewport but remain visible in all other details.

**Note:** In the **Layers** panel, visibility of model and detail layer settings is control by the **View** button. In the images above, **View all layer settings** is checked.

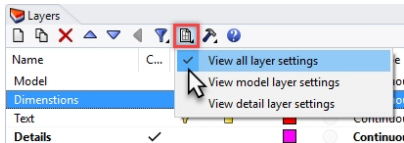

4. **Double-click** the **Perspective** detail to de-activate.
5. Select the boundary edge of the detail.

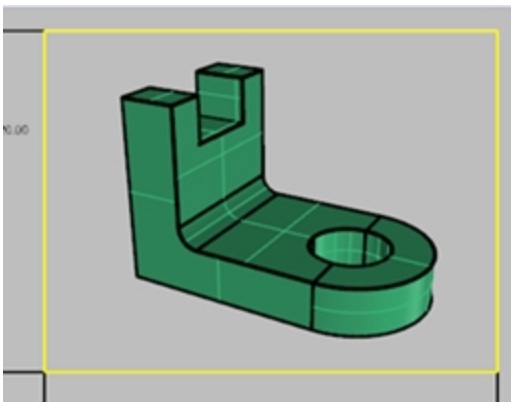

- In **Object Properties**, confirm the **Print Width** of the detail is set to **No Print**. The edge of the detail will not print unless you assign a width.

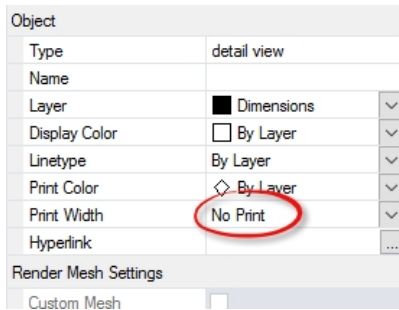

### Assign a scale to details

Details that are parallel can get a scale assigned to them. The scale will tell Rhino how many model units are in each paper unit. By assigning the scale to the detail, the layout can be plotted 1=1. Also by assigning the scale to the detail, details can have different scales.

- Select the **Top** detail.  
Do not double-click to activate.
- In the **Properties** panel, click the **Detail** icon.
- In the **Scale** area, set **1.0mm** on layout equal to **1mm** in model.  
The scale is now set to 1=1.  
If you set 1mm in the layout equal to 2mm in the model detail, it is half size or 1=2.  
If you set 1mm in the layout equal to 10mm in the model detail, the scale is 1=10.

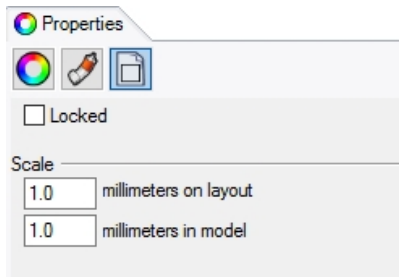

- Make detail active by Double-clicking it and pan geometry to center in viewport.
- Deactivate detail by Double-clicking.
- Select detail and in the **Properties** panel, click the **Detail** page, and then click the **Locked** check box.  
Details that are locked prevent zooming or panning.
- Repeat this procedure for the **Front** and **Right** details.

### Label details

- Make a new layer called **Notes**.
- Make the **Notes** layer **Red** and current.
- Turn **Ortho** off, and deactivate any details.  
You should be on the layout and not in an active detail.
- On the **Dimension** menu, click **Text Block**.

5. In the **Text** dialog set the **Height** to **7mm** and type **Top View**.

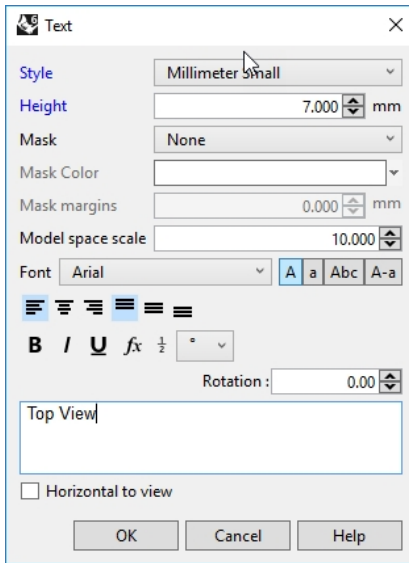

6. Pick the **OK** button.  
7. Pick a point on the layout to locate the text below the **Top** detail.

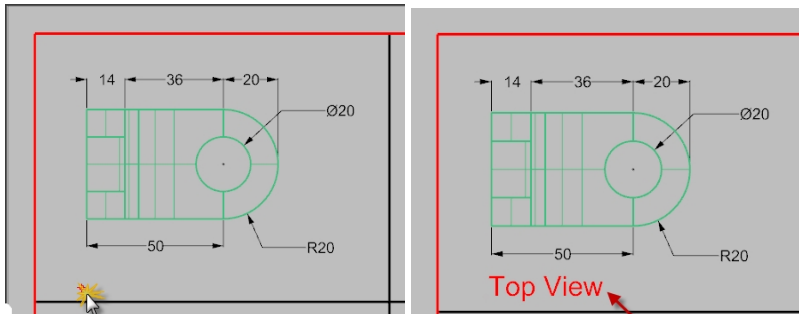

8. Repeat to add the labels **Front View** and **Right View**.

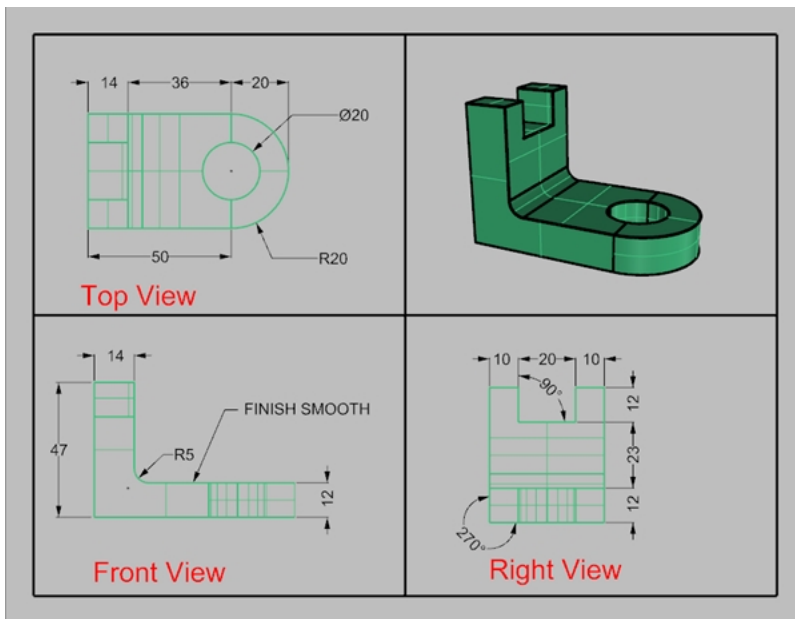

#### Add a border

1. On the **Curve** menu, click **Rectangle, Corner to Corner**.
2. Snap to the lower left corner of the **Front** detail boundary and the upper right corner of the **Perspective** viewport boundary.

3. Select the border.
4. In the **Properties** panel, on the **Object** page, click **Print Width**, and then click **0.70mm**.

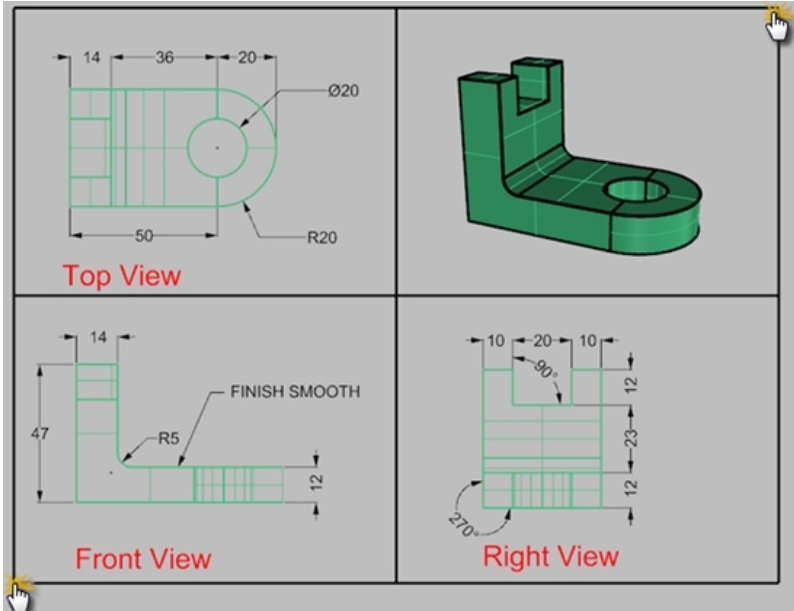

5. Right-click on the **Layout Title (Page 2)**, and then click **Print Preview**.  
The layout has a thick border around the detailed viewports.  
You can also add a title block at this stage if you choose.

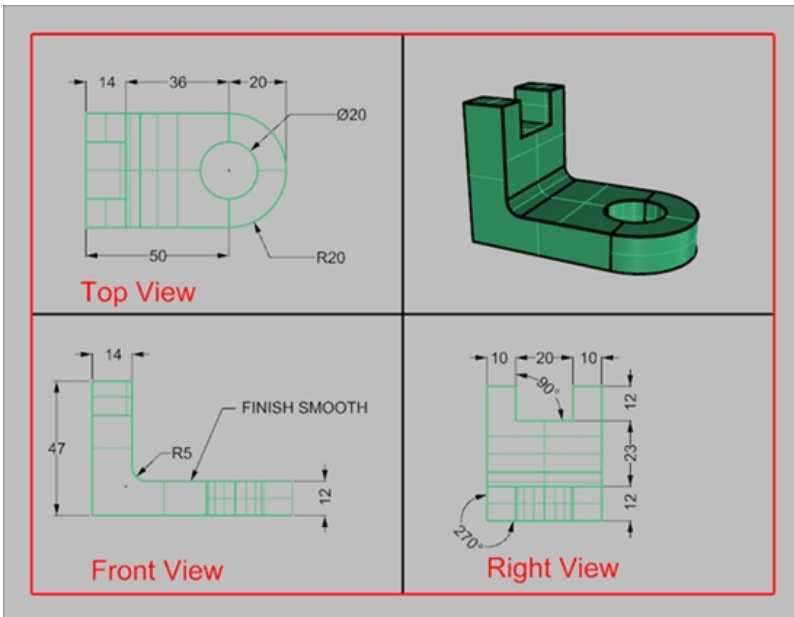

**Print the layout**

1. On the **File** menu, click **Print**.
2. Select a physical printer or a virtual printer like **Rhino PDF**.
3. Select sheet **size** as **letter** or **11x81/2** landscape.

- In the **View** and **Output Scale** area, set the scale to **1=1**.

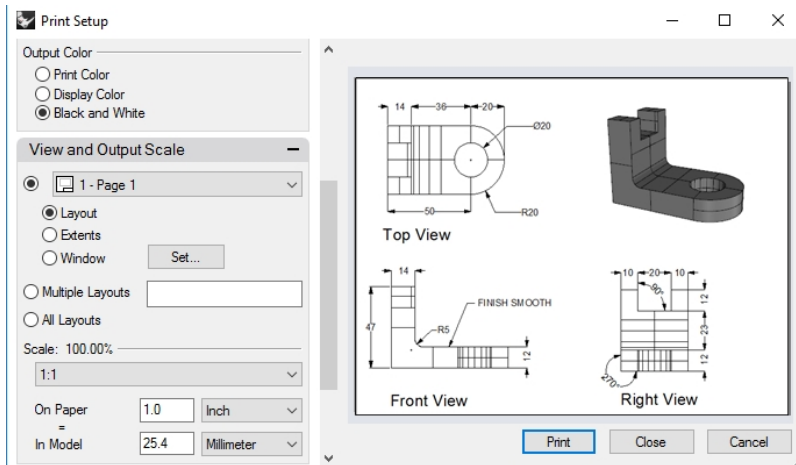

- Toggle **Output color** between **Black & White** and **Display Color**.
- Click **Print** to print; **Cancel** if no printer is available.
- Save** the file.

## Scaling and locking details on a layout

### Exercise 15-3 Layout the Frigate

- Open the model **SimpleLayout\_Print.3dm**.

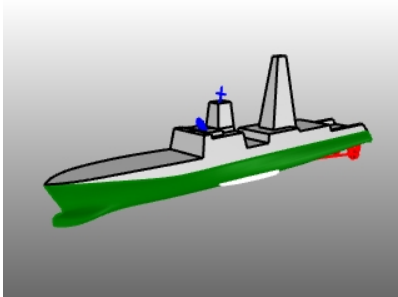

- Click in the **Top** viewport.
- On the **View** menu, click **Layout**, click **New Layout**.
- Click the **Printer** list, and select **Rhino PDF**.
- Click the **Size** list, and select in inches **Tabloid (11" x 17")** or in millimeters **432 x 279.5**.
- In the **New Layout** dialog, click **Landscape**.
- Set the **Initial Detail Count** to **4**.

8. Adjust any other options appropriate for your printer or plotter, click **OK**.

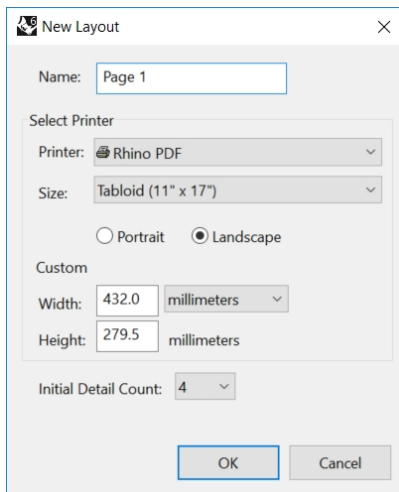

A layout page opens and a new viewport tab labeled Page 1 appears at the lower edge of the Rhino window. The new layout has four detail views, showing the object from the same direction as the four default Rhino viewports. Details are windows into the 3-D model. They can be activated as modeling viewports by double-clicking in the viewport.

### Set scale and lock details

1. **Double-click** in the **Right** detail.

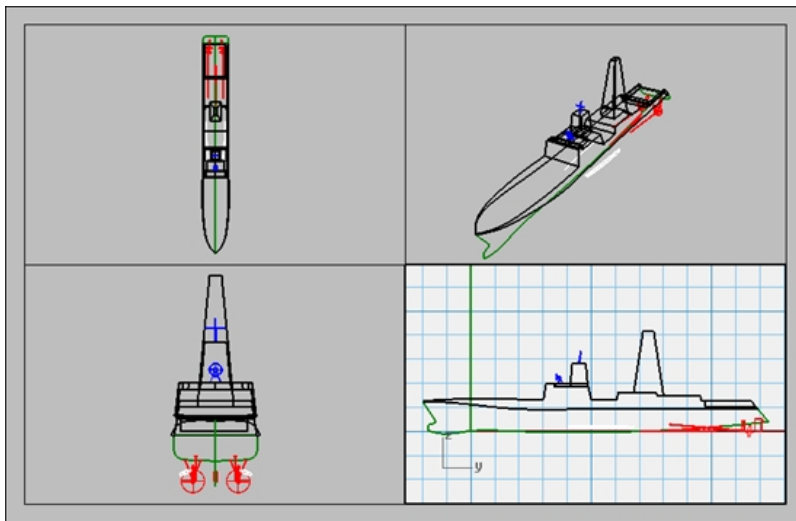

2. If the **Properties** panel is not open, from the **Panels** menu, click **Properties**  
**Note:** With no objects are selected in the model, the **Properties** panel shows the viewport properties. With no detail active, the properties shown are for the layout as a whole.

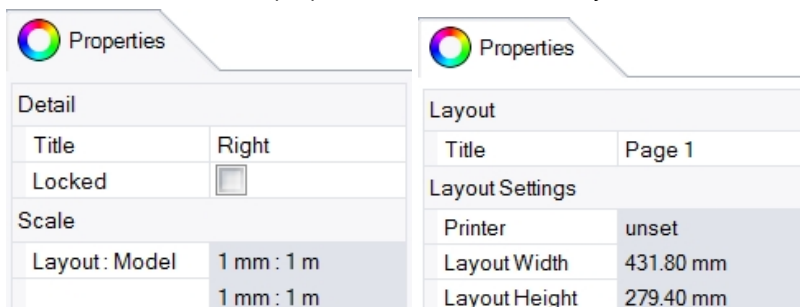

3. Click the **Edit** button to edit the title, and size and printer properties.  
 4. In the Command line, for the **Distance on layout (mm)**, set it to **1** and press **Enter**.  
 5. In the Command line, for the **1.000 millimeter on layout = Distance in model (m)**, set it to **1** and press **Enter**.

- Change the title to **Right Profile**, and **Lock** the detail.
- Repeat this in the **Top** and **Front** details to set all of these details to the same scale.

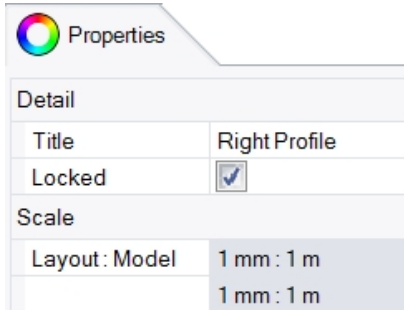

- Activate the **Perspective** detail.
- On the **View** menu, click **Shaded**.

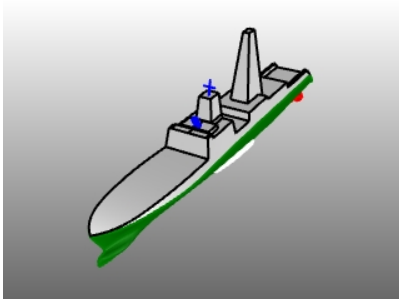

#### Draw borders and title blocks in the layout space

- Double-click in the Perspective detail to deactivate it and make the layout space active.
  - In the **Layers** panel, make a new layer named **Title Block** and make it current.
  - Draw a **Rectangle** (*Curve>Rectangle>Corner to corner*) around the viewports on the Layout.  
First corner: **10,10**  
Other corner or length; **422,269**
  - Next, resize the details borders to match the image.
- Hint:** Use control points, Gumball scale and move, Osnap, Smart Track, etc.

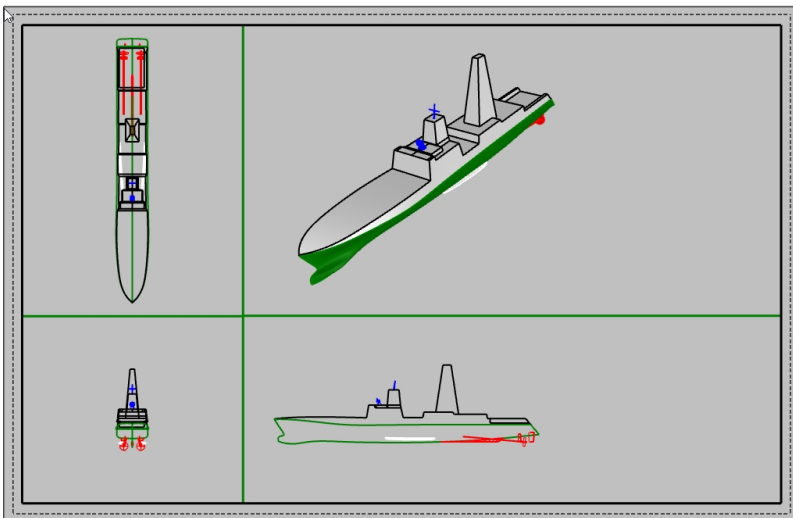

- On the **File** menu, click **Insert**.
- On the **Insert** dialog, check **Prompt** under **Insertion point**, uncheck **Prompt** under **Scale** and **Rotation**. Also under **Scale**, keep the check in **Uniform**.

- On the **Insert** dialog, click the **File** icon .

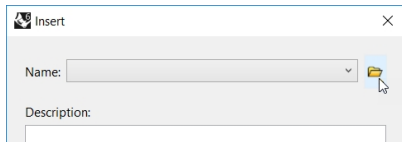

- In the **Select File to Insert** dialog, navigate to and pick the file **TitleBlock\_Meters .3dm**. Click **Open**.
- In the **Insert File Options** dialog, under the **Block definition type** area, click **Embedded**. Click **OK**.
- In the **Insert** dialog, under **Insert as** area, click **As Group**.  
Next under **Scale** with **Uniform** check, type **1000**. Click **OK**.
- For the **Insertion Point**, use the **End pt** osnap and pick the lower right corner of the rectangle.  
A title block is inserted on the layout.

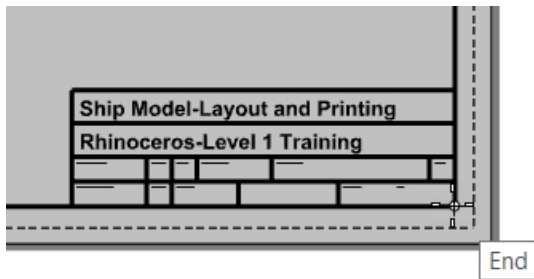

- Click to select the title block. It is a group and will select as one.
- Change the title block to the **Title Block** layer. In the **Properties** panel, under the Layer list, click the layer **Title Block**. All the geometry in the group will be assigned to the selected layer.
- You can add information to the title block with the **Text** command.  
To edit the text in the group, **Shift** + **Control** (sub object selection) and pick on the text.  
On the **Text Properties** page in the **Properties** panel, you can change the text string, the formatting, font, justification and more settings.

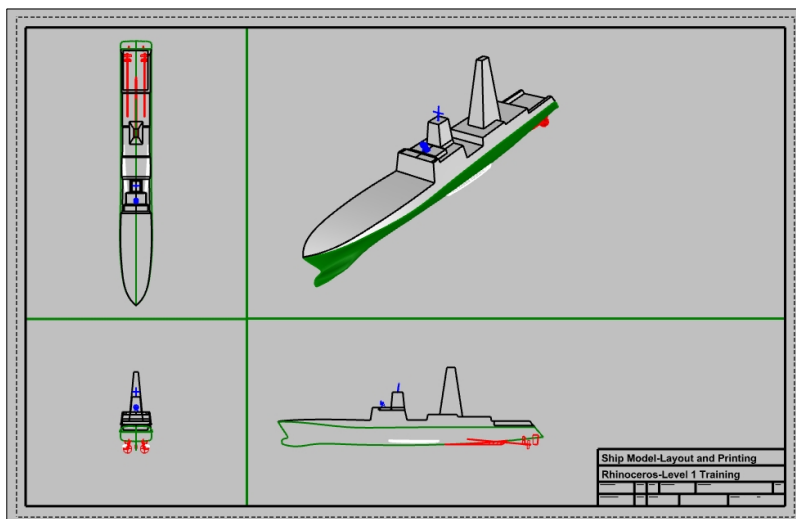

### Add dimensions to the layout space

On the layout use **Linear** dimensions to measure some features. The dimensions are located on the layout. They will not display in the model views.

- On the **Tools** menu, click **Options**. Click **Annotation Style**, select **Default** style and click the **Edit** button.
- In the right pane, under the **Font** section, change the **Height** to **2**. Click **OK**.
- In the **Layers** panel, make a new layer named **Dimensions** and make it current.
- On the **Dimension** menu, click **Linear Dimension**.



- Use the **Continue=Yes** option and **Baseline=Yes** options to create both chain and baseline dimensions.
- Add more dimensions as needed to the other layout viewports.

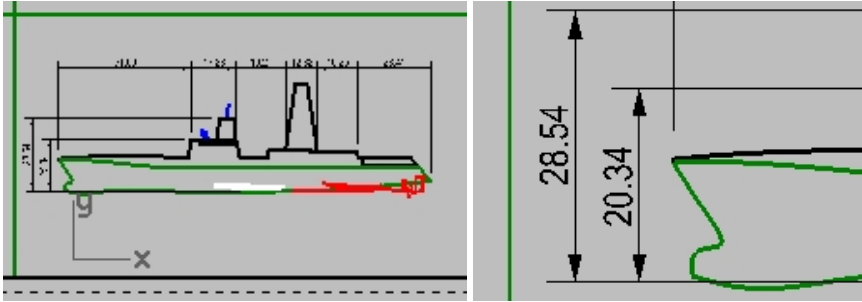

### Set linetypes and line weights for curves

These are used in printing and can be displayed in the Rhino views using the **PrintDisplay** and **LinetypeDisplay** commands.

- In the **Layers** panel, hold down the **Ctrl** key and select the **Border** and the **Title Block** layer.
- In the **Print Width** column, change the width to thicker weight of **.7mm**.
- Next select only the **Dimensions** layer. In the **Print Width** column, change the width to thicker weight of **.5mm**.
- Right-click the viewport title **Page 1** and from the menu, click **Preview**.

Notice the difference in thickness of the curves.

Linetypes can be adjusted in a similar way.

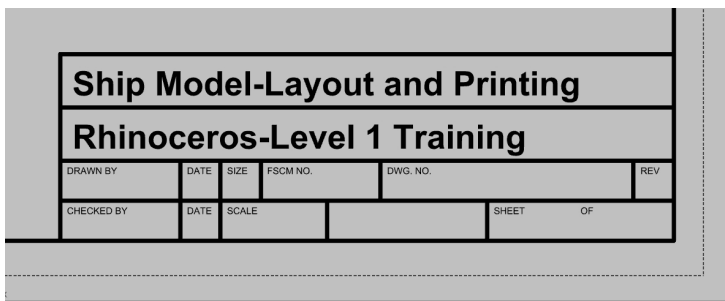

### Print to Rhino PDF

- On the **File** menu, click **Print**.
- On the **Print Setup** dialog, make the following changes:  
Under **Destination**, set the printer to **Rhino PDF**, set the **Size** to **Tabloid (11" x 17")** and **Landscape**, **Output Type** as **Vector**, **Output Color** as **Display Color**.

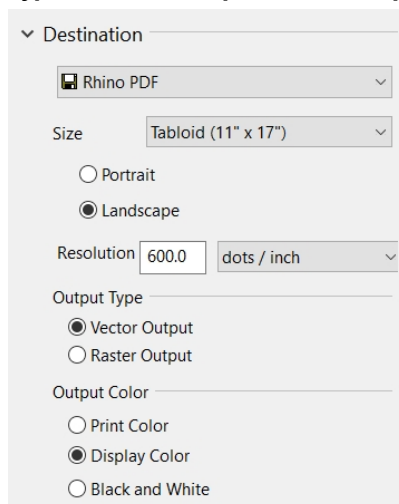

- In the **View and Output Scale** section, under **Scale**, click **1:1**.

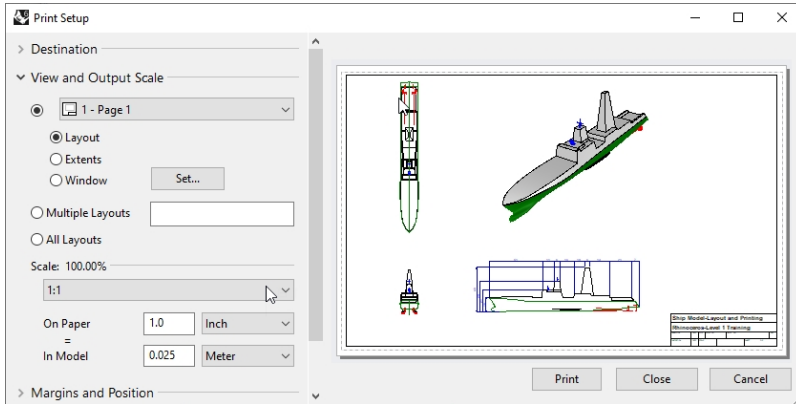

- In the **Linetypes and Line Weights** section, under **Default line** click **.35mm**. This will affect all the objects and layers whose **Print Width** is set to **Default**.

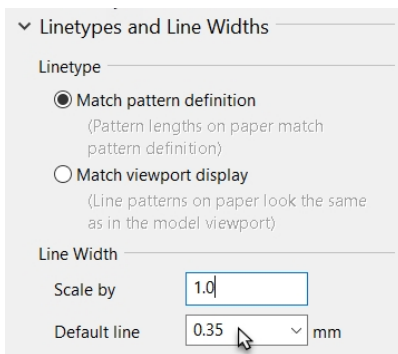

- Pick the **Print** button and in the **Save PDF File** dialog, pick a location. The file name will default to the name the current file.
- View and print the PDF with Adobe, Microsoft Edge or your favorite PDF viewer.

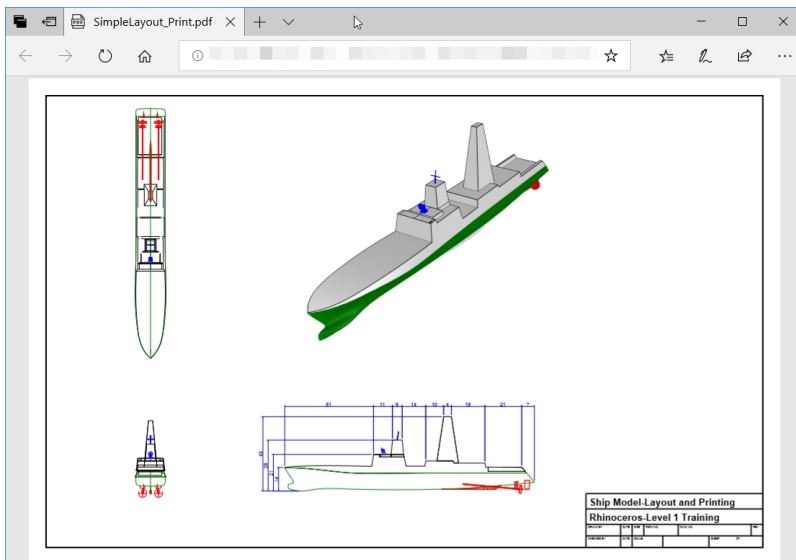

# Chapter 16 - Intro to Grasshopper

Grasshopper is a visual scripting platform that is included in Rhino 6.

- With Grasshopper, you will write scripts to automate tasks by dragging controls on to a canvas which is its main interface.
- Parameters like the **Number Slider**, **Graph Mapper**, **Random** and **Jitter** are used to drive infinite design options.
- The Grasshopper design is immediately previewed in the Rhino's application without generating geometry.
- When final design is selected the geometry is created by "baking" into the Rhino object.

**Note:** **Bike Wheels.GH** is included in the models folder. You can also print **Bike Wheels.JPG** and follow along with the exercise.

## The Grasshopper UI

Before you start using Grasshopper, you will need to know the parts of the Grasshopper screen. Using the graphic below, study the names so you will be prepared to do your first Grasshopper definition.

### Grasshopper Canvas

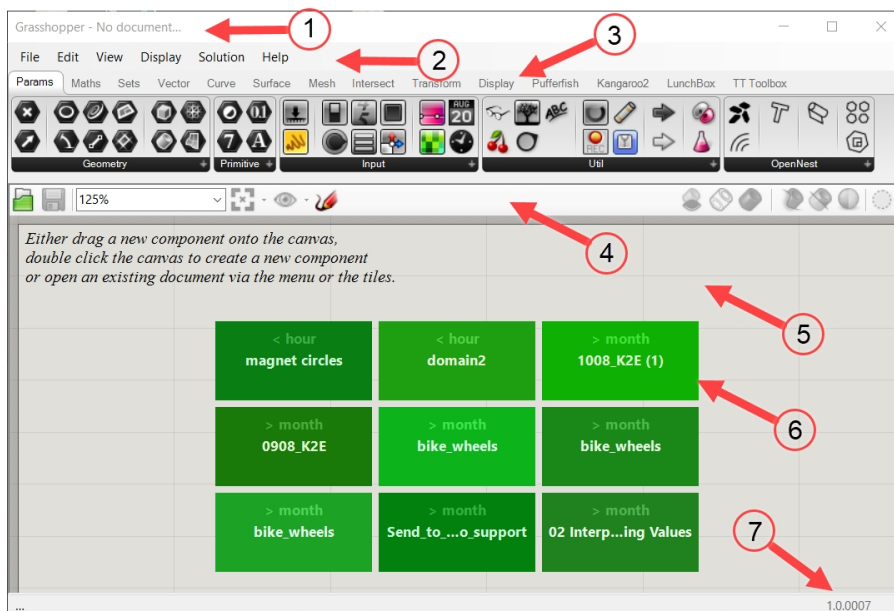

1. Window title bar
2. Main menu bar
3. Collection of components
4. Canvas toolbar
5. Grasshopper canvas
6. Recently used GH definitions
7. Current version display

## Category tab and Sub-category panel

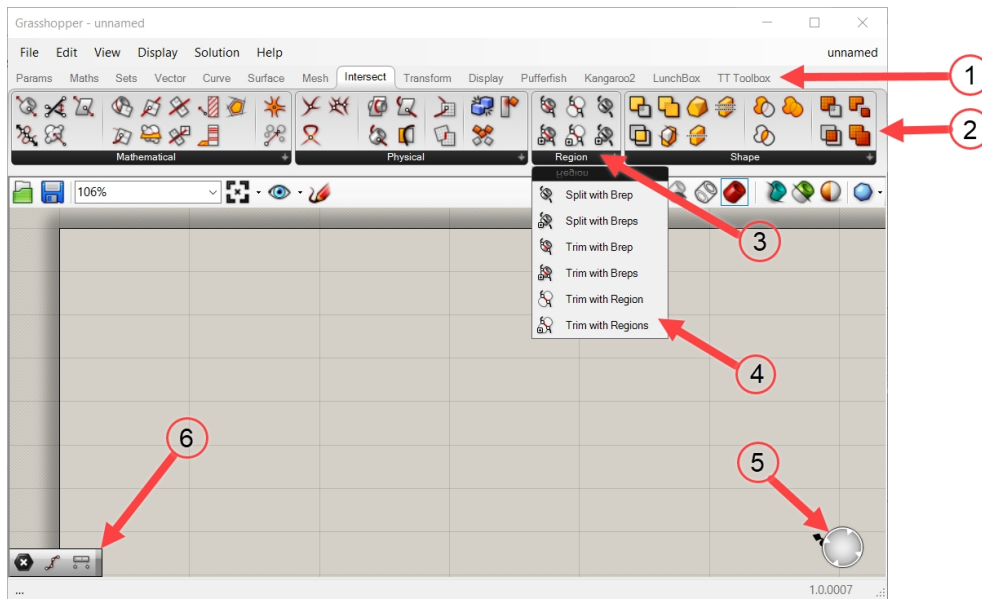

1. Category tab
2. Sub-category panel
3. Click Black Bar to open Drop-down menu.
4. Drop-down menu with additional commands
5. Compass
6. Markov widget

## Opening the Grasshopper Canvas

1. Begin a new model with template **Small Objects Inches**.
2. Open the Grasshopper canvas by picking Grasshopper button  in the **Standard** toolbar or typing: **Grasshopper** in the Command line.

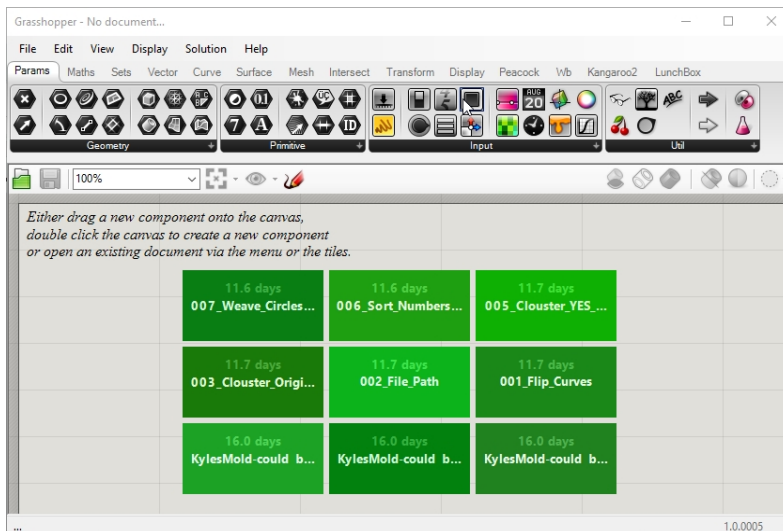

- Double-click on the title bar at the top of the Grasshopper window to expand and compress it. However, leave it in the open state. (Windows only feature)

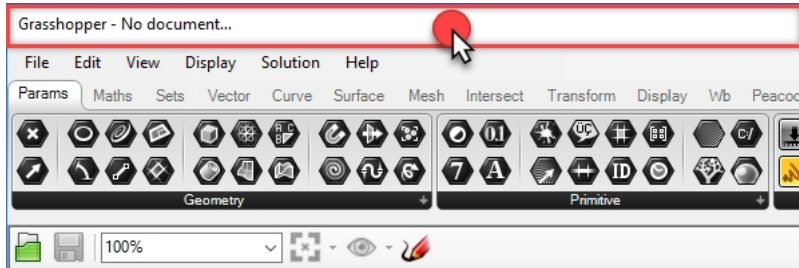

## The Grasshopper Settings

There are a couple settings that you will use to control the way the Grasshopper interface will look.

- From the Grasshopper **File** menu, click **Preferences**.
- The **Grasshopper Settings** dialog will appear.
- In the left pane, highlight **Interface**.
- If you are teaching Rhino to younger students, in the right pane, slide the **Content Filter** to **Strict**. This will display the Grasshopper icons in a way that is acceptable to younger users.
- Check the option **Show obscure components**.

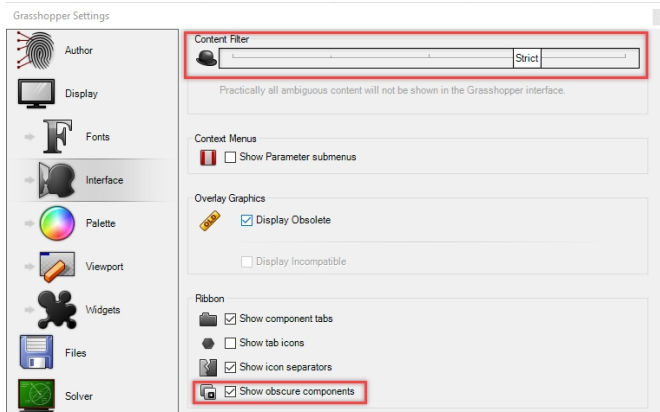

- Pick the "X" in the upper right corner of the dialog to save and close **Grasshopper Settings**.

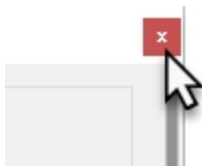

- On the **Grasshopper** menu, pick **Display**.
- From the **Display** menu, turn on:

### Draw Icons

### Draw Fancy Wires

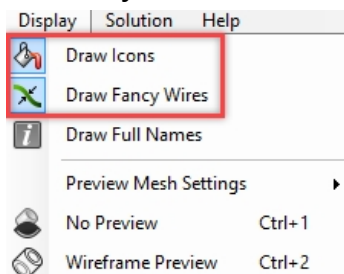

## Canvas Search Feature

In addition to inserting a component from the Grasshopper menu, tabs and panels, you can find a component by name by double clicking in an open space on Grasshopper canvas.

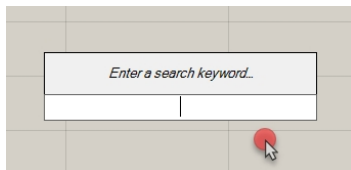

A search box will pop-up and you can type in the name of the component to be inserted. A key word search will display all the components that satisfy the request.

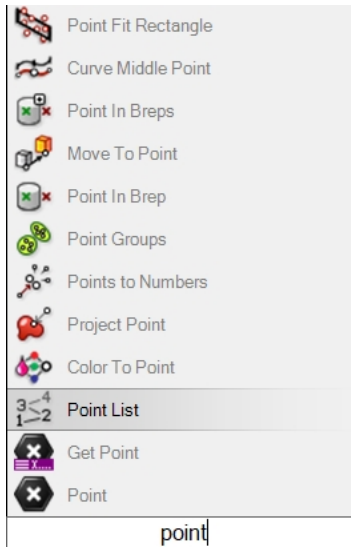

Pick on the command name in the list to insert it on to the Grasshopper canvas.

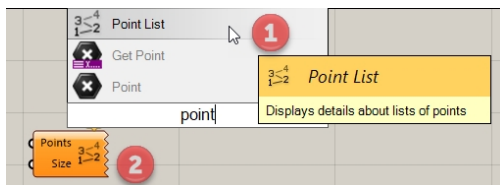

## The Finder

When you open a completed Grasshopper definition file, you can trace any component or parameter back to its location on the Category tab. Grasshopper will display a finder arrow that will mark where the component is located on the **Grasshopper** menu. Reverse engineering a Grasshopper definition that you find on the Forum or are given by an expert user is an excellent way to learn more advanced concepts in Grasshopper.

1. From the Grasshopper **File** menu, click **Open Document**.
2. Navigate to the files that you downloaded for this training, and open **Bike Wheels.GH**.
3. While hovering over any Grasshopper parameter or component on the canvas, hold down the **Control** + **Alt** keys, while pressing and holding the Left mouse button . The red finder arrows will appear.

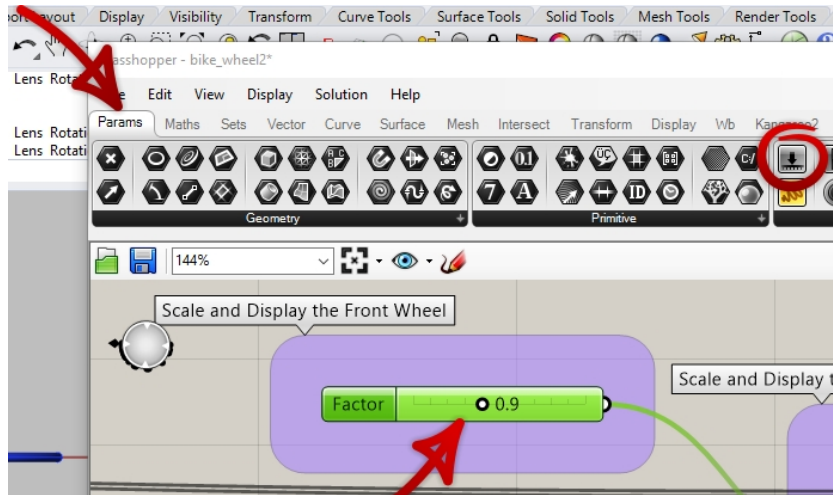

4. You will see the arrows while you have the keys and the mouse button pressed. When you let go, the finder arrow will disappear.  
**Hint:** Use **Command** + **Alt** with Rhino for Mac.  
This is a helpful way to "reverse engineer" a Grasshopper Definition.

Let's get started with our first simple Grasshopper definition.

## Exercise 16-1 The Bike Wheel

### Create the Circles

1. On the Grasshopper **File** menu, pick **New Document**.
2. On the Grasshopper **Curve** tab, and the **Primitive** panel, drag and drop two **Circle** components on to the Grasshopper canvas.

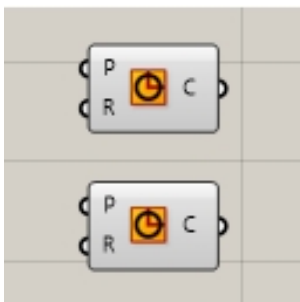

*Grasshopper Canvas*

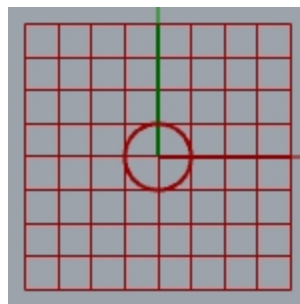

*Rhino's Top Viewport*

3. Double-click on the Grasshopper canvas to open a dialog box with the prompt **Enter a search keyword**.

4. Type **Number** and pick **Number slider** from the menu.

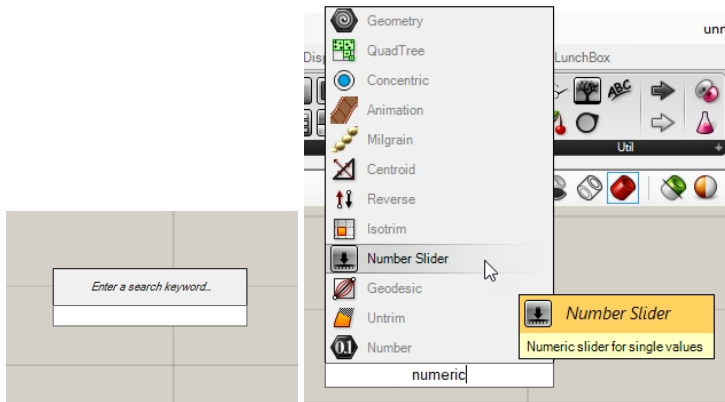

5. A **Number slider** parameter will be added to the canvas.
6. Drag the output connector from the **Number slider** to the input **R** of the Circle.

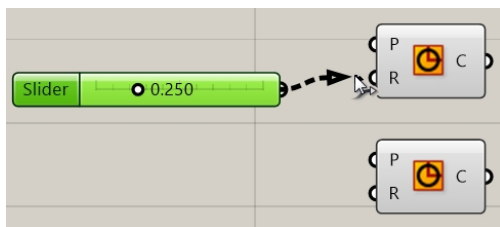

7. Now drag the slider and see the radius of the circle in the top view update.

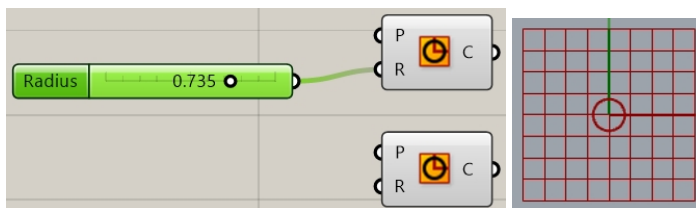

8. To create the second **Number slider**, double-click on the canvas and type: **24<32<36**. With this syntax, the **Number slider** will be set to 32, range from 24, to 36, and output integer values. In other words, the domain of the **Number slider** is between 24 and 36.

9. Connect in the **Number slider** output to the input **R** on the second circle component.

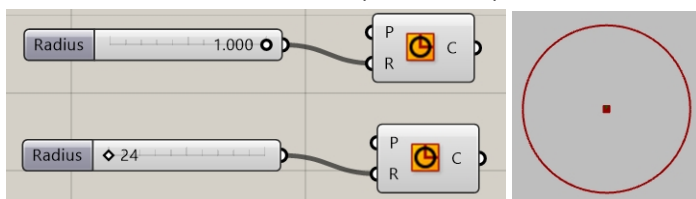

10. Double-click on the **Radius** label on the first number slider. The Slider dialog will appear.





11. Edit the **Min** and **Max** values. Set the **Min** to 1, the **Max** to 10, and the **Rounding** to N or Natural number (Integer).

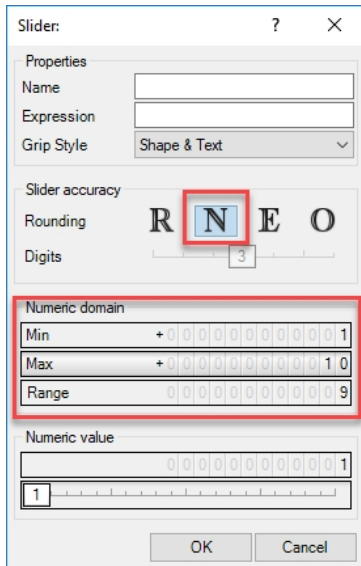

12. Pick the **OK** button to close the dialog.
13. Drag the first slider to 6.

### Divide the Circle

1. On the **Curve** tab, under **Division** panel, click **Divide Curve** and drop two on to the canvas to the right of the circles.
 

**Hint:** To copy a component, tap **Alt** key while dragging and pick to place the copy.
2. Connect the output circle curve to the **Curve** input on the **Divide Curve** component. Repeat for the second circle.

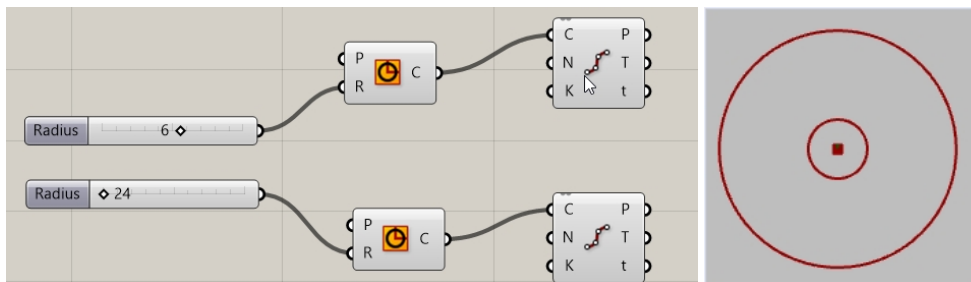

### Connect the Points

By default, the **Divide** component generates 10 divisions or 10 points on each circle. Now you will make a slider to control that number of points and connect the points to a line component.

1. Double-click on the Grasshopper canvas and create a slider by typing **5<10<20**. This will create a **Number slider** that is set to 10, and whose domain is between 5 & 20.
2. Connect the output of the **Number slider** to the **N** of both **Divide** components.
 

The number slider will control the number of divisions for both Divide components
3. Now drag the slider and watch the points increase and decrease.

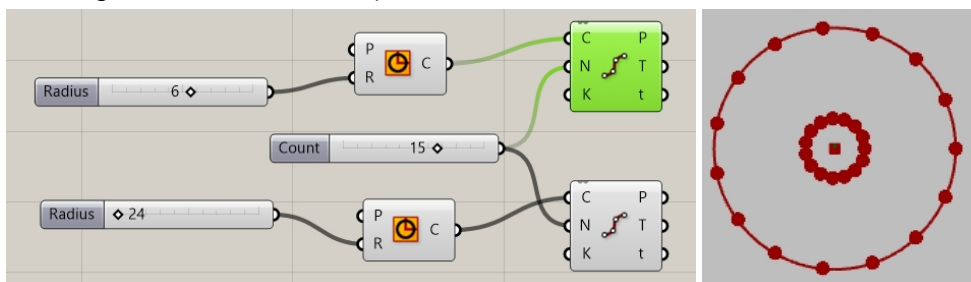

- On the Grasshopper **Curve** tab, from the **Primitive** panel, pick **Line** and place it on the canvas, to the right of the **Divide** component.
- Connect the output Points from the first divide component to the **Line** input **A**.
- Connect the output Points from the second divide component to the **Line** input **B**.  
The lines are now connecting the points which are dividing both the circle curves.

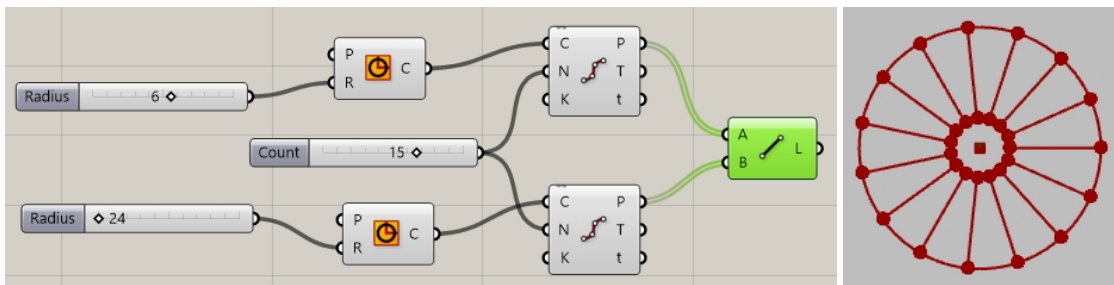

- Right click on the **Divide** components and pick on **Preview** to disable the preview of points.

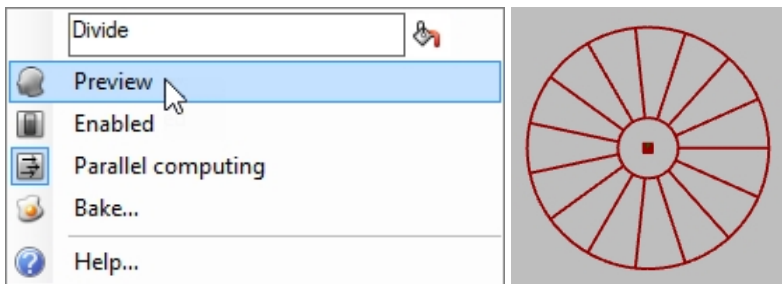

## Pipe the Curves

The curves will be used to generate surfaces for the wheel and spokes of the wheel.

- On the Grasshopper **Surface** tab, under **Freeform** panel, click **Pipe** and place it on to the Grasshopper canvas, to the right of the **Line** component.
- Add a second **Pipe** component and place it on to the Grasshopper canvas, below the first **Pipe**.
- Connect the output from **Lines** to the **Curve** input of the first **Pipe** component.

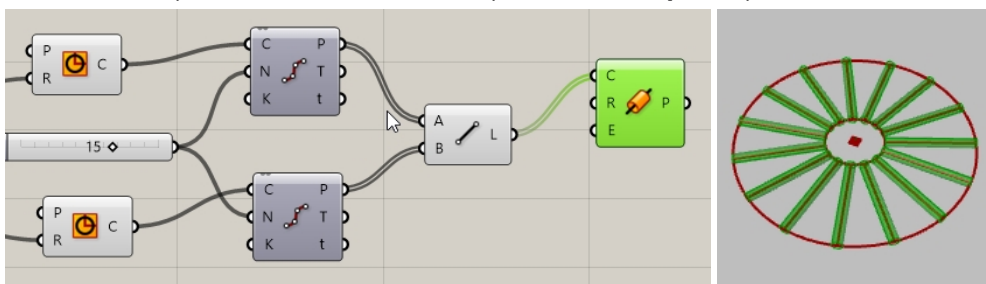

- Double-click on the Grasshopper canvas and create a slider by typing  $.25 < 1 < 2$ . This creates a **Number slider** that is set to 1, and whose domain is between .25 & 2.00.

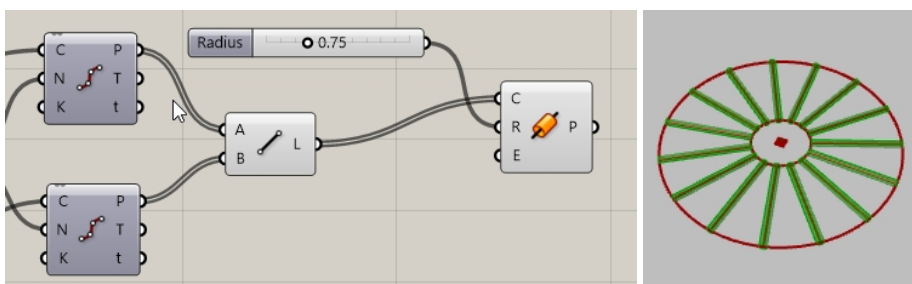

- Connect the output from the **Number slider** to the **Radius** input of the first **Pipe** component.

- Connect the output from second **Circle** curve to the input **Curve** on the second **Pipe** component.

**Hint:** To allow multiple inputs, press the **Shift** key while connecting the outputs to the input.

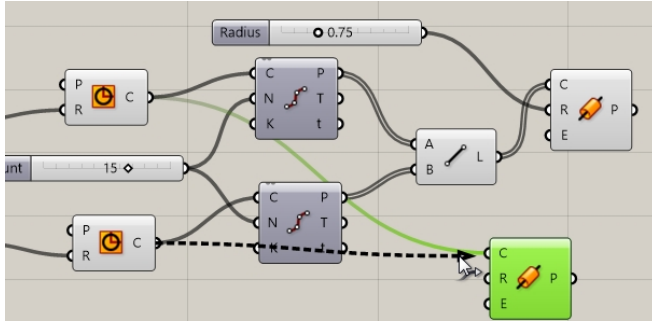

- Double-click on the Grasshopper canvas and create a slider by typing **.50<1<3**. This creates a **Number slider** that is set to 1, and whose domain is between .50 & 3.00.
- Connect the output of the last **Number slider** to the input of the radius of the second **Pipe** component.
- Drag the slider bar and watch the radius of the pipe change.

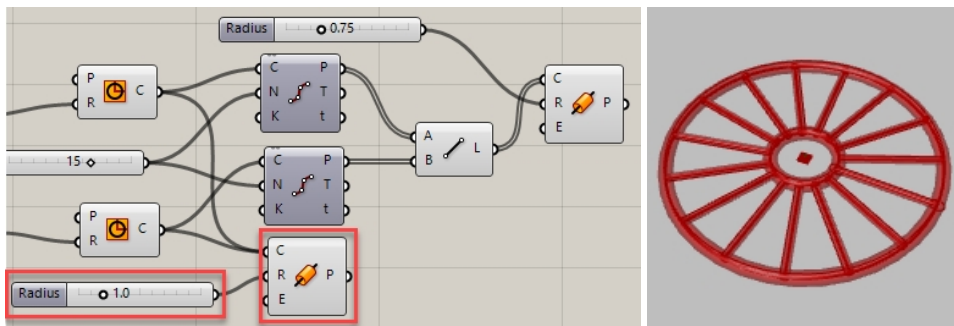

## Orienting the Wheel

The wheel needs to be oriented parallel to the Front view or to the World XZ plane. To do this, you will provide a plane to orient the circle.

- On the Grasshopper **Vector** tab, under **Plane** panel, click the **XZ Plane** component and place two **XZ Plane** on to the Grasshopper canvas, to the left of each circle component.
- Connect each **Plane** output from **XZ plane** to the Plane input of each **Circle** component. The entire wheel design is now oriented in the Front view or the World XZ plane.

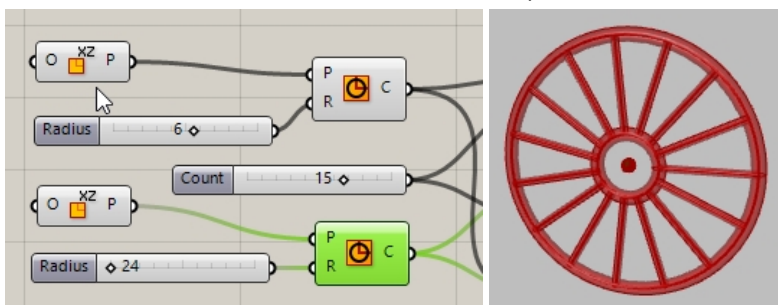

## Preview the Wheel in Custom Color

The geometry is being previewed in the default Grasshopper colors. In this section, you will assign a colored material to the wheel and the spokes in Grasshopper.

1. On the Grasshopper **Display** tab, under the **Preview** panel, drag and drop two **Custom Preview** components and place them to the right of each Pipe component.
2. Connect the output from **P** from **Pipe** components to the input **Geometry** of the **Custom Preview** components like shown in the image below.

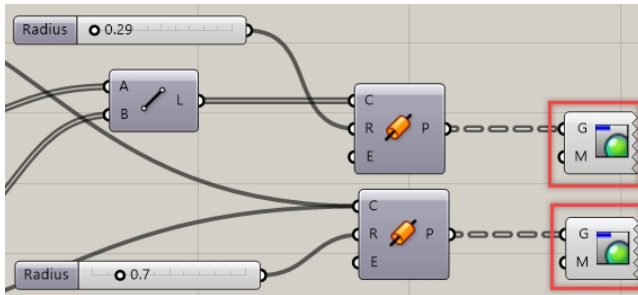

3. On the Grasshopper **Params** tab, under **Input** panel, drag and drop a **Color Swatch** component to the left of the **Custom Preview** components like shown in the image below.

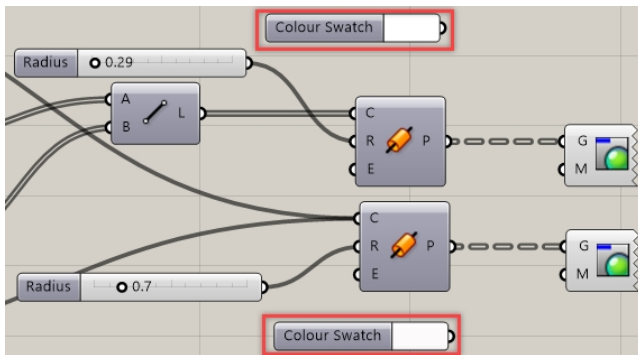

4. Drag the output from the **Color Swatch** components to the input Material override on the **Custom Preview** components as shown in the image below.

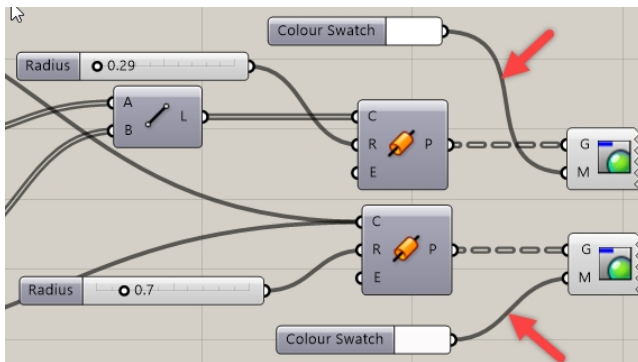

5. Double-click on the **Color Swatch** components to select a custom color from the color picker dialog.



The dialog has sliders to set the Hue, Saturation, Value, and Alpha transparency of the custom color. Pick **Accept** when the color preview is as you like.

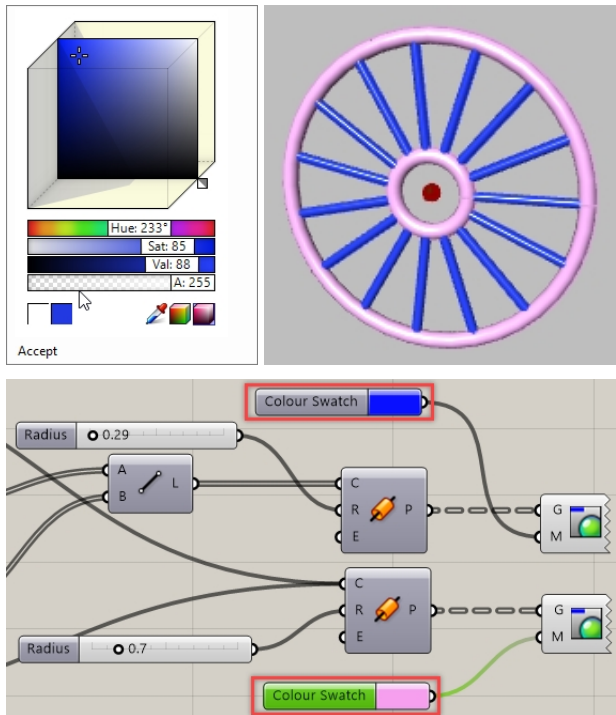

- Pick **Save Document** from the Grasshopper **File** menu, or pick the **Save** icon from the Grasshopper canvas toolbar.



- Save definition as **My Bike Wheel.gh**.

## Bake The Wheel

The wheel geometry is still only being previewed in Rhino. To send the geometry to Rhino for editing, rendering, printing and more, you will need to Bake from certain components. During the bake, there are options to assign the geometry to a target layer and group the geometry.

- On the Grasshopper **Params** tab, under **Primitive** panel, click **Data** component.  
The **Data** component will make a copy of the input to be used collectively in another operation, like **Bake**.
- Connect the output from the both **Pipe** components to the Input of **Data**.  
**Hint:** To allow multiple inputs, press the **Shift** key while connecting the outputs to the input.
- Right click over **Data** and click **Bake** from the menu.

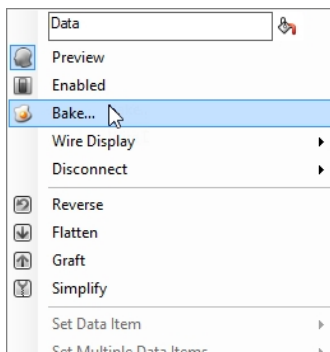

4. Select **Layer 03** and **Yes, Please** to **Group** the output.

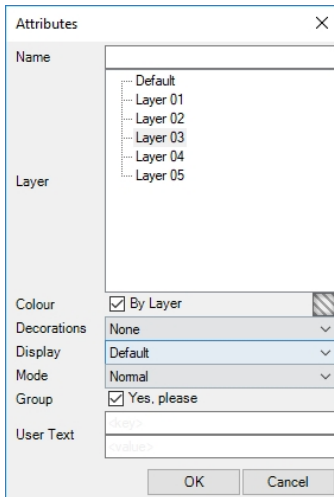

5. In the upper right corner of the Grasshopper canvas, turn off the preview of the Grasshopper geometry.

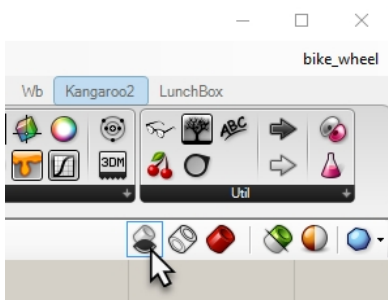

6. Minimize the Grasshopper window by picking the the "-" button in the upper right corner of the Grasshopper Window title bar.
7. You will now see the model in Rhino.
8. Render the wheel.
9. Restore the Grasshopper Window by picking the Restore Up button from the minumized Grasshopper toolbar located in the lower left of the Rhino application window.

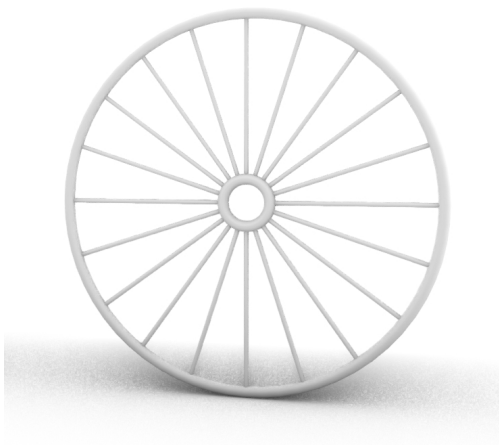

Render the model.



Custom bike by Julie Pedalino and **Pedalino Bicycles**, Lenexa, Kansas.

**Note:** design the bike frame and other features of your bike using Rhino.

See Prof. Steve Jarvis' ART Final Project  
<https://vimeo.com/172640973>

### **Additional Grasshopper Resources**

- [Modelabs Grasshopper Primer, 3rd Ed.](#)  
The Grasshopper Primer 3rd edition, has been translated in four languages, including Spanish, German, Russian.
- [Grasshopper Web Site](#)
- [Grasshopper on the Rhino Support Forum](#)
- [Grasshopper: New in Rhino 6](#)





# Chapter 17 - Transforming solids

It is much easier to model things on a flat plane than it is on an organic surface or any other 3-D shape. Rhino has several tools that allow you to model something in a simple way and then transform it onto a surface or a curve in 3-D space. In this chapter, you will use two commands that do this: **Flow** and **FlowAlongSrf**.

## Flow along surface

The **FlowAlongSrf** command morphs objects from a source surface to a target surface.

Modeling on a curved surface is difficult and hard to achieve accurate results. The **FlowAlongSrf** command simplifies the process by allowing you to model on the flat construction plan first. Then FlowAlongSrf to morphs objects from a source surface to follow target surface.

### Exercise 17-1 Flow solid text

1. **Open** the model **FlowAlongSrf.3dm**
2. On the **Transform** menu, click **Flow Along Surface**.
3. For the **Select objects to flow along a surface**, select the solid text and press **Enter**.  
The text is a group and will select as one.

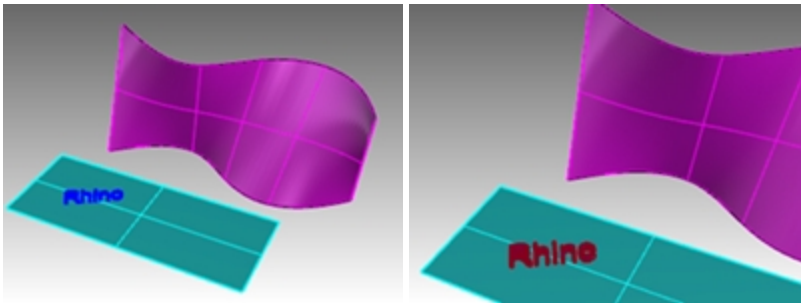

4. For the **Base surface**, select the lower left corner of cyan surface.
5. For the **Target surface**, select the lower left corner of the magenta target surface.  
The text is flowed to the target surface.

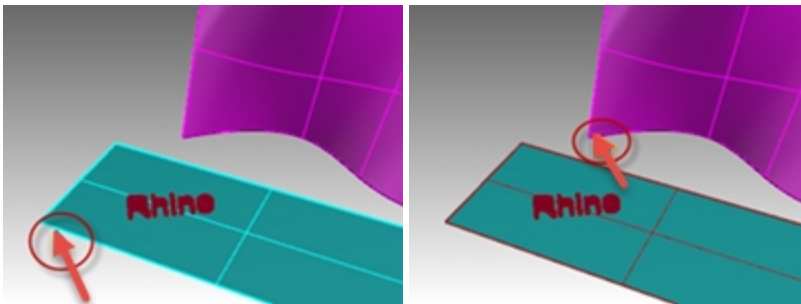

6. **Undo FlowAlongSrf**.

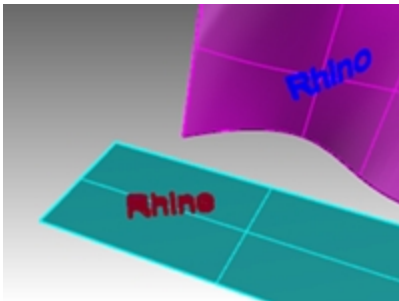

## Surface direction

The success of the FlowAlongSrf depends on the direction of the base and target surface. Each surface has a normal direction, a U direction, and a V direction. Ideally, the normal, U and V directions on the base surface should correspond to the normal, U and V directions on the target surface.

The direction arrow colors are:

- U=Red
- V=Green
- Normal=White

### Check the surface direction

1. Select both the cyan and magenta colored surfaces.
2. On the **Analyze** menu, click **Direction**.
3. At the **Select object to flip direction**, you can click either surface to change the normal direction, press **Enter** when done.

You can use the **NextMode** option to toggle through all of the possible changes to U, V, and Normal directions.

4. If you only need to change one surface, select it and start the **Dir** command again.
5. Make any necessary changes to the direction of the surface so that the U, V, Normal directions match between the two surfaces.

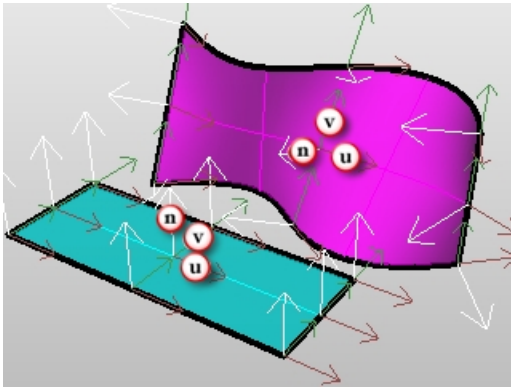

## History and Gumball

Now let's combine FlowAlongSrf with RecordHistory. RecordHistory keeps the objects to be flowed and the objects that have been flowed linked. If the original objects are moved, scaled, or rotated, the flowed objects will update.

### Flow with history and gumball

1. On the **Status Bar** turn on **Gumball** and **RecordHistory**.

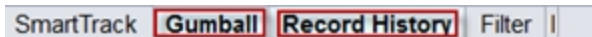

2. On the **Transform** menu, click **Flow Along Surface**.
3. For the **Select objects to flow along a surface**, select the solid text and press **Enter**.

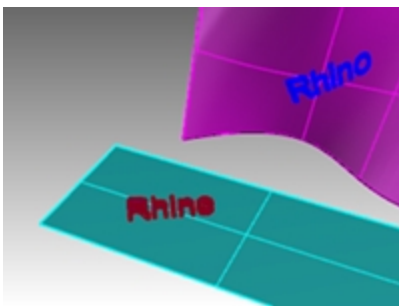

4. For the **Base surface**, select the lower left corner of cyan surface.

- For the **Target surface**, select the lower left corner of the magenta target surface.  
The text is flowed to the target surface.

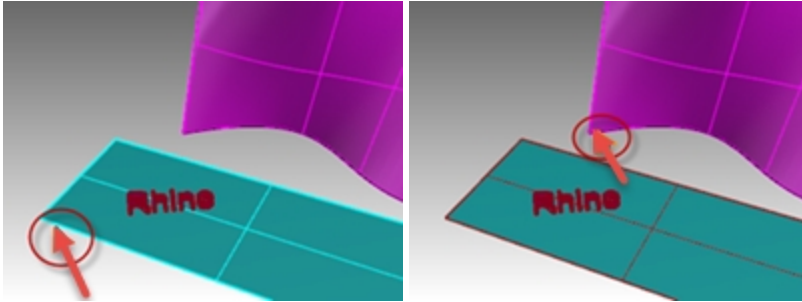

**Note:** The **Record History** pane is toggled off as soon as the **Flow Along Surface** command is complete. By default the **Always Record History** option is not checked. If you want to record history on another command, you will need to select it before you run the next command that supports history.  
See the **Help** for a complete listing of **History Enabled Commands**.

- Select the original text on the base surface.

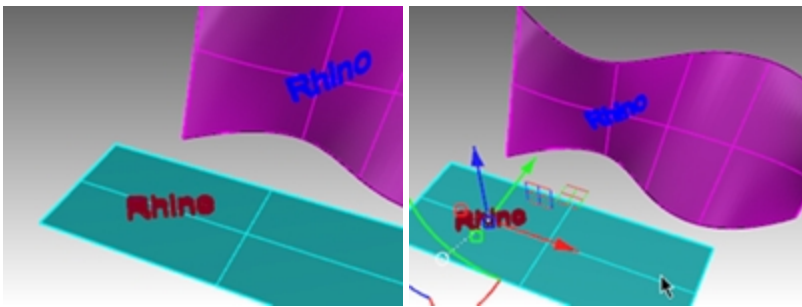

- Use the **Gumball** arrow to move the text to the right.  
Notice that after you release the text on the base surface, the flowed text is updated on the target surface.

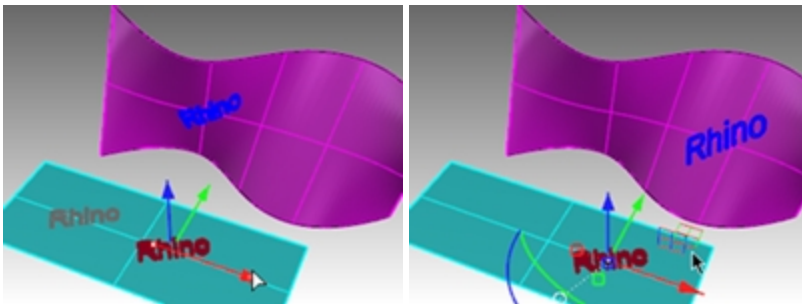

**Note:** If the flowed text does not update, return to step 1 and make sure **Record History** is on before starting **FlowAlongSrf**.

- Select the original text on the base surface.
- Use the **Gumball** arc to rotate the text to the left.
- Release your mouse button and watch the flowed text update.

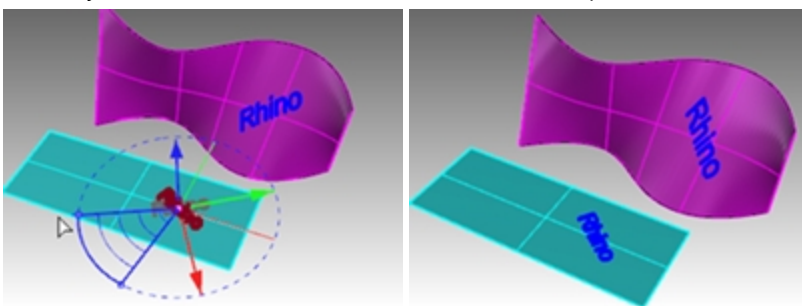

- Select the original text on the base surface.
- Using the **Gumball** red scale handle, and the **Shift** key held down, pull to the handle to the left.

13. Release your mouse and watch the flowed text update.

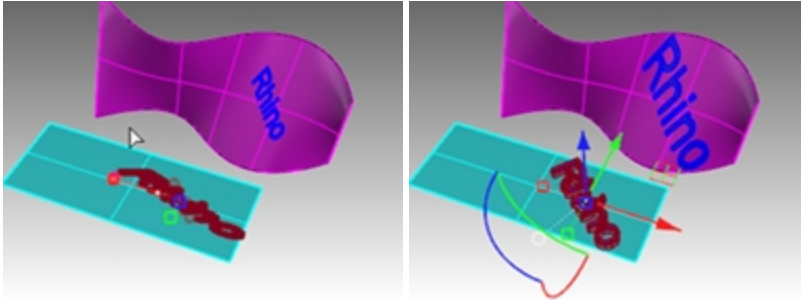

### Flow a logo onto a free-form surface

## Exercise 17-2 Flow logo to penguin

### Create the base surface

1. Open the model **PenguinBrand.3dm**.

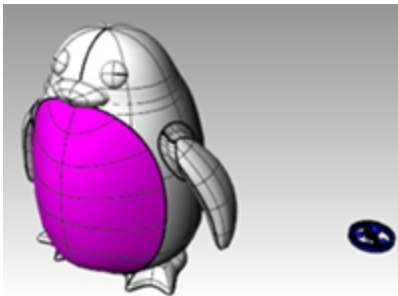

2. On the **Layers** panel, make the **curves** layer current.
3. Select the magenta surface (*front panel*) on the penguin.
4. On the **Curve** menu, click **Curve from Objects**, then **Create UV Curves** and press **Enter**.  
The UV curves are created at the origin of the World XY plane.

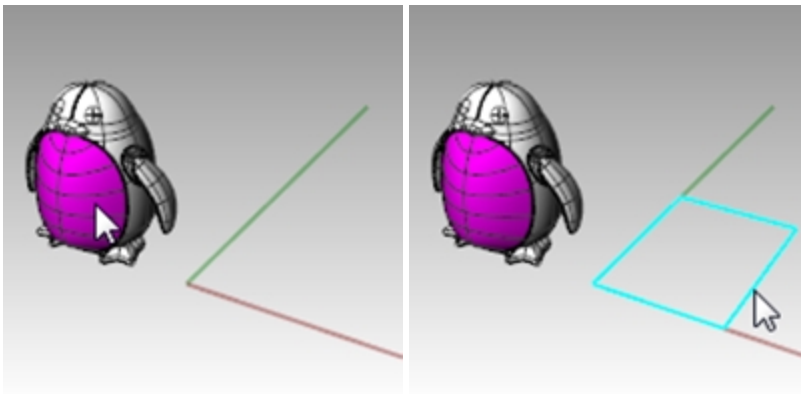

5. On the **Layers** panel, make the **surface** layer current.
6. Select the closed curve, and on the **Surface** menu, click **Planar Curves**.

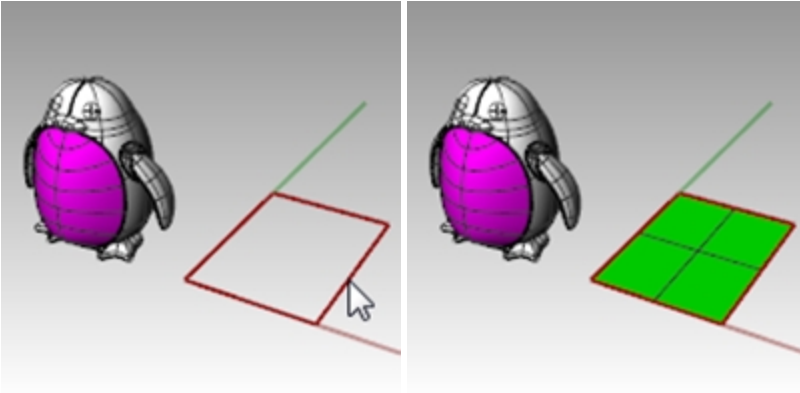

### To flow the Logo

1. Turn on **RecordHistory** on the **Status Bar**.
2. In the **Layers** panel turn on the **logo** layer.  
The logo appears.

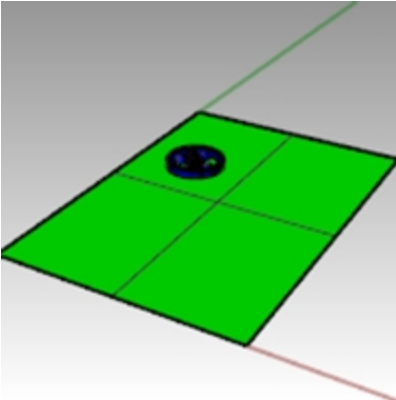

3. Select the logo.

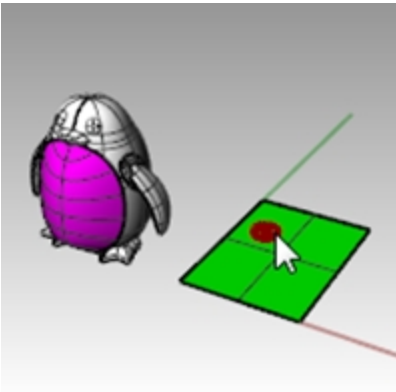

4. On the **Transform** menu, click **Flow Along Surface**.

- For the **Base surface**, select the lower left corner of green surface.

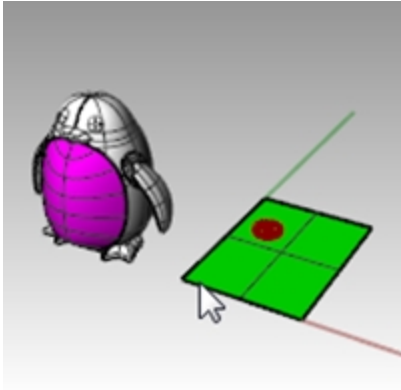

- For the **Target surface**, select the lower left corner of the magenta surface.

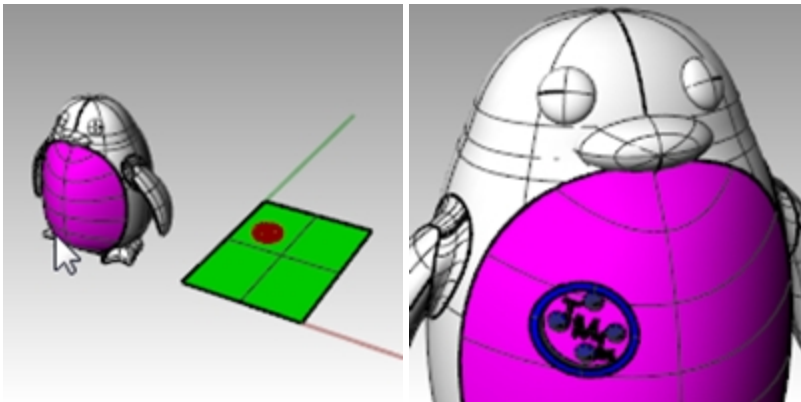

- Turn on **Gumball** on the **Status Bar**.
- Use **Gumball** to **move**, **scale** and **rotate** the original logo on the base surface. The flowed logo updates.

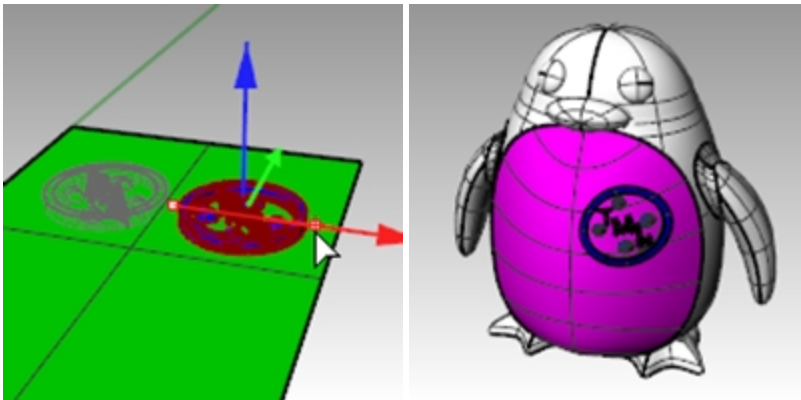

- On the **Render** menu, **Render** to render the model.



## Flow

The **Flow** command re-aligns an object or group of objects from a base curve to a target curve.

### Steps

1. Select objects.
2. Select the base curve near one end.
3. Select the target curve near the matching end.

Similar to Flow Along Surface, the **Flow** command lets you flow solids along a curve. This makes designing in 3-D easier on the construction plane and lets Rhino do all the morphing work.

## Exercise 17-3 Making a Ring with Flow

### Flow the parts of a ring along the shank curve

1. **Open** the model **Flow\_ring.3dm**.
2. Select the green polysurface as the object to flow.
3. On the **Transform** menu, click **Flow along Curve**.

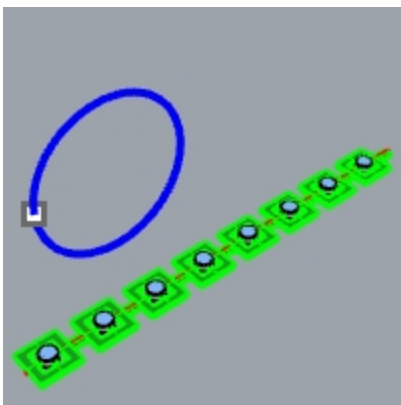

4. For the **Base curve**, select the red linear curve towards the left end.

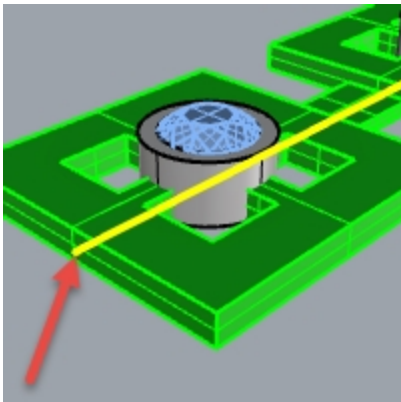

*Base curve.*

5. Stop at this stage and confirm the following option settings in the Command line (**Copy=Yes Rigid=No Stretch=No**).

- As the **Target curve**, select the circle curve slightly below the point location.

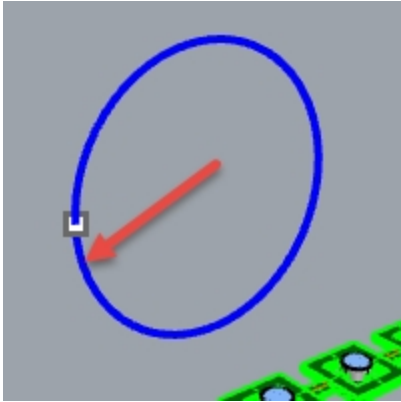

The polysurface is morphed or flowed to the shape of the target curve. Notice that the polysurface doesn't flow completely around the circle.

- Undo.**

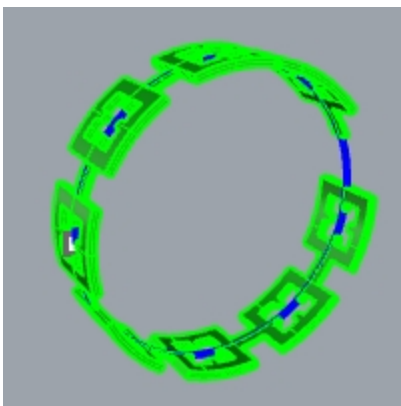

You will flow this polysurface a few more times and use different options. First, you will change the direction of the Flow.

**Flow the parts of a ring along the shank curve in a different direction**

- Repeat **Flow along curve** with identical steps, except select the **Base Curve** near the opposite end.  
**Note:** In the **Perspective** viewport, change the display mode to **Ghosted** to view and select the base curve more easily.

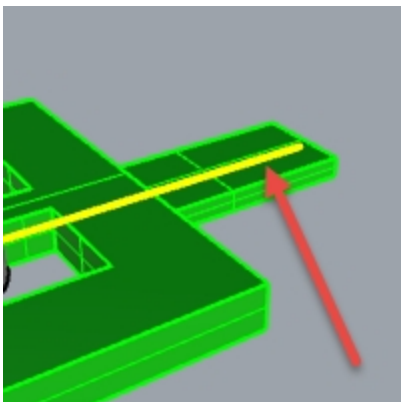

*Base curve.*



- As the **Target curve**, select the circle curve slightly below the point location.

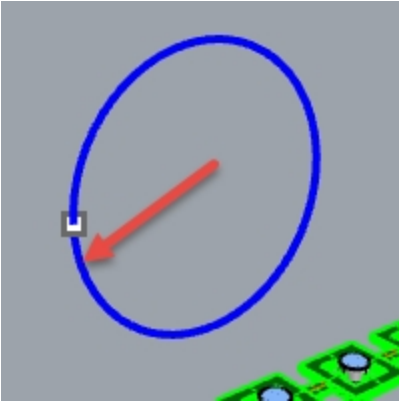

Notice that the inside and outside of the original polysurface has flipped.

- Undo** again.

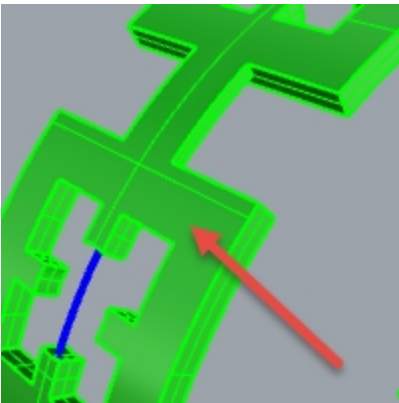

*Bottom of original polysurface is on the outside.*

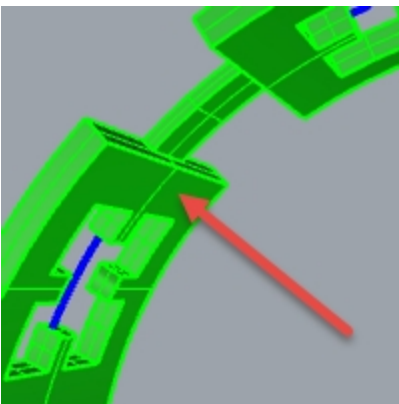

*Top of original polysurface is on the inside.*

Second, you will stretch the original polysurface so that it fits completely around the circle.

### **Flow the parts of a ring along the shank curve, stretching it to fit the whole curve**

- Repeat **Flow along curve** the same way you did it the first time, selecting the **Base Curve** near the left end.  
**Note:** In the **Perspective** viewport, change the display mode to **Ghosted** to view and select the base curve more easily.

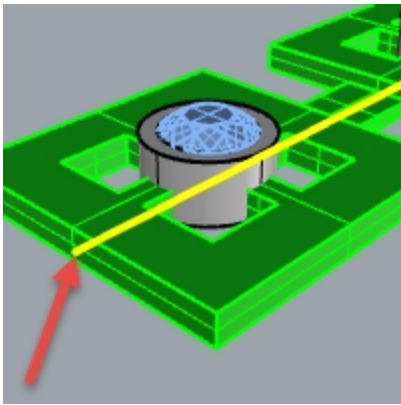

2. Stop at this stage and confirm the following option settings in the Command line (**Copy=Yes Rigid=No Stretch=Yes**).
3. Select the circle curve slightly below the point location as the **Target curve**.

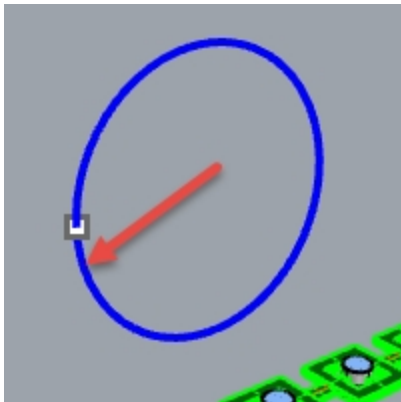

The polysurface is morphed or flowed completely around the circular shape of the target curve.

4. Use the **What** command to confirm that it is a closed solid polysurface.



## Flow the gems and bezels

1. Hide both the original polysurface and the flowed polysurface.
2. On the **Transform** menu, click **Flow along Curve**.
3. For the **Objects to flow**, you will select the gems and bezels by layer.

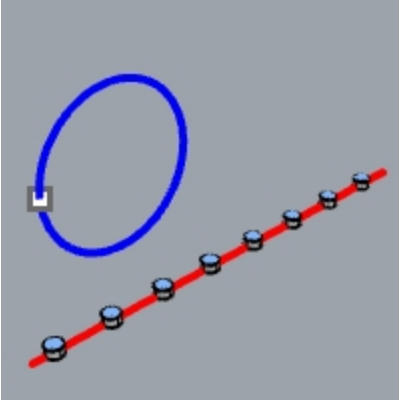

4. In the **Layers** panel, Right click on the **Bezel** layer. Pick **Select objects** from the cursor menu.
5. In the **Layers** panel, right click on the **Gem\_ruby** layer. Pick **Select objects** from the cursor menu.
6. **Enter** to close the object selection.
7. Next, select the **Base Curve** near the left end.
8. Stop at this stage and confirm the following option settings in the Command line:  
**(Copy=Yes Rigid=No Stretch=Yes)**.
9. As the **Target curve**, select the circle curve slightly below the point location.  
The bezels and gems are morphed to fit around the circle.

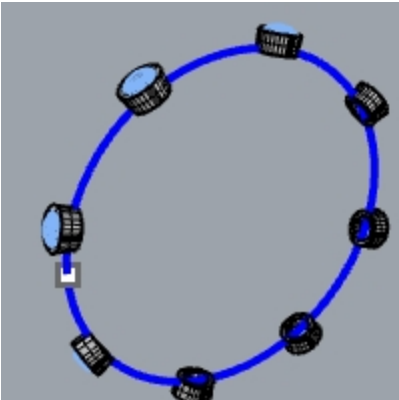

10. Examine the results.  
The sides of the bezels are not perpendicular, the top surface is not flat, and gem is stretched.
11. **Undo**.

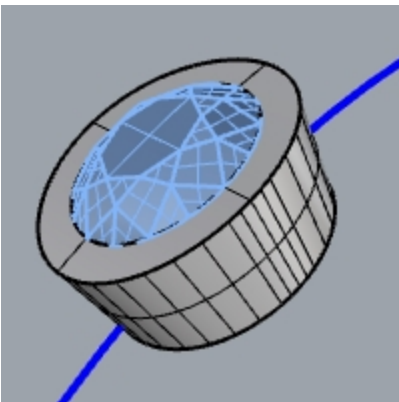

### To flow the gems and bezels with Rigid=Yes

1. On the **Transform** menu, click **Flow along Curve**.
2. For the **Objects to flow**, select the gems and bezels in the **Layers** panel.  
In the **Layers** panel, right-click on the **Bezel** layer. Pick **Select objects** from the cursor menu.  
In the **Layers** panel, right-click on the **Gem\_ruby** layer. Pick **Select objects** from the cursor menu.
3. **Enter** to close the object selection.

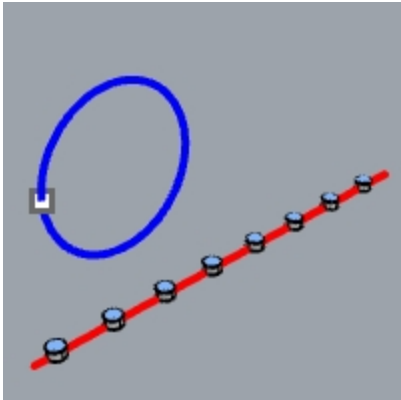

4. Select the **Base Curve** towards the left end.
5. Stop at this stage and confirm the following option settings in the Command line:  
**(Copy=Yes Rigid=Yes Stretch=Yes).**
6. As the **Target curve**, select the circle curve slightly below the point location.  
The bezels and gems are stretched to fit around the circle, but the objects are not deformed.

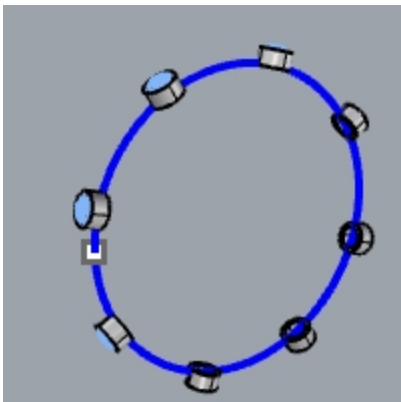

7. Examine the results.  
The sides of the bezels are perpendicular, the top surface is flat, and gem is not stretched.

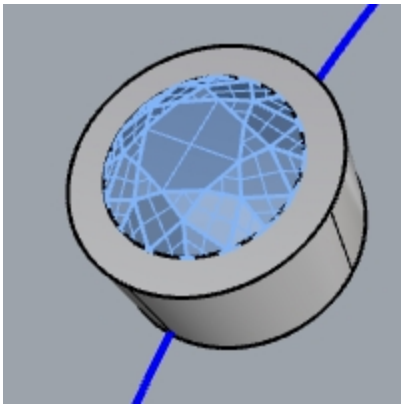

8. **Show** the green polysurface again.

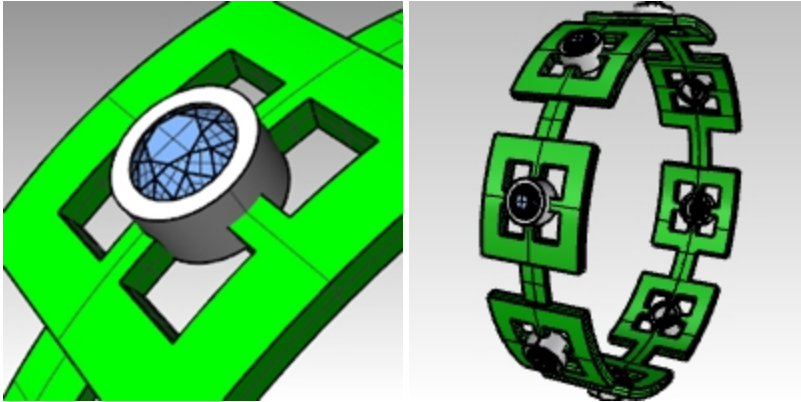

#### View the ring in a rendered viewport

1. On the **View** menu, click **Rendered**.  
A **Ruby** material is assigned to the **Gem\_ruby** layer.  
A **Gold** material is assigned to the **Bezel and Ring** layers.

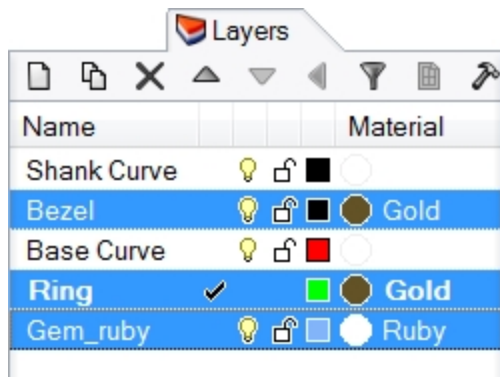

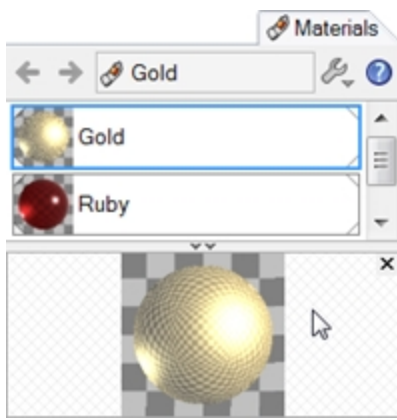

2. **Render** the ring.

